



Parker Legris Rectus Catálogo de Distribución: Soluciones para Baja Presión

Bienvenido a la mundo de Parker Legris y Rectus

Estamos muy orgullosos de presentar nuestro nuevo catálogo. En esta edición encontrará nuestra gama de conexiones de baja presión: racores, acoplamientos, tubos, pistolas de aire y válvulas.

Además de productos destacados, este catálogo ofrece toda la información necesaria para asistir y asesorar a sus clientes.

Dentro del mundo de los productos Parker, nos centramos en dos de nuestras marcas, Legris y Rectus, que son garantía de calidad.

Este catálogo también está disponible en línea en formato digital interactivo. Visite nuestra página web a través del código QR que aparece a continuación.

www.parkerlegris.com
www.parker.com/LPCE



Parker Low Pressure Connectors Europe

Proveedor de soluciones de manejo de fluidos para la automatización y procesos industriales

Desde hace más de 60 años, diseñamos, fabricamos y personalizamos soluciones de conexión rápida seguras y fiables, para su distribución en todo el mundo.

ESTO ES



ESTO ES



NUESTROS VALORES

Inventor de la tecnología "push-to-connect" y líder del mercado de soluciones de acoplamiento rápido, Parker Legris Rectus se enorgullece de su herencia de 60 años de innovación y se mantiene fiel a su valor de productos de alta calidad, respaldados por la excelencia en la fabricación, para garantizar que las necesidades de los clientes sigan siendo su prioridad.

- + EXPERIENCIA:** gente apasionada y liderazgo comprometido
- + EXCELENCIA:** cultura ganadora
- + EXPERIENCIA DEL USUARIO:** valiosos clientes

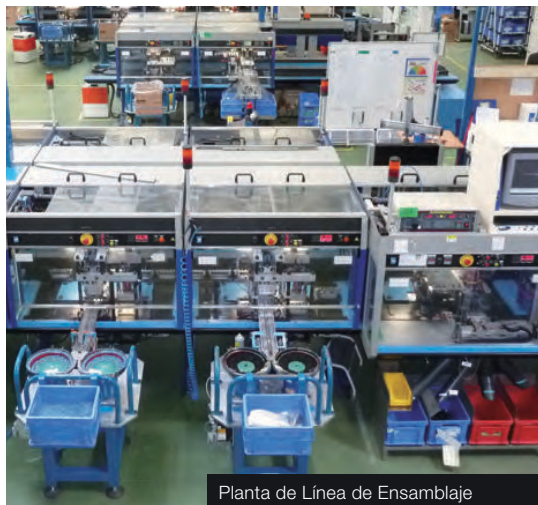

Planta de Línea de Ensamblaje



NUESTROS DIFERENCIADORES

- + UNA PRESENCIA GLOBAL**
- + SOPORTE DE INGENIERÍA PARA EL CLIENTE**
- + INGENIERÍA Y FABRICACIÓN PROPIAS**

NUESTRA GESTIÓN DE CALIDAD

- + IATF 16949, ISO 9001 Y ISO 14001 CERTIFICADO**

NUESTRAS MARCAS





El ADN de Legris & Rectus

Soporte para el cliente

Como socios en sus proyectos, le ofrecemos apoyo y orientación para superar los retos tecnológicos con el fin de desarrollar soluciones totalmente adaptadas al cliente.



Banco de pruebas para medidas de caudal

Servicio de atención al cliente Premium

Como empresa global, ofrecemos un servicio de atención al cliente de primera calidad en cualquiera de sus instalaciones en todo el mundo.



Simulación de ingeniería

Experiencia en ingeniería

Ponemos a su disposición más de 60 años de experiencia en la optimización de la tecnología de flujo, sellado y sujeción.

Excelencia en la fabricación

Nuestro destacado proceso de fabricación en inyección, estampación de latón y montaje automático, garantiza los productos más competitivos.



Caja térmica para el ensayo de envejecimiento

Gestión de la calidad & trazabilidad

Con la certificación ISO, la gestión de la calidad está en el centro de todos nuestros procesos a lo largo de la cadena de valor.



Parker LPCE sede central

Campos de aplicación

Líneas de montaje

RENDIMIENTO ESPERADO:

- Conexión/desconexión frecuente
- Uso seguro
- Compactación
- Alto flujo
- Ligero

RANGOS ADECUADOS DE PARKER LEGRIS Y RECTUS:

- Racores instantáneos LF 3000®, reguladores de caudal
- Enchufes rápidos: Serie KP, 1600 KE, 1700 KE, C 9000
- PA tubo flexible enrollable, tubo flexible enrollable de PU trenzado
- Pistolas sopladoras



MRO (Maintenance, Repair & Operations)

RENDIMIENTO ESPERADO:

- Disponibilidad mundial de productos
- Identificación de productos
- Fiabilidad

RANGOS ADECUADOS DE PARKER LEGRIS Y RECTUS:

- Todas las gamas de racores enchufables
- Accesorios de función
- Todas las series de acopladores de seguridad o enchufes rápidos
- Tubos y mangueras
- Pistolas de aire comprimido



Automatización Industrial

RENDIMIENTO ESPERADO:

- Rendimiento de vacío
- Resistencia mecánica
- Resistencia a la chispa de soldadura

RANGOS ADECUADOS DE PARKER LEGRIS Y RECTUS:

- Racores instantáneos LF 3000®, LF 3600
- Racores funcionales
- Enchufes rápidos metálicos de las series 21, 25, 26
- PA, tubo flexible PU
- Válvulas axiales, válvulas de bola



Campos de aplicación

Bebidas

RENDIMIENTO ESPERADO:

- Resistencia a altas temperaturas
- Cumplimiento de la FDA, NSF, KTW...
- Compactación
- Fácil de limpiar
- Excelente resistencia química y mecánica

RANGOS ADECUADOS DE PARKER LEGRIS Y RECTUS:

- LIQUIfit®, Racores instantáneos LF 3600
- Enchufes rápidos: doble cierre, cara plana
- Tubo de PE avanzado
- LIQUIfit® Válvulas de bola



Proceso de enfriamiento

RENDIMIENTO ESPERADO:

- Optimización de los circuitos
- Garantizar la durabilidad de los equipos
- Mejorar la productividad
- Simplificar el mantenimiento de las máquinas
- Flujo máximo

RANGOS ADECUADOS DE PARKER LEGRIS Y RECTUS:

- LIQUIfit® con adaptadores metálicos, racores instantáneos LF 3800, cartuchos Carstick®
- Accesorios funcionales de acero inoxidable
- Enchufes rápidos: serie 200KL, 200KLEK, serie 21, 70, 48
- PE, FEP, tubo PU anti-chispas
- Válvulas de bola manuales, válvulas pilotadas, accesorios



Ciencias de la vida

RENDIMIENTO ESPERADO:

- Compatible con la manipulación de oxígeno
- No hay contaminación de fluidos
- Conexiones rápidas seguras
- Cumplimiento de la normativa sanitaria

RANGOS ADECUADOS DE PARKER LEGRIS Y RECTUS:

- Racores instantáneos LF 6800, LF 3800, LIQUIfit®
- Enchufes rápidos termoplásticos: series 21, 48,
- PFA, PU clean, FEP, tubos de PE
- Válvulas de bola compatibles con el oxígeno



Campos de aplicación

Seguridad

RENDIMIENTO ESPERADO:

- Seguridad de los operadores y del equipo
- Calidad y durabilidad de los productos
- Cumplimiento de la directiva 2006/42/CE y ISO 13849-1-1

RANGOS ADECUADOS DE PARKER LEGRIS Y RECTUS:

- Racores de bloqueo y válvulas antirretorno pilotadas
- Racores de arranque suave
- Enchufes rápidos de seguridad
- Pistolas de aire comprimido
- Válvulas de bola bloqueables y ventiladas



Proceso Alimentario

RENDIMIENTO ESPERADO:

- Cumplimiento de la FDA
- Fácil de limpiar
- Compatibilidad química
- Resistencia a altas temperaturas

RANGOS ADECUADOS DE PARKER LEGRIS Y RECTUS:

- LIQUIfit®, Racores instantáneos LF 3600, LF 3800
- Racores funcionales de acero inoxidable
- Enchufes rápidos de acero inoxidable, de cierre simple o doble Serie 20KA, 21KA, 25KA
- Tubos de FEP, PE avanzado y PFA



Ferrocarril

RENDIMIENTO ESPERADO:

- Resistencia a las vibraciones
- Cumplimiento de las normas: DIN EN61373, CE 61373
- Amplio rango de temperaturas de -60°C a +170°C

RANGOS ADECUADOS DE PARKER LEGRIS Y RECTUS:

- Racores instantáneos LF 3000®, LF 3600
- Reguladores de caudal, válvulas antirretorno, reguladores de presión, racores de arranque suave, silenciadores
- Racores de latón de compresión y de latón niquelado
- Válvulas de bola, serie universal
- Tubos de PA, PE a prueba de fuego
- LIQUIfit® y válvulas de bola de acero inoxidable



Regulaciones para adaptarse a los requisitos de calidad del mercado

Para todas las aplicaciones industriales



UL94



ISO 14743*

IP68



SUVA pro

DVGW

(Juntas tóricas en el tratamiento de gases)

Para el proceso
de alimentos



Para las bebidas



**KTW
W270**



Para aplicaciones
médicas y de
salas limpias



**USP
Class VI (A)**

ASTM G93

ISO 15001

Para los
ferrocarriles



EN 45545-2

DIN 5510-2

NF F16-101

*excepto el capítulo 9.8

La información sobre las normas y reglamentos no es contractual, sólo los certificados entregados a petición son auténticos.

Gestión de la calidad y trazabilidad



Con la certificación ISO, la gestión de la calidad está en el centro de todos nuestros procesos a lo largo de la cadena de valor.

- Garantizamos la calidad y la trazabilidad de cada conector que vendemos
- Nuestros productos están 100% probados contra fugas
- La inspección por cámara comprueba la conformidad de los anillos de agarre de nuestros productos Legris
- Certificados disponibles en línea



Nuestra prioridad: Seguridad del operador y del equipo

Objetivo: 0 accidentes

Componentes dentro del sistema de control de seguridad



Componentes fuera del sistema de control de seguridad



Máquina segura



Todos los datos de seguridad están disponibles en la hoja de datos de seguridad en Parkerlegris.com y parker.com/LPCE



WASTE

Los miembros del equipo de Parker aplican sus conocimientos técnicos y su creatividad

- para simplificar procesos de fabricación complejos
- reducir los residuos de producción
- diseñar productos y sistemas que equilibren de forma precisa el rendimiento y la eficiencia.



CO₂



Esta estrategia cumple con la responsabilidad compartida de resolver los retos de los clientes y al mismo tiempo minimizar el impacto ambiental.



Enchufes o Racores ? Ofrecemos todas las soluciones





Frecuencia de conexión/desconexión

-  Conexión/desconexión frecuente: hasta 10.000 veces
-  Sólo unas pocas desconexiones: hasta 5 veces (antes de acortar el tubo)





Indicador de conexión total

-  Un "clic" audible indica la conexión
-  "Parada final del tubo" cuando está completamente conectado





Tubo o conexión de la manguera

-  Se utiliza con la conexión de la púa de la manguera
-  Se utiliza con la conexión de la manguera





Resistencia a la tracción

-  Todos los sistemas de cierre ofrecen una alta resistencia a la fuerza de tracción
-  La tecnología de pinza de sujeción proporciona resistencia a la fuerza de tracción en los tubos rígidos ranurados





Desconexión bajo presión

-  Autoriza la autoventilación o las opciones de doble cierre
-  No se recomienda para la desconexión bajo presión



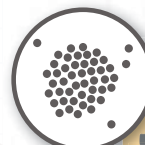

Sin goteo

-  Tecnología de cara plana, una solución para los requisitos de caída cero
-  Prefiere una solución de acoplador, doble cierre y cara plana





Ocupación del espacio

-  Ver serie 02: D.I. 1,5 mm
-  Ver LF 3000® D.O. 3 mm





Ligero

-  Los acopladores de compuestos técnicos ofrecen una solución ligera
-  Una solución para el ahorro de peso





Robustez

-  Consulte las series de latón o acero inoxidable
-  Consulte las gamas de racores metálicos o de polímero reforzado





Presión

-  250 bar (serie 70 de acero inoxidable)
-  550 bar (accesorios de compresión)







Flujo

-  Hasta 17.000 NI/min para acoplamientos directos
-  Tecnología de flujo completo



Temperatura

-  Hasta +240°C, junta de FFKM
-  Hasta 150°C, junta de FKM

Racores	Racores instantáneos					
	 LF 3000® p.18	 LF 3200 p.41	 LIQUIfit® p.43	 LIQUIfit* adaptador metálico p.55	 LF 3600 p.60	
	Racores con funciones					
	 Reguladores de control de flujo de polímeros p.90	 Reguladores metálicos de control de flujo p.99	 Racor de bloqueo p.111	 Válvulas de escape pilotadas sin retorno, metálica p.113	 Válvulas antirretorno p.117	
	Racores de compresión					
	 Racores de latón p.137	 Racores de acero inoxidable p.151	 Racores PL p.157			
	Accesorios de conexión					
	 Latón y Latón niquelado p.163	 Adaptores de latón p.168	 Acero inoxidable p.173	 Regletas de distribución p.176	 Tapones p.177	
	Enchufes	Latón y Latón niquelado	Acero inoxidable	Termoplástico	Accesorios	
		 Latón y latón niquelado p.200	 Acero inoxidable 303/316L p.281	 POM/PVDF p.297	 p.308	
Seguridad			Sistemas codificados	Molde		
 Norma de seguridad p.313		 Acoplamiento para aire respirable p.318	 Acoplamiento autoventilado p.322	 Series 21/25 p.349	 Latón y latón niquelado p.358	
Poliamida		Poliuretano	Polietileno	Fluoropolímero	En espiral	
 PA, Incombustible, Antichispas p.394	 PU, Antichispas, Antiestático p.398	 PE Avanzado, PE p.403	 FEP, PFA p.405	 PA, PU, Espirales p.408		
Válvulas industriales	Válvulas de Bola					
	 Universal p.444	 Universal Ligera p.449	 DVGW p.451	 Estándar p.452	 Acero inoxidable p.454	

Racores instantáneos					Racores
 p.68 LF 3600 con bajo contenido en plomo	 p.71 LF 3800	 p.77 LF 6800	 p.80 LF 6100	 p.82 Accesorios	
Racores con funciones					
 p.123 Racores de arranque progresivo & reguladores	 p.127 Racor captador neumático y de intervención	 p.131 Válvulas de mando manual	 p.133 Silenciadores		
Accesorios de conexión					
 p.182 Estanqueidad					
Sellado plano					Enchufes
 p.309 Latón, acero inoxidable					
Tubo para Molde	Agua				
 p.379 EPDM, PKR, PVC	 p.381 Latón niquelado				
Trenzado	Accesorios	Pistolas y Boquillas		Tubos & pistolas	
 p.415 PVC	 p.421 Clips, Abrazadera de apriete, Cortatubos	 p.427 Polímero	 p.430 Boquillas		 p.432 Metálicas
Aguja y Mariposa				Válvulas axiales	Válvulas industriales
 p.456 Alta presión	 p.457 Mini Válvulas de Bola	 p.459 LIQUIfit®	 p.460 de punzón y lenticular	 p.463	

#01

RACORES

Racores instantáneos

Racores con funciones

Racores de compresión

Accesorios de conexión



Cómo elegir sus racores

Puntos clave a considerar antes de elegir su conector industrial

¿Qué función necesita?

- Proteja su sistema
- Detectar el final de la carrera del vástago del cilindro
- Controlar y mejorar el rendimiento de su sistema
- Trabajando en su sistema

¿Qué tipo de fluido se está transportando?

- La compatibilidad de los materiales de sellado y de los conectores con el fluido

¿Cuáles son las condiciones de uso?

- Vacío
- Presión
- Temperatura del fluido
- Con o sin sello
- Requisitos de flujo

¿Qué tipo de rosca necesitas?

- Rosca macho/rosca hembra
- BSPP, BSPT, NPT, métrica

¿Qué conector necesitas?

- Racores instantáneos
- Racores de compresión
- Racores de cánula
- Accesorios de conexión

¿Tiene requisitos de reglamentaciones?

- Normas y reglamentos
- ISO 9001/ISO TS 16949 ; RoHS, FDA, NSF
- Sin silicona, sin ftalatos, etc...
- Materiales compatibles con la aplicación
- Compatibilidad química

¿Cuál es su aplicación?

- Calidad del aire ambiente (contaminación)
- Riesgo de choques
- Zonas confinadas/dificultades de acceso
- Usos externos (UV, ambientes salinos)
- Uso de productos en equipos móviles

¿Ha pensado en los requisitos adicionales del producto?

- Tubo
- Válvulas industriales
- Enchufes
- Pistolas industriales

Generalidades técnicas

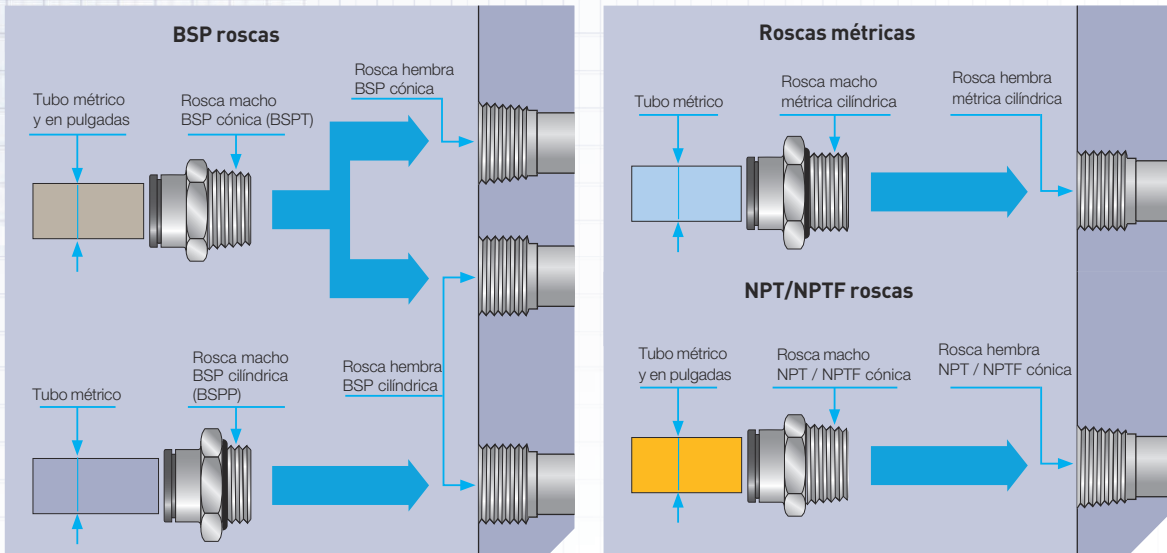

Racores instantáneos

Sujeción mediante arandela

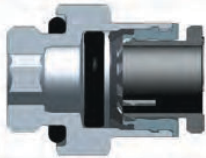

- Sin daños en el tubo
- Ideal para los tubos de polímero
- Especialmente compacta

Sujeción mediante pinza

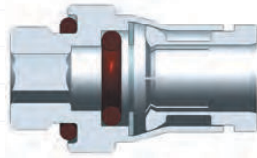

- Solución muy robusta para los ambientes agresivos
- Resiste las fuertes presiones, muy buena resistencia
- Ideal para los tubos metálicos ranurados

Sujeción mediante pinza invertida

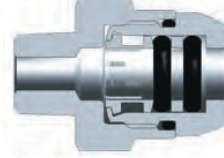

- Desconexión segura
- Resiste presiones muy fuertes
- Doble estanqueidad

Ventajas

Permite realizar rápidamente sistemas flexibles y modulares.
Garantiza una solución de conexión compacta y ligera.
Facilita la instalación gracias a una conexión orientable.
Hace fiable la conexión gracias a su diseño monobloque.

Hace posible el uso de una amplia gama de tubos.
Prolonga la estanqueidad de sus sistemas.

Racores de compresión de anillo

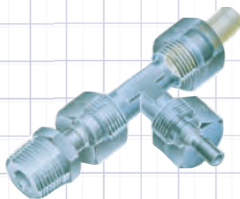

Conexión y estanqueidad realizadas mediante el engaste de un anillo metálico en un tubo.
El sistema de estanqueidad es metal / metal.

Ventajas

Resiste presiones y temperaturas muy elevadas.
Permite las conexiones de todos los tipos de tubos, polímeros y metálicos.
Aumenta la vida útil de la conexión.

Racores de compresión de cánula

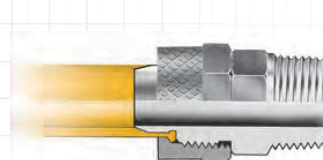

Conexión y estanqueidad realizadas mediante la deformación y el enganche de un tubo plástico.

Ventajas

Dedicado a la conexión de tubos muy flexibles o no calibrados.

Identificación de nuestras referencias

Los números de referencia se eligen según un código nemotécnico.

Cada racor y válvula se identifica por::

- la serie del modelo (4 cifras)
- el diámetro nominal (2 cifras)

Racores

3101 06 10

Tipo de artículo

Ø nominal

Código de la rosca

Código del Ø nominal: corresponde al Ø exterior del tubo.
Código de la rosca: ver tablas página 12.
Cuando el producto no lleva rosca, el código utilizado es: 00.

3101 Racor de entrada recto, rosca macho BSPP y métrica

Latón niquelado, NBR



Encontrará el tipo de pieza en la parte superior de cada tabla

Identificación de las roscas en las referencias

Rosca BSPP	Código	Rosca NPT / NPTF	Código
1/8"	10	1/16"	08
1/4"	13	1/8"	11
3/8"	17	1/4"	14
1/2"	21	3/8"	18
3/4"	27	1/2"	22
1"	34	3/4"	28
1 1/4"	42	1"	35
1 1/2"	49	1 1/4"	43
2"	48	1 1/2"	50
		2"	44

Rosca métrica	Código	Rosca métrica	Código	Rosca métrica	Código
M3x0,5	09	M12x1,25	66	M22x1,5	82
M5x0,8	19	M12x1,5	67	M24x1,5	83
M6x1	52	M13x1,25	68	M27x1,5	85
M7x1	55	M14x1,25	70	M30x2	88
M8x1	56	M14x1,5	71	M33x1,5	90
M8x1,25	57	M16x1,25	74	M39x1,5	36
M10x1	60	M16x1,5	75	M42x1,5	37
M10x1,5	62	M18x1,5	78	M42x2	96
M12x1	65	M20x1,5	80	M48x2	98

Descripción de las especificaciones del producto

	Materiales	Fluidos	Presión máxima (bar)	Temperaturas		Resistencia en entornos agresivos		Página
				Min.	máx.	Mecánica	Química	
Racores instantáneos								
 <p>LF 3000®</p>	Polímero técnico/ Latón niquelado NBR	Aire comprimido	20	-20°C	+80°C	Buena	Moderada	18
 <p>LF 3200</p>	Latón niquelado NBR	Aire comprimido	20	-15°C	+80°C	Excelente	Moderada	41
 <p>LIQUIfit®</p>	Polímero de origen biológico/EPDM	Líquidos	16	-10°C	+95°C +130°C bajo condiciones	Moderada	Excelente	43
 <p>LIQUIfit® con el adaptador de metal</p>	Polímero de origen biológico/latón niquelado FDA/acero inoxidable 316L/EPDM	Líquidos	16	-10°C	+130°C para Ø4,6 y 8mm	Moderada	Excelente	55
 <p>LF 3600</p>	Latón niquelado FDA/FKM	Todos los fluidos compatibles	30	-25°C	+150°C	Excelente	Buena	60
 <p>LF 3600 latón con bajo contenido de plomo</p>	Latón con bajo contenido de plomo FDA/FKM	Todos los fluidos compatibles; agua	30	-25°C	+150°C	Excelente	Buena	68
 <p>LF 3800</p>	Acero inoxidable 316L/FKM	Todos los fluidos	30	-25°C	+150°C	Excelente	Excelente	71
 <p>LF 6800</p>	Latón niquelado EPDM	O ₂ , gases analíticos	15	-10°C	+95°C	Moderada	Excelente	77
 <p>LF 6100</p>	Latón/NBR	Todos los fluidos compatibles	60	-40°C	+120°C	Excelente	Excelente	80

Racores instantáneos LF 3000® / Racores de implantación



Una gama de racores de polímero técnico para cubrir la mayoría de las necesidades de las aplicaciones neumáticas de baja presión.

Ø métrico: 3 a 16 mm
Ø pulgadas: 1/8" a 1/2"

Características técnicas

- **Fluidos adecuados:** Aire comprimido
Otros fluidos: consúltenos
- **Presión de trabajo:** De vacío hasta 20 bar
- **Temperatura de trabajo:** -20°C a +80°C

Par de apriete (daN.m)	Roscas								
	M3 x0,5	M5 x0,8	M7 x1	M10 x1	M12 x1,5	G1/8	G1/4	G3/8	G1/2
	0,06	0,16	0,8	0,8	1,1	0,8	1,2	3	3,5

Las prestaciones dependen de los fluidos, del material y del tubo utilizados. El uso está garantizado para un vacío de 755 mm Hg (99% de vacío).

Ventajas del producto

- Robusto, ligero y compacto para construir sus circuitos neumáticos
- Conexiones de flujo completo para optimizar las tasas de caudal
- Se usa tanto en vacío como en aire comprimido

Materiales

Sin silicona

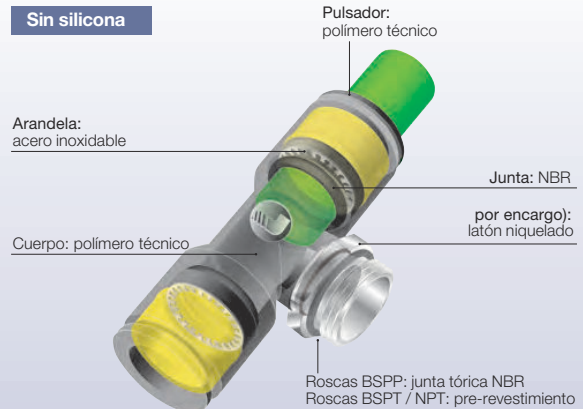

Reglamentaciones

- ISO 14743
- PED
- RoHS
- REACH

3175 Racor de entrada recto, rosca macho BSPT

Latón niquelado, NBR

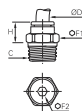

ØD	C	F1	F2	H	Kg
4	R1/8 3175 04 10	10	3	9,5	0,005
	R1/4 3175 04 13	14	3	6,5	0,011
	R3/8 3175 04 17	17	3	8	0,024
6	R1/8 3175 06 10	11	4	11,5	0,005
	R1/4 3175 06 13	14	4	8,5	0,011
	R3/8 3175 06 17	17	4	8,5	0,021
8	R1/2 3175 06 21	21	4	9	0,043
	R1/8 3175 08 10	13	5	20	0,011
	R1/4 3175 08 13	14	6	17	0,014
10	R3/8 3175 08 17	17	6	13	0,021
	R1/2 3175 08 21	21	6	12	0,039
	R1/8 3175 10 10	16	5	22,5	0,017
12	R1/4 3175 10 13	16	7	20	0,017
	R3/8 3175 10 17	17	8	16,5	0,019
	R1/2 3175 10 21	21	8	14	0,036
14	R1/4 3175 12 13	19	7	26,5	0,029
	R3/8 3175 12 17	19	9	24	0,028
	R1/2 3175 12 21	21	10	19,5	0,036
16	R3/8 3175 14 17	22	9	28,5	0,044
	R1/2 3175 14 21	24	10	23,5	0,046
	R3/8 3175 16 17	27	9	32,5	0,068
	R1/2 3175 16 21	27	12	32,5	0,079

Rosca con "pre-coating"

3175 Racor de entrada recto, rosca macho NPT

Latón niquelado, NBR

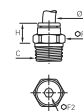

ØD	C	F1	F2	H	Kg
6	NPT1/8 3175 06 11	11	4	11,5	0,006
	NPT1/4 3175 06 14	14	4	8,5	0,012
10	NPT1/4 3175 10 14	16	7	20	0,018
	NPT3/8 3175 10 18	18	8	16,5	0,023
12	NPT1/2 3175 10 22	22	8	14	0,038
	NPT3/8 3175 12 18	19	9	24	0,030
	NPT1/2 3175 12 22	22	10	19,5	0,037

Rosca con "pre-coating"
5/32"(4 mm) y 5/16"(8 mm) también disponible

Racores instantáneos LF 3000® / Racores de implantación



3175 Racor de entrada recto, rosca macho NPT Pulgadas

Latón niquelado, NBR

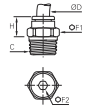

ØD	C		F1	F2	H	Kg
1/8	NPT1/8	3175 53 11	11	2	7,2	0,006
	NPT1/4	3175 53 14	14	2	8	0,015
1/4	NPT1/8	3175 56 11	11	4	11,9	0,007
	NPT1/4	3175 56 14	14	4	9,4	0,013
3/8	NPT3/8	3175 56 18	18	5	7,6	0,024
	NPT1/8	3175 60 11	16	4	22,7	0,019
1/2	NPT1/4	3175 60 14	16	7	20,5	0,019
	NPT3/8	3175 60 18	18	7	17,5	0,026
3/4	NPT3/8	3175 62 18	22	9,5	25,9	0,048
	NPT1/2	3175 62 22	24	9,5	22,1	0,064

Rosca con "pre-coating"

3175 Racor de entrada recto, rosca macho BSPT Pulgadas

Latón niquelado, NBR

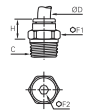

ØD	C		F1	F2	H	Kg
1/8	R1/8	3175 53 10	11	3	8,5	0,005
	R1/8	3175 55 10	11,1	3,2	15,5	0,009
3/16	R1/4	3175 55 13	14,3	4	15	0,020
	R1/8	3175 56 10	11	4	12	0,006
1/4	R1/4	3175 56 13	14	4	9,5	0,021
	R1/4	3175 60 13	16	7	20,5	0,018
3/8	R3/8	3175 60 17	17	7	16,5	0,019
	R1/2	3175 60 21	21	7	14	0,037
1/2	R1/4	3175 62 13	22	6	26,9	0,044
	R3/8	3175 62 17	22	7	25,9	0,048
3/4	R1/2	3175 62 21	24	7	20,5	0,049

Rosca con "pre-coating"

3101 Racor de entrada recto, rosca macho BSPP y métrica

Latón niquelado, NBR

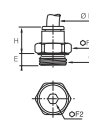

ØD	C		E	F1	F2	H	Kg
3	M3x0,5	3101 03 09*	2,5	8		12,5	0,003
	M5x0,8	3101 03 19	3,5	8	2,5	12,5	0,004
4	M3x0,5	3101 04 09*	2,5	8		14,5	0,003
	M5x0,8	3101 04 19	3	9	2,5	14	0,004
6	M7x1	3101 04 55	5	10	2,5	14	0,004
	G1/8	3101 04 10	5	13	3	11,5	0,007
8	G1/4	3101 04 13	5,5	16	3	10,5	0,011
	M5x0,8	3101 06 19	3,5	11	2,5	16	0,005
10	M7x1	3101 06 55	5	10	3	16	0,006
	M10x1	3101 06 60	5	13	4	13	0,007
12	M12x1,5	3101 06 67	5,5	15	4	13	0,009
	G1/8	3101 06 10	5	13	4	13	0,007
14	G1/4	3101 06 13	5,5	16	4	12,5	0,011
	G3/8	3101 06 17	5,5	20	4	13	0,020
16	G1/2	3101 06 21	7	24	4	20	0,039
	M10x1	3101 08 60	5	13	5	21	0,011
18	M12x1,5	3101 08 67	5,5	15	5	21	0,015
	G1/8	3101 08 10	4,5	13	5	20,5	0,011
20	G1/4	3101 08 13	5,5	16	6	19,5	0,016
	G3/8	3101 08 17	5,5	20	6	18	0,022
22	G1/2	3101 08 21	7	24	6	16,5	0,038
	G1/4	3101 10 13	5,5	16	7	23	0,018
24	G3/8	3101 10 17	5,5	20	8	19,5	0,021
	G1/2	3101 10 21	7	24	8	18,5	0,033
26	G1/4	3101 12 13	5,5	19	7	27,5	0,027
	G3/8	3101 12 17	5,5	20	9	27	0,028
28	G1/2	3101 12 21	7	24	11	22,5	0,035
	G3/8	3101 14 17	5,5	22	9	29,5	0,041
30	G1/2	3101 14 21	7	24	11	28	0,046
	G3/8	3101 16 17	7,5	27	9	32,5	0,061
32	G1/2	3101 16 21	9	27	12	32,5	0,068

* Con junta bi-materia

3181 Racor de entrada recto hexagonal interior, rosca macho métrica

Latón niquelado, NBR

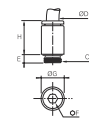

ØD	C		E	F	G	H	Kg
4	M5x0,8	3181 04 19	3,5	2,5	8,5	14,5	0,003
	M7x1	3181 04 55	5	3	10	14	0,004
6	M5x0,8	3181 06 19	3,5	2,5	11	16,5	0,005
	M7x1	3181 06 55	5	3	10	16	0,005

Gracias a su hexágono interior y su forma exterior redonda, el modelo 3181 asegura diseños muy compactos.

El uso de una llave Allen para el montaje permite que se instale en lugares difíciles.

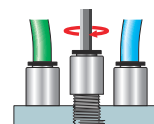

Racores instantáneos LF 3000® / Racores de implantación

3114 Racor de entrada recto, rosca hembra BSPP y métrica

Latón niquelado, NBR



ØD	C		E	F	H	Kg
4	M5x0,8	3114 04 19	6,5	8	19,5	0,005
	G1/8	3114 04 10	9,5	13	22,5	0,010
6	G1/4	3114 04 13	13,5	16	26,5	0,015
	G1/8	3114 06 10	9,5	13	24,5	0,011
8	G1/4	3114 06 13	13,5	16	28,5	0,016
	G1/8	3114 08 10	9,5	13	29	0,015
10	G1/4	3114 08 13	13,5	16	33	0,021
	G3/8	3114 08 17	14	19	34	0,025
12	G1/4	3114 10 13	13,5	16	36	0,028
	G3/8	3114 10 17	14	19	36	0,027
14	G1/2	3114 10 21	19,5	24	41,5	0,047
	G3/8	3114 12 17	14	19	40	0,033
16	G1/2	3114 12 21	19,5	24	45,5	0,052
	G3/8	3114 14 17	14	22	42,5	0,057
16	G1/2	3114 16 21	15	27	49	0,096

3131 Adaptador, rosca macho BSPP y métrica

Polímero técnico, Latón niquelado, NBR

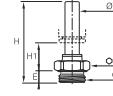

ØD	C		E	F	H	H1	Kg
4	M5x0,8	3131 04 19	3,5	8	31	16	0,002
	G1/8	3131 04 10	5	13	30	13,5	0,005
6	G1/4	3131 04 13	5,5	16	31	13,5	0,010
	G1/8	3131 06 10	5	13	32	13,5	0,005
8	G1/4	3131 06 13	5,5	16	33	13,5	0,010
	G1/8	3131 08 10	5	13	35,5	12,5	0,008
10	G1/4	3131 08 13	5,5	16	34,5	10,5	0,010
	G3/8	3131 08 17	5,5	20	34,5	10,5	0,015
12	G1/4	3131 10 13	5,5	16	43,5	17,5	0,012
	G3/8	3131 10 17	5,5	20	41,5	15,5	0,015
14	G1/2	3131 10 21	7	24	41,5	15,5	0,024
	G3/8	3131 12 17	5,5	20	42	12	0,015
14	G1/2	3131 12 21	7	24	43,5	12	0,024
	G3/8	3131 14 17	5,5	20	46,5	14	0,016
14	G1/2	3131 14 21	7	24	48	13,5	0,025

3121 Adaptador enclavable, rosca macho BSPT

Polímero técnico, Latón niquelado



ØD	C		F	H	H1	Kg
4	R1/8	3121 04 10	10	26	14	0,005
	R1/4	3121 04 13	14	26,5	14,5	0,014
6	R1/8	3121 06 10	10	28	14	0,005
	R1/4	3121 06 13	14	28,5	14,5	0,014
8	R1/8	3121 08 10	10	29,5	11	0,005
	R1/4	3121 08 13	14	28,5	10	0,012
10	R1/4	3121 10 13	15	36	15,5	0,012
	R3/8	3121 10 17	17	36	15,5	0,017
12	R1/2	3121 10 21	21	36	15,5	0,032
	R3/8	3121 12 17	17	36,5	12	0,018
12	R1/2	3121 12 21	21	36,5	12	0,030

Rosca con "pre-coating"

3109 Codo, rosca macho BSPT

Polímero técnico, Latón niquelado, NBR

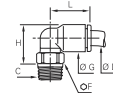

ØD	C		F	G	H	L	Kg
4	R1/8	3109 04 10	10	8,5	13,5	14	0,006
	R1/4	3109 04 13	14	8,5	14	14	0,015
6	R3/8	3109 04 17	17	8,5	13,5	14	0,019
	R1/8	3109 06 10	10	10,5	15,5	16	0,006
8	R1/4	3109 06 13	14	10,5	16	16	0,015
	R3/8	3109 06 17	17	10,5	16	16	0,020
10	R1/2	3109 06 21	21	10,5	16,5	16	0,035
	R1/8	3109 08 10	10	13,5	19	23	0,007
12	R1/4	3109 08 13	14	13,5	18	23	0,014
	R3/8	3109 08 17	17	13,5	18	23	0,018
14	R1/2	3109 08 21	21	13,5	19,5	23	0,032
	R1/8	3109 10 10	15	16	23	26,5	0,012
16	R1/4	3109 10 13	15	16	22	26,5	0,014
	R3/8	3109 10 17	17	16	22	26,5	0,020
18	R1/2	3109 10 21	21	16	22	26,5	0,034
	R1/4	3109 12 13	15	19	25	31	0,016
20	R3/8	3109 12 17	17	19	25	31	0,022
	R1/2	3109 12 21	21	19	25	31	0,037
22	R3/8	3109 14 17	20	22	30,5	35,5	0,031
	R1/2	3109 14 21	24	22	28,5	35,5	0,042
24	R3/8	3109 16 17	27	27	53	39	0,106
	R1/2	3109 16 21	27	27	53	39	0,104

Rosca con "pre-coating"
Racor orientable

Racores instantáneos LF 3000® / Racores de implantación



3109 Codo, rosca macho NPT

Polímero técnico, Latón niquelado, NBR

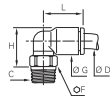

ØD	C	F	G	H	L	Kg
4	NPT1/8 3109 04 11	11	8,4	13,5	14	0,007
	NPT1/4 3109 04 14	14	8,4	14	14	0,016
6	NPT1/8 3109 06 11	11	10,5	15,5	16	0,007
	NPT1/4 3109 06 14	14	10,5	16	16	0,016
8	NPT1/8 3109 08 11	11	13,5	19	23,1	0,009
	NPT1/4 3109 08 14	14	13,5	18	23,1	0,015
10	NPT1/4 3109 10 14	15	16	23	26,5	0,017
	NPT3/8 3109 10 18	18	16	22	26,5	0,023
12	NPT1/2 3109 10 22	22	16	23	26,5	0,046
	NPT1/2 3109 12 22	22	19	26	31	0,048

Rosca con "pre-coating"
Racor orientable

3109 Codo, rosca macho NPT

Pulgadas

Polímero técnico, Latón niquelado, NBR

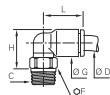

ØD	C	F	G	H	L	Kg
1/8	NPT1/8 3109 53 11	11	8,6	13,5	14,5	0,007
	NPT1/4 3109 53 14	14	8,6	14	14,5	0,015
1/4	NPT1/8 3109 56 11	11	11	17	18	0,008
	NPT1/4 3109 56 14	14	11	16	18	0,014
3/8	NPT3/8 3109 56 18	18	11	16,5	18	0,021
	NPT1/8 3109 60 11	15	16	23,1	27,4	0,014
1/2	NPT1/4 3109 60 14	15	16	23,1	27,4	0,017
	NPT3/8 3109 60 18	18	16	22,1	27,4	0,024
1/2	NPT3/8 3109 62 18	20	22,1	31	35,1	0,033
	NPT1/2 3109 62 22	24	22,1	28,4	35,1	0,045

Rosca con "pre-coating"
Racor orientable
5/32"(4 mm) y 5/16"(8 mm) también disponible

3109 Codo, rosca macho BSPT

Pulgadas

Polímero técnico, Latón niquelado, NBR

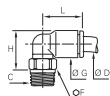

ØD	C	F	G	H	L	Kg
1/8	R1/8 3109 53 10	10	8,6	13,5	14,5	0,011
	R1/8 3109 56 10	10	11	17	18	0,006
1/4	R1/4 3109 56 13	14	11	17	18	0,013
	R1/4 3109 60 13	15	16	22,1	26,4	0,016
3/8	R3/8 3109 60 17	17	16	22,1	26,4	0,054
	R1/4 3109 62 13	20	22,1	31	35,1	0,064
1/2	R3/8 3109 62 17	20	22,1	31	35,1	0,067
	R1/2 3109 62 21	24	22,1	28,4	35,1	0,046

Rosca con "pre-coating"
Racor orientable
5/32"(4 mm) y 5/16"(8 mm) también disponible

3199 Codo, rosca macho BSPT y métrica

Polímero técnico, Latón niquelado, NBR

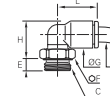

ØD	C	E	F	G	H	L	Kg
3	M3x0,5 3199 03 09*	2,5	8	8,5	15	14,5	0,003
	M5x0,8 3199 03 19	3,5	8	8,5	13,5	14,5	0,003
4	M3x0,5 3199 04 09*	2,5	8	8,5	15	14,5	0,003
	M5x0,8 3199 04 19	3,5	8	8,5	13,5	14	0,002
4	M7x1 3199 04 55	4,5	10	8,5	15	14	0,005
	G1/8 3199 04 10	5	13	8,5	13	14	0,006
4	G1/4 3199 04 13	5,5	16	8,5	13	14	0,011
	M5x0,8 3199 06 19	3,5	8	10,5	15,5	16	0,003
4	M7x1 3199 06 55	4,5	10	10,5	17,5	16	0,006
	M10x1 3199 06 60	5	13	10,5	15	14	0,006
6	M12x1,5 3199 06 67	5,5	15	10,5	15	16	0,009
	G1/8 3199 06 10	5	13	10,5	15	16	0,006
6	G1/4 3199 06 13	5,5	16	10,5	15	16	0,011
	G3/8 3199 06 17	5,5	20	10,5	15,5	16	0,022
6	G1/2 3199 06 21	7	24	10,5	16	16	0,027
	M10x1 3199 08 60	5	13	13,5	20,5	23	0,009
6	M12x1,5 3199 08 67	5,5	15	13,5	18	23	0,009
	G1/8 3199 08 10	4,5	13	13,5	20,5	23	0,009
8	G1/4 3199 08 13	5,5	16	13,5	18,5	23	0,012
	G3/8 3199 08 17	5,5	20	13,5	18,5	23	0,017
8	G1/2 3199 08 21	7	24	13,5	19	23	0,027
	G1/4 3199 10 13	5,5	16	16	23,5	26,5	0,014
10	G3/8 3199 10 17	5,5	20	16	22	26,5	0,017
	G1/2 3199 10 21	7	24	16	22	26,5	0,026
10	G1/4 3199 12 13	5,5	16	19	26,5	31	0,016
	12	G3/8 3199 12 17	5,5	20	19	25	31
12	G1/2 3199 12 21	7	24	19	25	31	0,029
	G3/8 3199 14 17	5,5	20	22	32,5	35,5	0,029
14	G1/2 3199 14 21	7	24	22	27	35,5	0,028
	16	G3/8 3199 16 17	7,5	27	27	54,5	39
16	G1/2 3199 16 21	9	27	27	54,5	39	0,097

Racor orientable

* Con junta bi-materia

Racores instantáneos LF 3000® / Racores de implantación

3192 Codo, rosca hembra BSPP

Polímero técnico, Latón niquelado, NBR

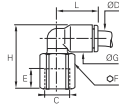

ØD	C		E	F	G	H	L	Kg
4	G1/8	3192 04 10	8,5	13	8,5	23	14	0,010
	G1/4	3192 04 13	11,5	16	8,5	27	14	0,016
6	G1/8	3192 06 10	8,5	13	10,5	25	16	0,010
	G1/4	3192 06 13	11,5	16	10,5	29	16	0,017
8	G1/8	3192 08 10	8,5	13	13,5	28	23	0,012
	G1/4	3192 08 13	11,5	16	13,5	32	23	0,020
10	G3/8	3192 08 17	12	19	13,5	33	23	0,026
	G1/4	3192 10 13	11	16	16	34,5	26,5	0,020
12	G3/8	3192 10 17	12	19	16	35	26,5	0,025
	G1/2	3192 10 21	16	24	16	41	26,5	0,048
12	G1/4	3192 12 13	11	16	19	38	30,5	0,022
	G3/8	3192 12 17	12	19	19	38,5	30,5	0,027
12	G1/2	3192 12 21	16	24	19	43,5	30,5	0,050

Racor orientable

3169 Codo elevado, rosca macho BSPP y métrica

Polímero técnico, Latón niquelado, NBR

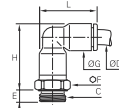

ØD	C		E	F	G	H	L	Kg
4	M5x0,8	3169 04 19	3,5	8	8,5	23	19	0,006
	G1/8	3169 04 10	5	13	8,5	22,5	19	0,008
6	G1/4	3169 04 13	5,5	16	8,5	22,5	19	0,014
	M5x0,8	3169 06 19	3,5	10	10,5	27,5	23	0,008
6	M7x1	3169 06 55	4,5	10	10,5	26	23	0,012
	G1/8	3169 06 10	5	13	10,5	27	23	0,011
8	G1/4	3169 06 13	5,5	16	10,5	27	23	0,016
	G1/8	3169 08 10	5	13	13,5	36	29,5	0,018
8	G1/4	3169 08 13	5,5	16	13,5	33	29,5	0,021
	G3/8	3169 08 17	5,5	20	13,5	33	29,5	0,028
10	G1/4	3169 10 13	5,5	16	16	40,5	34,5	0,028
	G3/8	3169 10 17	5,5	20	16	40,5	34,5	0,036
12	G1/2	3169 10 21	7	24	16	40,5	34,5	0,049
	G1/4	3169 12 13	5,5	19	19	44,5	40,5	0,044
12	G3/8	3169 12 17	5,5	20	19	42	40,5	0,038
	G1/2	3169 12 21	7	24	19	42	40,5	0,043
14	G3/8	3169 14 17	5,5	22	22	51	46,5	0,059
	G1/2	3169 14 21	7	24	22	48,5	46,5	0,063
16	G3/8	3169 16 17	7,5	27	27	82,5	52	0,220
	G1/2	3169 16 21	9	27	27	82,5	52	0,206

Racor orientable

3129 Codo elevado, rosca macho BSPT

Polímero técnico, Latón niquelado, NBR

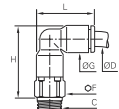

ØD	C		F	G	H	L	Kg
4	R1/8	3129 04 10	10	8,5	23	19	0,008
	R1/4	3129 04 13	14	8,5	23,5	19	0,018
6	R1/8	3129 06 10	10	10,5	27	22,5	0,010
	R1/4	3129 06 13	14	10,5	27,5	22,5	0,020
8	R1/8	3129 08 10	13	13,5	34,5	29,5	0,018
	R1/4	3129 08 13	14	13,5	32,5	29,5	0,022
10	R3/8	3129 08 17	17	13,5	33	29,5	0,032
	R1/4	3129 10 13	15	16	39,5	34,5	0,031
12	R3/8	3129 10 17	17	16	39,5	34,5	0,042
	R1/2	3129 10 21	21	16	39,5	34,5	0,058
12	R1/4	3129 12 13	19	19	45,5	40,5	0,051
	R3/8	3129 12 17	19	19	45,5	40,5	0,047
14	R1/2	3129 12 21	21	19	45,5	40,5	0,053
	R3/8	3129 14 17	21	22	51,5	46,5	0,065
14	R1/2	3129 14 21	21	22	51,5	46,5	0,071

Rosca con "pre-coating"
Racor orientable

3113 Codo 45°, rosca macho BSPT

Polímero técnico, Latón niquelado, NBR

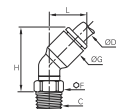

ØD	C		F	G	H	L	Kg
4	R1/8	3113 04 10	10	9	21	13	0,006
	R1/8	3113 06 10	10	11	24,5	14,5	0,006
6	R1/4	3113 06 13	14	11	25	14,5	0,015
	R1/8	3113 08 10	10	13,5	30	19,5	0,007
8	R1/4	3113 08 13	14	13,5	28,5	19,5	0,014
	R3/8	3113 08 17	17	13,5	28,5	19,5	0,018
10	R1/4	3113 10 13	15	16	33,5	23	0,014
	R3/8	3113 10 17	17	16	33,5	23	0,020
12	R1/2	3113 10 21	21	16	34	23	0,032
	R1/4	3113 12 13	15	19	39	26	0,016
12	R3/8	3113 12 17	17	19	39	26	0,022
	R1/2	3113 12 21	21	19	39	26	0,034

Rosca con "pre-coating"
Racor orientable
Este modelo permite evitar cualquier curvatura de los tubos.

Racores instantáneos LF 3000® / Racores de implantación

3133 Codo 45°, rosca macho BSPP y métrica

Polímero técnico, Latón niquelado, NBR



ØD	C		E	F	G	H	L	Kg
4	M5x0,8	3133 04 19	3,5	8	9	23	13	0,003
	G1/8	3133 04 10	4,5	13	9	20,5	13	0,006
6	M5x0,8	3133 06 19	3,5	8	11	28	14,5	0,003
	G1/8	3133 06 10	4,5	13	11	24	14,5	0,006
	G1/4	3133 06 13	5,5	16	11	24	14,5	0,011
8	G1/8	3133 08 10	4,5	13	13,5	31	19,5	0,009
	G1/4	3133 08 13	5,5	16	13,5	29	19,5	0,012
	G3/8	3133 08 17	5,5	20	13,5	29	19,5	0,017
10	G1/4	3133 10 13	5,5	16	16	35	23	0,014
	G3/8	3133 10 17	5,5	20	16	33,5	23	0,017
	G1/2	3133 10 21	7	24	16	33,5	23	0,026
12	G1/4	3133 12 13	5,5	16	19	40,5	26	0,016
	G3/8	3133 12 17	5,5	20	19	39	26	0,019
	G1/2	3133 12 21	7	24	19	39	26	0,029

Racor orientable
Este modelo permite evitar cualquier curvatura de los tubos.

3198 Te, rosca macho central BSPP y métrica

Polímero técnico, Latón niquelado, NBR

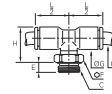

ØD	C		E	F	G	H	L/2	Kg
4	M5x0,8	3198 04 19	3,5	8	8,5	17,5	14	0,003
	G1/8	3198 04 10	5	13	8,5	15	14	0,006
6	G1/4	3198 04 13	5,5	16	8,5	15	14	0,011
	M5x0,8	3198 06 19	3,5	8	10,5	19,5	16	0,004
8	G1/8	3198 06 10	5	13	10,5	17	16	0,007
	G1/4	3198 06 13	5,5	16	10,5	17	16	0,012
10	G1/8	3198 08 10	4,5	13	13,5	23,5	23	0,011
	G1/4	3198 08 13	5,5	16	13,5	21,5	23	0,014
	G3/8	3198 08 17	5,5	20	13,5	21,5	23	0,019
12	G1/4	3198 10 13	5,5	16	16	26	26,5	0,017
	G3/8	3198 10 17	5,5	20	16	24	26,5	0,020
	G1/2	3198 10 21	7	24	16	24	26,5	0,029
14	G1/4	3198 12 13	5,5	16	19	29	31	0,021
	G3/8	3198 12 17	5,5	20	19	27	31	0,024
	G1/2	3198 12 21	7	24	19	27	31	0,033
16	G3/8	3198 14 17	5,5	20	22	32,5	35,5	0,036
	G1/2	3198 14 21	7	24	22	27	35,5	0,036
	G3/8	3198 16 17	7,5	27	27	54,5	38,5	0,121
	G1/2	3198 16 21	9	27	27	54,5	38,5	0,117

Racor orientable

3108 Te, rosca macho central BSPT

Polímero técnico, Latón niquelado, NBR

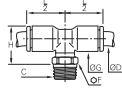

ØD	C		F	G	H	L/2	Kg
4	R1/8	3108 04 10	10	8,5	15,5	14	0,006
	R1/4	3108 04 13	14	8,5	16	14	0,015
6	R1/8	3108 06 10	10	10,5	17,5	16	0,007
	R1/4	3108 06 13	14	10,5	18	16	0,016
8	R1/8	3108 08 10	10	13,5	22	23	0,009
	R1/4	3108 08 13	14	13,5	21	23	0,016
	R3/8	3108 08 17	17	13,5	21	23	0,020
10	R1/4	3108 10 13	15	16	24	26,5	0,017
	R3/8	3108 10 17	17	16	24	26,5	0,022
	R1/2	3108 10 21	21	16	24	26,5	0,034
12	R1/4	3108 12 13	15	19	27	31	0,021
	R3/8	3108 12 17	17	19	27	31	0,027
	R1/2	3108 12 21	21	19	27	31	0,041
14	R3/8	3108 14 17	20	22	30,5	35	0,038
	R1/2	3108 14 21	24	22	28,5	35	0,049
16	R3/8	3108 16 17	27	27	53	38,5	0,128
	R1/2	3108 16 21	27	27	53	38,5	0,124

Rosca con "pre-coating"
Racor orientable

3103 Te, rosca macho lateral BSPT

Polímero técnico, Latón niquelado, NBR



ØD	C		F	G	H	H1	L	Kg
4	R1/8	3103 04 10	10	8,5	23,5	9	14,5	0,006
	R1/4	3103 04 13	14	8,5	24	9,5	14,5	0,015
6	R1/8	3103 06 10	10	10,5	27,5	10	17,5	0,007
	R1/4	3103 06 13	14	10,5	28	10,5	17,5	0,016
8	R1/8	3103 08 10	10	13,5	35	12	23	0,009
	R1/4	3103 08 13	14	13,5	34	11	23	0,015
	R3/8	3103 08 17	17	13,5	34	11	23	0,020
10	R1/4	3103 10 13	15	16	40,5	14	26,5	0,017
	R3/8	3103 10 17	17	16	40,5	14	26,5	0,022
	R1/2	3103 10 21	21	16	40,5	14	26,5	0,035
12	R1/4	3103 12 13	15	19	46,5	15,5	31	0,021
	R3/8	3103 12 17	17	19	46,5	15,5	31	0,026
	R1/2	3103 12 21	21	19	46,5	15,5	31	0,041
14	R1/2	3103 14 21	24	22	52,5	17,5	35,5	0,049
	R3/8	3103 16 17	27	27	78	27	38,5	0,126
	R1/2	3103 16 21	27	27	78	27	38,5	0,124

Rosca con "pre-coating"
Racor orientable

Racores instantáneos LF 3000® / Racores de implantación

3193 Te, rosca macho lateral BSPP y métrica

Polímero técnico, Latón niquelado, NBR

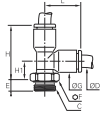

ØD	C		E	F	G	H	H1	L	Kg
4	M5x0,8	3193 04 19	3,5	8	8,5	26	11,5	14,5	0,003
	G1/8	3193 04 10	5	13	8,5	23	8,5	14,5	0,006
6	G1/4	3193 04 13	5,5	16	8,5	23	8,5	14,5	0,011
	M5x0,8	3193 06 19	3,5	8	10,5	29,5	12,5	17,5	0,004
8	G1/8	3193 06 10	5	13	10,5	27	10	17,5	0,007
	G1/4	3193 06 13	5,5	16	10,5	27	10	17,5	0,012
10	G1/8	3193 08 10	4,5	13	13,5	36,5	14	23	0,011
	G1/4	3193 08 13	5,5	16	13,5	34,5	12	23	0,014
12	G3/8	3193 08 17	5,5	20	13,5	34,5	12	23	0,019
	G1/4	3193 10 13	5,5	16	16	42	15,5	26,5	0,017
14	G3/8	3193 10 17	5,5	20	16	40,5	14	26,5	0,020
	G1/2	3193 10 21	7	24	16	40,5	14	26,5	0,029
16	G1/4	3193 12 13	5,5	16	19	48	17	31	0,021
	G3/8	3193 12 17	5,5	20	19	46,5	15,5	31	0,024
18	G1/2	3193 12 21	7	24	19	46,5	15,5	31	0,033
	G3/8	3193 14 17	5,5	20	22	56,5	21,5	35,5	0,036
20	G1/2	3193 14 21	7	24	22	51	16	35,5	0,036
	G3/8	3193 16 17	7,5	27	27	79,5	41	38,5	0,121
22	G1/2	3193 16 21	9	27	27	79,5	41	38,5	0,117

Racor orientable

3158 Y simple, rosca macho BSPP y métrica

Polímero técnico, Latón niquelado, NBR

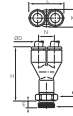

ØD	C		E	F	H	K	L	N	Kg
4	M5x0,8	3158 04 19	3,5	8	32,5	8,5	17,5	9	0,006
	M5x0,8	3158 06 19	3,5	10	39,5	10,5	21,5	11	0,009
6	G1/8	3158 06 10	5	13	39	10,5	21,5	11	0,012
	G1/4	3158 06 13	5,5	16	39,5	10,5	21,5	11	0,017
8	G1/8	3158 08 10	5	13	49	13,5	28	14,5	0,020
	G1/4	3158 08 13	5,5	16	49,5	13,5	28	14,5	0,023
10	G3/8	3158 08 17	6	19	48	13,5	28	14,5	0,031
	G1/4	3158 10 13	5,5	16	58	16	33	17	0,032
12	G3/8	3158 10 17	6	20	57,5	16	33	17	0,040
	G1/2	3158 10 21	7	24	58	16	33	17	0,054
14	G3/8	3158 12 17	6	20	62	19	39	20	0,044
	G1/2	3158 12 21	7	24	63	19	39	20	0,050

Racor orientable

3132 Y doble, rosca macho BSPP

Polímero técnico, Latón niquelado, NBR

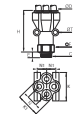

ØD	C		E	F	H	K	K1	N	N1	ØT	Kg
4	G1/8	3132 04 10	5	13	41	25,5	21	10	8,5	3,7	0,022
	G1/4	3132 04 13	5,5	16	40	25,5	21	10	8,5	3,7	0,026
6	G1/8	3132 06 10	5	19	53,5	31,5	26,5	12	10	3,7	0,041
	G1/4	3132 06 13	5,5	19	52,5	31,5	26,5	12	10	3,7	0,042

Racor orientable

3148 Y simple, rosca macho BSPT

Polímero técnico, Latón niquelado, NBR

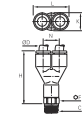

ØD	C		F	H	K	L	N	Kg
4	R1/8	3148 04 10	10	32,5	8,5	17,5	9	0,009
	R1/4	3148 04 13	14	33	8,5	17,5	9	0,018
6	R1/8	3148 06 10	10	39,5	10,5	21,5	11	0,012
	R1/4	3148 06 13	14	40	10,5	21,5	11	0,021
8	R1/8	3148 08 10	13	56,5	13,5	28	14,5	0,020
	R1/4	3148 08 13	14	55,5	13,5	28	14,5	0,025
10	R3/8	3148 08 17	16	48,5	13,5	28	14,5	0,034
	R1/4	3148 10 13	14	60	19	39	20	0,033
12	R3/8	3148 10 17	16	60,5	19	39	20	0,043
	R1/2	3148 10 21	24	61	19	39	20	0,062
14	R3/8	3148 12 17	19	66	19	39	20	0,054
	R1/2	3148 12 21	21	66	19	39	20	0,059

Rosca con "pre-coating"
Racor orientable

Racores instantáneos LF 3000® / Racores de implantación

3100 Cartucho monobloque Carstick®

Latón, NBR



ØD		G	G1	H	L	Kg
4	3100 04 00	8	11	10	554	0,007
6	3100 06 00	10	14,5	11,5	629	0,002
8	3100 08 00	13	15	15	794	0,002
10	3100 10 00	15,5	19,5	17	930	0,005
12	3100 12 00	19,5	21	19,5	1038	0,010
14	3100 14 00	21	24,5	22,5	1110	0,013

50 cartuchos por caja de Carstick®
Tamaño de las ranuras disponibles a petición.

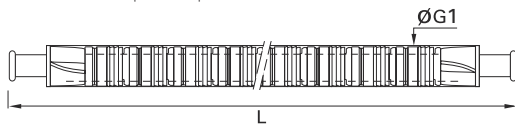

3100 Cartucho monobloque Carstick® Pulgadas

Latón niquelado, NBR



ØD		G	G1	H	L	Kg
1/8	3100 53 00 99	7	10	9	508	0,002
5/32	3100 04 00 99	8	11	10	554	0,007
1/4	3100 56 00 99	10,5	14,5	12	600	0,003
5/16	3100 08 00 99	13	15	15	794	0,002
3/8	3100 60 00 99	15,5	19	16,5	930	0,006

50 cartuchos por caja de Carstick®
(4 mm) y 5/16" (8 mm) también disponibles
Tamaño de la ranura disponible a pedido

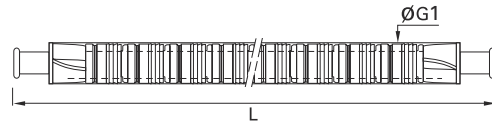

Dimensiones de los alojamientos

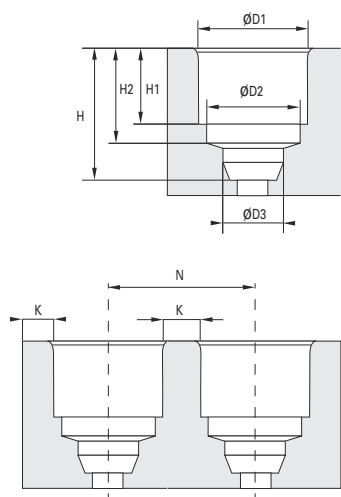

Carstick® Métrico

Cavidad	ØD3	H	H1	H2
4	4,1	10	6	8,15
6	6,1	12	7,5	9,65
8	8,15	15,5	9,9	12,45
10	10,25	19	11,7	14,35
12	12,17	22	13,9	16,75

Carstick® Pulgadas

Cavidad	ØD3	H	H1	H2
1/8	3,25	9,5	5,3	7,45
5/32*	4,1	10	6	8,15
1/4	6,45	12,5	8	10,15
5/16*	8,15	15,5	9,9	12,45
3/8	9,65	19	11,7	14,35

Alojamiento de poliamida

Cavidad	ØD1	ØD2	N	K
4	8,25	7,05	9,8	1,5
6	10,2	9,15	12,2	2
8	12,15	10,85	14,2	2
10	14,8	13,2	16,8	2
12	17,5	15,5	20	2,5

Cavidad	ØD1	ØD2	N	K
1/8	7,05	6,02	8,6	1,5
5/32*	8,25	7,05	9,75	1,5
1/4	10,55	9,35	12,6	2
5/16*	12,15	10,85	14,2	2
3/8	14,8	13,1	16,8	2

Alojamiento de aluminio

Cavidad	ØD1	ØD2	N	K
4	8,25	7,5	11,5	3
6	10,3	9,15	13,5	3
8	12,2	10,85	15,2	3
10	15,05	13,2	17,1	2
12	17,5	15,5	20	2,5

Cavidad	ØD1	ØD2	N	K
1/8	7,1	6,2	8,6	1,5
5/32*	8,25	7,05	11,25	3
1/4	10,6	9,35	12,65	2
5/16*	12,2	10,85	15,2	3
3/8	15,05	13,1	17,1	2

Alojamiento de latón

Cavidad	ØD1	ØD2	N	K
4	8,25	7,05	10,25	2
6	10,25	9,1	12,25	2
8	12,2	10,85	14,25	2
10	15,05	13,2	17,1	2
12	17,65	15,5	20	2,5

Cavidad	ØD1	ØD2	N	K
1/8	7,1	6,2	8,6	1,5
5/32*	8,25	7,05	10,25	2
1/4	10,6	9,35	12,65	2
5/16*	12,2	10,85	14,25	2
3/8	15,05	13,1	17,1	2

*5/32" = 4 mm y 5/16" = 8 mm

Rogamos consulten con nosotros para obtener el plano detallado necesario para la realización de los alojamientos, así como sus materiales.
A título indicativo, todas nuestras dimensiones están en milímetros.

Racores instantáneos LF 3000® / Racores de unión

3106 Unión doble igual y desigual

Polímero técnico, NBR

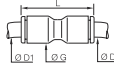

ØD	ØD1		G	L	Kg
3	3	3106 03 00	8,5	25	0,002
	4	3106 03 04	8,5	25	0,002
4	14	3106 04 56	11	29,5	0,005
	4	3106 04 00	8,5	25	0,001
6	6	3106 04 06	11	28	0,002
	8	3106 04 08	13,5	38	0,005
8	14	3106 06 56	13,5	36	0,009
	6	3106 06 00	10,5	28,5	0,002
10	8	3106 06 08	13,5	38	0,005
	10	3106 06 10	16	42	0,008
12	8	3106 08 00	13,5	38	0,004
	10	3106 08 10	16	42	0,007
14	12	3106 08 12	19	50,5	0,026
	10	3106 10 00	16	42	0,005
16	12	3106 10 12	19	50,5	0,018
	12	3106 12 62	22	56,5	0,041
18	12	3106 12 00	19	50,5	0,009
	14	3106 12 14	22	56	0,025
20	16	3106 12 16	27	61	0,066
	14	3106 14 00	22	56	0,014
22	16	3106 16 00	27	60,5	0,041

3106 Unión doble igual y desigual

Pulgadas

Polímero técnico, NBR

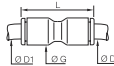

ØD	ØD1		G	L	Kg
1/4	14	3106 56 00	11	29,5	0,002
	38	3106 60 00	16	42	0,006
3/8	10	3106 60 10	12	50,5	0,028
	14	3106 60 56	16	41	0,016
1/2	12	3106 62 00	22	55	0,016

5/32"(4mm) y 5/16"(8 mm) también disponible

3102 Codo igual y desigual

Polímero técnico, NBR

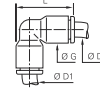

ØD	ØD1		G	L	Kg
4	4	3102 04 00	8,5	19	0,001
	6	3102 04 06	10,5	22,5	0,003
6	6	3102 06 00	10,5	22,5	0,002
	8	3102 06 08	13,5	29,5	0,008
8	8	3102 08 00	13,5	29,5	0,004
	10	3102 08 10	16	34,5	0,011
10	10	3102 10 00	16	34,5	0,006
	12	3102 10 12	19	40,5	0,019
12	12	3102 12 00	19	40,5	0,010
	14	3102 14 00	22	46,5	0,015
16	16	3102 16 00	27	52	0,043

3102 Codo igual y desigual

Pulgadas

Polímero técnico, NBR

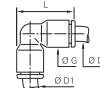

ØD	ØD1		G	L	Kg
1/4	14	3102 56 00	11	2,5	0,002
3/8	38	3102 60 00	16	34	0,006
1/2	12	3102 62 00	22	35	0,017

5/32"(4mm) y 5/16"(8 mm) también disponible

Racores instantáneos LF 3000® / Racores de unión

3104 Te igual y desigual

Polímero técnico, NBR

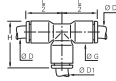

ØD	ØD1		G	H	L/2	Kg
3	3	3104 03 00	8,5	19	14,5	0,004
4	4	3104 04 00	8,5	19	14,5	0,002
4	6	3104 04 06	10,5	22,5	17,5	0,007
	4	3104 06 04	10,5	22,5	17,5	0,005
6	6	3104 06 00	10,5	22,5	17,5	0,003
	8	3104 06 08	13,5	29,5	23	0,015
8	4	3104 08 04	13,5	29	17,5	0,013
	6	3104 08 06	13,5	29,5	23	0,010
	8	3104 08 00	13,5	29,5	23	0,006
10	10	3104 08 10	16	34,5	26,5	0,020
	4	3104 10 04	16	33	26	0,023
	8	3104 10 08	16	34,5	26,5	0,014
10	10	3104 10 00	16	34,5	26,5	0,009
	12	3104 10 12	19	40,5	31	0,033
12	4	3104 12 04	19	39	31	0,040
	10	3104 12 10	19	40,5	31	0,023
12	12	3104 12 00	19	40,5	31	0,014
	8	3104 14 08	22	46	35,5	0,054
14	14	3104 14 00	22	46	35,5	0,022
16	12	3104 16 12	27	52,5	39	0,088
	16	3104 16 00	27	52	39	0,063

3104 Te igual y desigual

Pulgadas

Polímero técnico, NBR

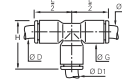

ØD	ØD1		G	H	L/2	Kg	
5/32	1/4	3104 04 56		11	23,5	18	0,008
1/8	1/8	3104 53 00		8,4	19	14,5	0,003
	1/4	3104 53 56		11	23,5	18	0,011
3/16	3/16	3104 55 00		11	27,2	21,6	0,016
	5/32	3104 56 04		11	23,5	18,5	0,014
1/4	1/4	3104 56 00		11	23	24	0,003
	1/8	3104 56 53		11	23,5	18,5	0,007
	3/8	3104 56 60		16	33,5	24,5	0,017
3/8	1/4	3104 60 56		16	32,5	25,5	0,019
	3/8	3104 60 00		16	34	26	0,009
1/2	1/2	3104 62 00		22	46	35	0,026
	1/4	3104 62 56		22,1	45,2	35,3	0,059
	3/8	3104 62 60		22	46	35	0,047

5/32"(4mm) y 5/16"(8 mm) también disponible

3140 Y simple igual y desigual

Polímero técnico, NBR

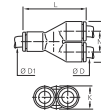

ØD	ØD1		H	K	L	N	Kg
4	4	3140 04 00	17,5	8,5	28,5	9	0,002
	6	3140 04 06	17,5	10,5	33	9	0,002
6	6	3140 06 00	21,5	10,5	35	11	0,004
	8	3140 06 08	22,5	13,5	41	11,5	0,005
8	8	3140 08 00	28	13,5	45	14,5	0,006
	10	3140 08 10	28	16	47	14,5	0,008
10	10	3140 10 00	33	16	53	17	0,010
	12	3140 10 12	33	19	57	17	0,012
12	12	3140 12 00	39	19	57	20	0,017

3107 Cruz igual y desigual

Polímero técnico, NBR

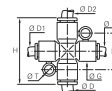

ØD	ØD1	ØD2		G	H	N	ØT	Kg
4	4	4	3107 04 00	11	36	20	4,2	0,014
6	4	6	3107 04 06	11	36	20	4,2	0,009
4	4	6	3107 06 04	11	36	20	4,2	0,011
6	6	6	3107 06 00	11	36	20	4,2	0,005
8	6	8	3107 06 08	11	46	22,5	4,2	0,018
6	6	8	3107 08 06	13,5	46	22,5	4,2	0,022
8	8	8	3107 08 00	13,5	46	22,5	4,2	0,009

Racores instantáneos LF 3000® / Racores pasatabiques

3116 Unión igual pasatabiques

Polímero técnico, NBR

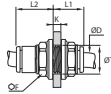

ØD		F	K max	L1	L2	ØT min	Kg
4	3116 04 00	13	5,5	15	10	10,5	0,003
6	3116 06 00	15	8	19	11,5	12,5	0,004
8	3116 08 00	18	14,5	25	13,5	15,5	0,007
10	3116 10 00	22	14,5	27,5	15,5	18,5	0,011
12	3116 12 00	26	18,5	33	18	22,5	0,019
14	3116 14 00	29	20,5	37,5	20,5	25,5	0,028

3136 Unión pasatabiques, rosca hembra BSPP

Latón niquelado, NBR

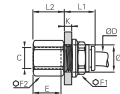

ØD	C		E	F1	F2	K max	L1	L2	ØT min	Kg
4	G1/8	3136 04 10	9,5	13	13	7	17	11,5	10,5	0,015
	G1/4	3136 04 13	13,5	13	16	7	17	15,5	10,5	0,021
6	G1/8	3136 06 10	9,5	15	15	8	19	10,5	12,5	0,021
	G1/4	3136 06 13	13,5	15	17	7	19	15,5	12,5	0,027
8	G3/8	3136 06 17	12	15	22	8	19	16	12,5	0,041
	G1/8	3136 08 10	9,5	18	17	8	20,5	10,5	15,5	0,029
10	G1/4	3136 08 13	13,5	18	17	8	20,5	14,5	15,5	0,029
	G3/8	3136 10 17	14	22	22	8,5	23	16	18,5	0,050
12	G3/8	3136 12 17	14	26	24	8,5	27	16	22,5	0,079
	G1/2	3136 12 21	19,5	26	27	8,5	27	21,5	22,5	0,098
16	G3/8	3136 16 17	12	29	29	10,5	30	15	27,5	0,125
	G1/2	3136 16 21	15	29	29	10,5	30	19,5	27,5	0,126

3146 Unión mixta pasatabiques igual

Latón niquelado, NBR

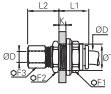

ØD		F1	F2	F3	K max	L1	L2	ØT min	Kg
4	3146 04 00	13	13	10	7	17,5	17,5	10,5	0,018
6	3146 06 00	15	17	13	8	19	18	12,5	0,028
8	3146 08 00	18	19	14	8	20,5	20,5	15,5	0,036
10	3146 10 00	22	22	19	8,5	23	24,5	18,5	0,062
12	3146 12 00	26	25	22	8,5	27	25	22,5	0,095
14	3146 14 00	29	29	24	10,5	27	27	25,5	0,124

Conexión instantánea y conexión universal

3139 Codo igual pasatabiques

Polímero técnico, Latón niquelado, NBR

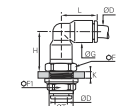

ØD		F	F1	G	H	K max	L	ØT min	Kg
4	3139 04 00	13	13	8,5	17	6,5	14,5	10,5	0,014
6	3139 06 00	17	15	10,5	19,5	7	17,5	12,5	0,021
8	3139 08 00	19	18	13,5	24	8	23	15,5	0,032
10	3139 10 00	22	22	16	28	8,5	26	18,5	0,048
12	3139 12 00	24	26	19	33	8,5	31	22,5	0,084
14	3139 14 00	27	29	25,5	37,5	10,5	36	25,5	0,117

Racor orientable

Las cajas de embalaje Parker Legris aseguran una perfecta protección de los productos.

Están diseñadas para responder a las exigencias de nuestros clientes ofreciendo:

- una identificación inmediata del modelo: referencia y dibujo técnico correspondientes,
- un código de barras,
- un almacenamiento sencillo,
- un sistema de apertura/cierre fiable,
- un material reciclable.



Racores instantáneos LF 3000® / Racores de conexión múltiple



3144 Y doble igual y desigual

Polímero técnico, NBR

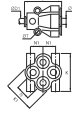

ØD	ØD1		K	K1	L	N	N1	ØT	Kg
4	4	3144 04 04	25,5	21	30,5	10	8,5	3,7	0,015
	6	3144 04 06	25,5	21	30,5	10	8,5	3,7	0,013
6	6	3144 06 06	31,5	26,5	37,5	12	10	3,7	0,032
	8	3144 06 08	31,5	26,5	38	12	10	3,7	0,026

3306 Multi-codo desigual a 90°

Polímero técnico, NBR

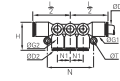

ØD1	ØD2		G	G1	H	L/2	N	N1	ØT	Kg
6	4	3306 06 04	13,5	11	18,5	36	43	11,5	4,2	0,034
	8	3306 08 04	13,5	11	18,5	36,5	43	11,5	4,2	0,025
8	6	3306 08 06	13,5	11	18,5	36,5	43	11,5	4,2	0,022
	10	3306 10 06	16	13,5	23	42	52	14,5	4,2	0,048
10	8	3306 10 08	16	13,5	23,5	42	52	14,5	4,2	0,021

3304 Multi-te de alimentación

Polímero técnico, NBR

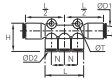

ØD1	ØD2		H	L	L/2	N	ØT	Kg
6	4	3304 06 04	24,5	34	37	11,5	4,2	0,015
	8	3304 08 04	24,5	34	37	11,5	4,2	0,012
8	6	3304 08 06	24,5	34	37	11,5	4,2	0,010
	10	3304 10 06	36	44	40,5	14,5	4,2	0,019
10	8	3304 10 08	36	44	40,5	15,5	4,2	0,015

3310 Regleta de distribución en línea

Aluminio tratado, NBR

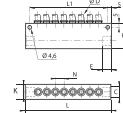

ØD	C		Número de salida	E	H	K	L	L1	N	Kg
4	G1/4	3310 04 13	8	10	33	20	114	104	11,5	0,164
6	G1/4	3310 06 13	8	10	33	20	114	104	12,5	0,160
8	G3/8	3310 08 17	6	12	33	20	114	104	15	0,149
10	G1/2	3310 10 21	6	16	48	25	145,5	135,5	17	0,329
12	G1/2	3310 12 21	4	16	45	25	158	148	20,5	0,354

01 // Racores

Racores instantáneos

LF 3000®

Parker Legris ofrece el modelo adecuado para cada configuración de instalación.



Racores instantáneos LF 3000® / Racores y accesorios enclavables

3182 Codo igual y desigual enclavable

Polímero técnico, NBR

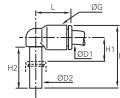

ØD1	ØD2		G	H	H1	H2	L	Kg
4	4	3182 04 00	8,5	23	6	15,5	14	0,005
4	6	3182 04 06	10,5	26,5	7	17	16	0,004
	4	3182 06 04	10,5	24,5	7	15,5	16	0,001
6	6	3182 06 00	10,5	26,5	7	17	16	0,001
	8	3182 06 08	13,5	33,5	8	21,5	23	0,007
8	8	3182 08 00	13,5	33,5	8	21,5	23	0,003
	10	3182 08 10	16	39	10	24,5	26,5	0,010
	10	3182 10 00	16	39	10	24,5	26,5	0,004
10	12	3182 10 12	19	44,5	10,5	27,5	31	0,016
12	12	3182 12 00	19	45,5	10,5	27,5	31	0,007

Las referencias en diámetro de 4 mm y 12 mm no son ranuradas en la versión estándar.

3180 Codo 45° igual enclavable

Polímero técnico, NBR

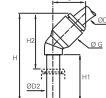

ØD1	ØD2		G	H	H1	H2	L	Kg	
4	4	3180 04 00		9	33,5	19	21	13	0,001
6	6	3180 06 00		11	39	21	25	14,5	0,002
8	8	3180 08 00		13,5	44	21,5	25,5	19,5	0,003
10	10	3180 10 00		16	53	27	32,5	23	0,004
12	12	3180 12 00		19	58,5	27,5	34	26,5	0,007

3182 Codo igual enclavable

Pulgadas

Polímero técnico, NBR

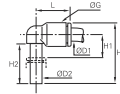

ØD1	ØD2		G	H	H1	H2	L	Kg
14	1/4	3182 56 00	11	27,5	7,5	18	18,5	0,002
38	3/8	3182 60 00	16	38,5	9	24	26	0,010

5/32"(4mm) y 5/16"(8 mm) también disponible

3183 Te igual y desigual enclavable con espiga lisa

Polímero técnico, NBR

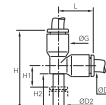

ØD1	ØD2		G	H	H1	H2	L	Kg
4	4	3183 04 00	8,5	33	6	15,5	14,5	0,002
	6	3183 04 06	10,5	38,5	7	17	17,5	0,006
6	6	3183 06 00	10,5	38,5	7	17	17	0,002
	8	3183 06 08	13,5	48,5	8	21,5	23	0,014
8	8	3183 08 00	13,5	49	8	21,5	23	0,004
	10	3183 08 10	16	56,5	10,5	24,5	26,5	0,018
	10	3183 10 00	16	57	10,5	24,5	26,5	0,007
10	12	3183 10 12	19	65,5	10,5	27,5	31	0,034
12	12	3183 12 00	19	65,5	10,5	27,5	31	0,011

3184 Codo prolongado igual y desigual enclavable

Polímero técnico, NBR

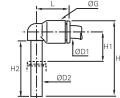

ØD1	ØD2		G	H	H1	H2	L	Kg
4	4	3184 04 00	8,5	32,5	15,5	25	14	0,004
	6	3184 04 06	10,5	38,5	19	29	16	0,004
6	6	3184 06 00	10,5	38,5	19	29	16	0,002
	8	3184 06 08	13,5	49	23,5	37	23	0,007
8	8	3184 08 00	13,5	49	23,5	37	23	0,003
	10	3184 08 10	16	56	26,5	41,5	26,5	0,011
	10	3184 10 00	16	56	26,5	41,5	26,5	0,005
10	12	3184 10 12	19	62,5	28	45,5	31	0,017
12	12	3184 12 00	19	62,5	28	45,5	31	0,008

Las referencias en diámetro de 4 mm y 12 mm no son ranuradas en la versión estándar.

3188 Te igual y desigual enclavable con espiga lisa

Polímero técnico, NBR

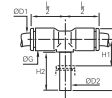

ØD1	ØD2		G	H	H1	H2	L/2	Kg
4	4	3188 04 00	8,5	25	8	15,5	14,5	0,001
	6	3188 04 06	10,5	28,5	9	17	16	0,007
6	6	3188 06 00	10,5	28,5	9	17	16	0,002
	8	3188 06 08	13,5	36,5	11	21,5	22	0,014
8	8	3188 08 00	13,5	36,5	11	21,5	23	0,004
	10	3188 08 10	16	41	12,5	24,5	26,5	0,018
	10	3188 10 00	16	41	12,5	24,5	26,5	0,007
10	12	3188 10 12	19	46,5	12,5	27,5	31	0,030
12	12	3188 12 00	19	46,5	12,5	27,5	31	0,012

Racores instantáneos LF 3000® / Racores y accesorios enclavables



3142 Y simple igual y desigual enclavable

Polímero técnico, NBR

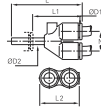

ØD1	ØD2		L	L1	L2	N	Kg
4	4	3142 04 00	34	21,5	17,5	9	0,002
	6	3142 04 06	35,5	21,5	17,5	9	0,004
6	6	3142 06 00	39,5	25,5	21,5	11	0,004
	8	3142 06 08	44,5	26	22	11	0,006
8	8	3142 08 00	50,5	32	28	14,5	0,007
	10	3142 08 10	53,5	32	28	14,5	0,022
10	10	3142 10 00	57,5	36	33	17	0,010
	12	3142 10 12	60	35	33	17	0,035
12	12	3142 12 00	66	41	39	20	0,017

3166 Reductor enclavable

Polímero técnico, NBR

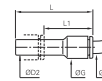

ØD1	ØD2		G	L	L1	Kg
3	4	3166 03 04	8,5	37,5	23,5	0,002
	6	3166 04 06	8,5	37,5	23,5	0,001
4	8	3166 04 08	8,5	37,5	19	0,001
	10	3166 04 10	10,5	38	18	0,003
6	8	3166 06 08	10,5	37,5	20	0,001
	10	3166 06 10	10,5	38	17,5	0,002
8	12	3166 06 12	14,5	46	23	0,005
	14	3166 06 14	14,5	48	23	0,007
10	10	3166 08 10	13,5	49	28,5	0,003
	12	3166 08 12	13,5	49	24,5	0,004
12	14	3166 08 14	17	48	23	0,007
	12	3166 10 12	21,5	56,5	33,5	0,005
14	14	3166 10 14	21,5	58,5	33,5	0,005
	12	3166 12 14	23,5	58,5	33,5	0,007

3143 Y doble desigual enclavable

Polímero técnico, Latón niquelado, NBR

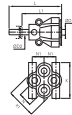

ØD1	ØD2		K	K1	L	L1	N	N1	Kg
4	6	3143 04 06	26	21,5	49,5	35,5	11	8,5	0,018
	8	3143 04 08	26	21,5	51	32	11	8,5	0,021
6	8	3143 06 08	31,5	26,5	57,5	39	12	10	0,035

3166 Reductor enclavable

Pulgadas

Polímero técnico, NBR

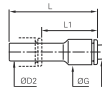

ØD1	ØD2		G	L	L1	Kg
14	5/16	3166 56 08	11	41	23	0,002
	3/8	3166 56 60	11	41	21	0,002

3120 Unión doble enclavable

Polímero técnico

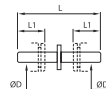

ØD		L	L1	Kg
4	3120 04 00	34,5	12	0,001
6	3120 06 00	38,5	14	0,001
8	3120 08 00	41	18,5	0,001
10	3120 10 00	51,5	20,5	0,002
12	3120 12 00	60	24,5	0,004
14	3120 14 00	69,5	25,5	0,007

3168 Ampliador enclavable

Polímero técnico, NBR

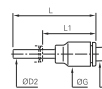

ØD1	ØD2		G	L	L1	Kg
6	4	3168 06 04	10,5	35	23	0,002
	6	3168 08 06	13,5	45	31,5	0,003
8	1/4	3168 08 56	16	40	25,5	0,009
	8	3168 10 08	16	42,5	21	0,004
12	10	3168 12 10	19	49	24,5	0,006

Este modelo se comercializa en latón niquelado : poner el sufi jo 85 en la referencia.
Ej : 3120 06 00 85.
Compatible sólo con los racores Parker Legris.
Planos disponibles bajo demanda.

01 // Racores

Racores instantáneos

LF 3000®

Racores instantáneos LF 3000® / Racores y accesorios enclavables

3168 Ampliador enclavable

Pulgadas

Polímero técnico, NBR

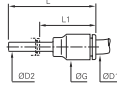

ØD1	ØD2		G	L	L1	Kg
14	3/16	3168 56 55	20,5	41	25	0,002
	5/32	3168 56 04	11	41	29	0,002

3126 Tapón enclavable

Polímero técnico

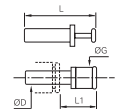

ØD		G	L	L1	Kg
3	3126 03 00	6	25	13,5	0,001
4	3126 04 00	4	30	15,5	0,001
6	3126 06 00	8	33	16,5	0,001
8	3126 08 00	10	35	17,5	0,001
10	3126 10 00	12	42	21	0,002
12	3126 12 00	14	45	22	0,003
14	3126 14 00	16	49	23,5	0,005
16	3126 16 00*	19	57	30	0,064

* Latón niquelado

3126 Tapón enclavable

Pulgadas

Polímero técnico

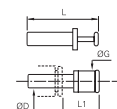

ØD		G	L	L1	Kg
1/4	3126 56 00	8	36,5	22	0,001
3/8	3126 60 00	12	42	22	0,002
1/2	3126 62 00	15	48,5	21,5	0,003

5/32"(4mm) y 5/16"(8 mm) también disponible

3122 Espiga acanalada enclavable

Polímero técnico

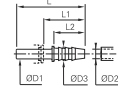

ØD1	ØD2	ØD3		L	L1	L2	Kg
4	3,2	5	3122 04 53	37	25	17	0,004
	5	7	3122 04 05	37	25	17	0,001
6	5	7	3122 06 05	39	25	17	0,001
8	6,3	8,5	3122 08 56	39,5	21	17	0,001
	8	10	3122 08 08	44,5	26	22	0,001
10	6,3	8	3122 10 56	45	24,5	17	0,002
	8	10	3122 10 08	50	29,5	22	0,002
12	8	10	3122 12 08	50	26	22	0,002
	10	12	3122 12 10	48,5	25,5	22,5	0,002
14	12,5	14,5	3122 12 62	57	34	22,5	0,004
	12,5	14,5	3122 14 62	59,5	34,5	22,5	0,006

3151 Tapón de conexión instantánea fin de línea

Polímero técnico, NBR

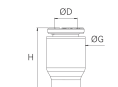

ØD		G	H	Kg
4	3151 04 00	8,5	15	0,001
6	3151 06 00	10,5	17	0,001
8	3151 08 00	13,5	22	0,002
10	3151 10 00	16	22	0,003
12	3151 12 00	19	28	0,005
14	3151 14 00	22	31	0,009

Racores instantáneos LF 3000® / Racores banjos



Una gama de accesorios técnicos de polímero para cubrir la mayoría de las necesidades de las aplicaciones neumáticas de baja presión.

Ø métrico:
4 a 12 mm

Características técnicas

- **Fluidos adecuados:** Aire comprimido
Otros fluidos: consúltenos
- **Presión de trabajo:** De vacío hasta 20 bar
- **Temperatura de trabajo:** -20°C a +80°C

Par de apriete
(daN.m)

M3 x0,5	M5 x0,8	G1/8	G1/4	G3/8	G1/2
0,05	0,1	0,4	0,5	0,6	0,7

Las prestaciones dependen de los fluidos, del material y del tubo utilizados.
El uso está garantizado para un vacío de 755 mm Hg (99% de vacío).

Ventajas

- Robusto, ligero y compacto para construir sus circuitos neumáticos
- Conexiones de caudal total para optimizar los caudales
- Uso en vacío y en aire comprimido
- Desarrollo de productos adaptados, según sus especificaciones. Contáctanos.

Materiales

Sin silicona

Tornillo: latón con o sin pre-revestimiento según los modelos

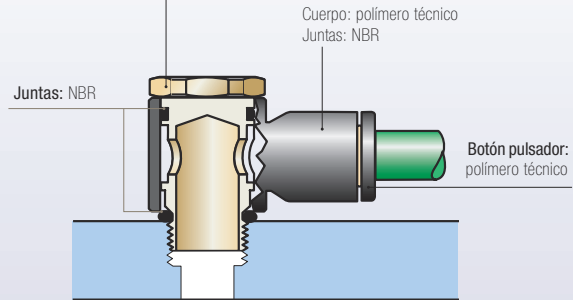

Reglamentaciones

- ISO 14743
- PED
- RoHS
- REACH

Configuraciones de instalación

Paso del tornillo en función de su rosca, para las referencias 3524 - 3527 - 3528 - 3529:

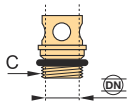

Rosca (C)	M5x0,8	G1/8	G1/4	G3/8	G1/2
(DN)	2,5	5,5	8,5	11	13

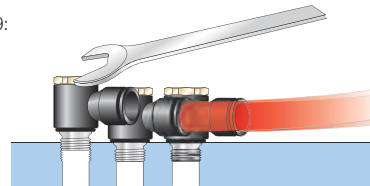

3118 Banjo codo, rosca macho BSPP y métrica

Polímero técnico, Latón niquelado, NBR

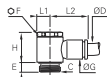

ØD	C	E	F	G	H	L1	L2	Kg
3	M3x0,5 3118 03 09*	3	-	8,5	13	5	16	0,005
	M5x0,8 3118 04 19*	4	-	8,5	13	5	16,5	0,004
4	G1/8 3118 04 10	4	13	8,5	17	7	18,5	0,012
	M5x0,8 3118 06 19*	4	-	10,5	13	7	18,5	0,004
6	G1/8 3118 06 10	4	13	10,5	17	7	20	0,013
	G1/4 3118 06 13	5,5	17	10,5	21	9,5	22	0,023
	G1/8 3118 08 10	4	13	13,5	16,5	7	25	0,014
8	G1/4 3118 08 13	5,5	17	13,5	21	9	27	0,024
	G3/8 3118 08 17	5,5	20	13,5	24,5	11	29	0,038
	G1/4 3118 10 13	5,5	17	16	21	9,5	29	0,025
10	G3/8 3118 10 17	5,5	20	16	24,5	11	31	0,039
	G1/2 3118 10 21	8	25	19	27,5	13,5	36,5	0,083
12	G3/8 3118 12 17	5,5	20	19	24,5	11	34,5	0,040
	G1/2 3118 12 21	8	25	19	27,5	13,5	36,5	0,075

* Con ranura para destornillador

3018 Banjo simple, rosca macho BSPT

Polímero técnico, Latón niquelado, NBR

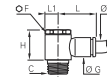

ØD	C	F	G	H	L	L1	Kg
6	R1/8 3018 06 10	13	10,5	18,5	20	7	0,015
	R1/4 3018 06 13	17	10,5	22,5	22	9,5	0,029
8	R1/8 3018 08 10	13	13,5	18,5	25	7	0,016
	R1/4 3018 08 13	17	13,5	22,5	27	9,5	0,030
10	R1/4 3018 10 13	17	16	22,5	29	9,5	0,031
	R3/8 3018 10 17	21	16	26,5	31	11	0,048
12	R1/4 3018 12 13	21	19	26,5	34,5	11	0,052
	R3/8 3018 12 17	21	19	26,5	34,5	11	0,050

Rosca con "pre-coating"

Racores instantáneos LF 3000® / Racores banjos

3124 Banjo simple, macho y hembra BSPP y métrica

Polímero técnico, Latón niquelado, NBR

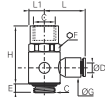

ØD	C		E	F	G	H	L	L1	Kg
4	G1/8	3124 04 10	4	13	8,5	25,5	18,5	7	0,015
6	G1/4	3124 06 13	5,5	17	10,5	33	22	9	0,029
8	G3/8	3124 08 17	5,5	20	13,5	37,5	29	11	0,043

Este modelo ha sido diseñado para la conexión de un racor con funciones neumáticas a la salida de un cilindro.

3538 Cuerpo simple para banjo

Polímero técnico, NBR

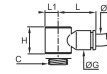

ØD	C		G	H	L	L1	Kg
4	M5x0,8	3538 04 19	8,5	13	16	5	0,001
	G1/8	3538 04 10	10,5	14,5	18,5	7	0,002
6	M5x0,8	3538 06 19	11	13	18,5	5	0,002
	G1/8	3538 06 10	10,5	14,5	20	7	0,002
8	G1/4	3538 06 13	13,5	18	22	9,5	0,003
	G1/8	3538 08 10	13,5	14,5	25	7	0,003
8	G1/4	3538 08 13	13,5	18	27	9,5	0,004
	G3/8	3538 08 17	13,5	21,5	29	11,5	0,005
10	G1/4	3538 10 13	16	18	29	9,5	0,005
	G3/8	3538 10 17	16	21,5	31	11,5	0,006
12	G3/8	3538 12 17	19	21,5	34,5	11,5	0,008

3149 Banjo doble en Y, rosca macho BSPP y métrica

Polímero técnico, Latón niquelado, NBR

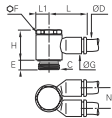

ØD	C		E	F	G	H	L	L1	N	Kg
4	M5x0,8	3149 04 19*	4		8,5	13	16	4,5	9	0,005
	G1/8	3149 04 10	4	13	10,5	16,5	18,5	7	11,5	0,018
6	G1/8	3149 06 10	4	13	10,5	16,5	18,5	7	11,5	0,014
	G1/4	3149 06 13	5,5	17	13,5	21	27	9,5	14,5	0,035
8	G1/4	3149 08 13	5,5	17	13,5	21	27	9,5	14,5	0,026
	G3/8	3149 08 17	5,5	20	16	24,5	31	11	17	0,053
10	G3/8	3149 10 17	5,5	20	16	24,5	31	11	17	0,042

* Con ranura para destornillador

3539 Cuerpo doble opuesto para banjo

Polímero técnico, NBR

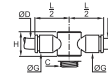

ØD	C		G	H	L/2	Kg
6	G1/8	3539 06 10	10,5	14,3	20	0,011
	G1/4	3539 06 13	13,5	18	26	0,015
8	G1/4	3539 08 13	13,5	18	27	0,005
	G3/8	3539 08 17	16	21,5	30,5	0,020
10	G3/8	3539 10 17	16	21,5	31	0,008

3119 Banjo doble opuesto, rosca macho BSPP y métrica

Polímero técnico, Latón niquelado, NBR

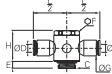

ØD	C		E	F	G	H	L/2	Kg
4	M5x0,8	3119 04 19*	4		8,5	13	8	0,005
	G1/8	3119 06 10	4	13	11	17	20	0,014
6	G1/4	3119 06 13	5,5	17	13,5	21	26,5	0,035
	G1/4	3119 08 13	5,5	17	13,5	21	27	0,026
8	G3/8	3119 08 17	5,5	20	16	24,5	30,5	0,053

* Con ranura para destornillador

3549 Cuerpo doble en Y para banjo

Polímero técnico, NBR

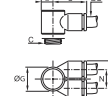

ØD	C		G	K	L	N	Kg
4	M5x0,8	3549 04 19	10	17,5	15,5	9	0,003
	G1/4	3549 04 13	18,5	28	25	14,5	0,020
	G1/8	3549 06 10	14	22,5	20,5	12	0,003
6	G1/4	3549 06 13	18,5	28	25	14,5	0,015
	G3/8	3549 06 17	22,5	33	28,5	17	0,031
8	G1/4	3549 08 13	18,5	28	26	14,5	0,006
	G3/8	3549 08 17	22,5	33	29,5	17	0,020
10	G3/8	3549 10 17	22,5	33	29,5	17	0,009

Racores instantáneos LF 3000® / Racores banjos modulares



3527 Tornillo taladrado para 1 modulo, rosca macho BSPP y métrica

Latón niquelado, NBR



C	F	H	H1	Kg
M5x0,8 3527 00 19*	17	7,5	0,003	
G1/8 3527 00 10	13	17	7,5	0,011
G1/4 3527 00 13	17	21	9,5	0,020
G3/8 3527 00 17	20	24,5	11	0,033

* Con ranura para destornillador
Paso total

3529 Tornillo taladrado para 3 módulos, rosca macho BSPP

Latón niquelado, NBR

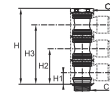

C	F	H	H1	H2	H3	Kg
G1/8 3529 00 10	13	45,5	7,5	22	36	0,023
G1/4 3529 00 13	17	54	9,5	27,5	45,5	0,042
G3/8 3529 00 17	20	67,5	11	32,5	54	0,069

Paso total
Apilado de 3 módulos

3528 Tornillo taladrado para 2 módulos, rosca macho BSPP y métrica

Latón niquelado, NBR

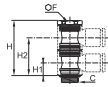

C	F	H	H1	H2	Kg
M5x0,8 3528 00 19*	24,5	7,5	18,5	0,005	
G1/8 3528 00 10	13	31	7,5	22	0,017
G1/4 3528 00 13	17	39	9,5	27,5	0,031
G3/8 3528 00 17	20	46	11	32,5	0,053

* Con ranura para destornillador
Paso total
Producto diseñado para apilar 2 cuerpos de banjo

3524 Tornillo para cuerpo banjo, rosca macho y hembra BSPP y métrica

Latón niquelado, NBR



C	F	H	H1	Kg
G1/8 3524 00 10	13	24,5	7,5	0,013
G1/4 3524 00 13	17	33	9,5	0,027
G3/8 3524 00 17	20	37,5	11	0,039
G1/2 3524 00 21	26	42	11,5	0,067

Paso total

01 // Racores

Racores instantáneos

LF 3000®

El conjunto de tornillos taladrados 3527, 3528, 3529 y 3524 sólo puede utilizarse con los cuerpos para racores múltiples modulares 3538, 3539 y 3549. Paso del tornillo en función de su rosca, para las referencias 3527, 3528, 3529 y 3524.

Rosca	M5x0,8	G1/8	G1/4	G3/8	G1/2
	2,5	5,5	8,5	11	13

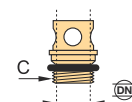

Racores instantáneos LF 3000® / Multiconectores modulares



Solución modular que permite orientar el tubo según la aplicación.

Ø métrico:
Ø 4 a 8 mm

Características técnicas

- **Fluidos adecuados:** Aire comprimido
Otros fluidos: consúltenos
- **Presión de trabajo:** De vacío hasta 10 bar
- **Temperatura de trabajo:** -20°C a +80°C

Las prestaciones dependen de los fluidos, del material y del tubo utilizados. El uso está garantizado para un vacío de 755 mm Hg (99% de vacío).

Ventajas

- Atornillado desde arriba, para un espacio mínimo entre las conexiones
- El tubo se puede girar 360°
- Es posible apilar hasta 6 banjos de un solo paso

Materiales

Sin silicona

- Soporte multiconector:
- en línea: acero cincado
 - en mazo: aluminio y polímero técnico
 - en borne: polímero técnico

Conectores: materiales LF 3000®



Reglamentaciones

- ISO 14743
- PED
- RoHS
- REACH

Configuraciones de instalación

En línea

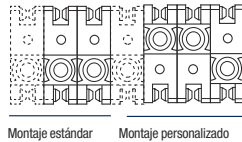

Composición de una caja:
10 módulos hermafroditas
20 puntas de montaje y 4 de extremos
4 patas de fijación
4 grapas de acoplamiento
1 horquilla de expulsión de puntas

En mazo de cables



En borne



El multiconector se obtiene mediante el enganche a presión de módulos hermafroditas, agrupados por puntas. Una grapa lo mantiene cerrado. Una horquilla permite el desmontaje. Se recomiendan 5 módulos como máximo para la parte móvil; la parte fija no está limitada.

3300 Multiconectores modulares

Polímero técnico, NBR

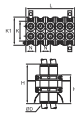

ØD		B	H	H1	K	K1	L	L1	L2	N	Kg
4	3300 04 00	21	40,5	29,5	32	20	55	22	6	11	0,079
6	3300 06 00	28	48	38,5	39	27,5	70	28	7,5	14	0,213
8	3300 08 00	28	50	39	39	27,5	70	28	7,5	14	0,125

Fijación por tornillo o perno de Ø 3 mm

3320 Multi-conector cilíndrico rosca macho

Polímero técnico, NBR

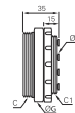

ØD	C	C1		Número de salidas	G	Kg
4	M46x1.5	M40x1.5	3320 04 00 04	4	50	0,069
	M46x1.5	M40x1.5	3320 04 00 07	7	50	0,071
	M65x1.5	M58x1.5	3320 04 00 12	12	70	0,137
6	M46x1.5	M40x1.5	3320 06 00 04	4	50	0,070
	M46x1.5	M40x1.5	3320 06 00 07	7	50	0,073

El número de salidas de tubo del cuerpo macho debe ser igual al del cuerpo hembra.

Racores instantáneos LF 3000® / Multiconectores modulares

3321 Multi-conector cilíndrico cuerpo rosca hembra

Polímero técnico, NBR

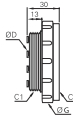



ØD	C	C1		Número de salidas	G	Kg
	M46x1.5	M40x1.5	3321 04 00 04	4	55	0,065
4	M46x1.5	M40x1.5	3321 04 00 07	7	55	0,063
	M65x1.5	M58x1.5	3321 04 00 12	12	75	0,125
	M46x1.5	M40x1.5	3321 06 00 04	4	55	0,065
6	M46x1.5	M40x1.5	3321 06 00 07	7	55	0,064

El número de salidas de tubo del cuerpo hembra debe ser igual al del cuerpo macho.

3329 Multi-conector cilíndrico casquillo a rosca

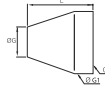
Polímero técnico



C		Número de salidas	G	G1	L	Kg
M40x1.5	3329 00 02	4-7	35	50	55	0,062
M58x1.5	3329 00 03	12	34	70	70	0,139

3379 Borne de conexión para 2 tubos

Polímero técnico, NBR

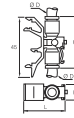



ØD		H	K	L	Kg
4	3379 04 00	34,5	11	39,5	0,010
6	3379 06 00	34,5	11	39,5	0,006
8	3379 08 00	46	13	44,5	0,008

Testigo visual de presión

3381 Borne de conexión para 2 tubos

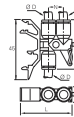
Polímero técnico, NBR



ØD		H	K	L	N	Kg
4	3381 04 00	36,5	11	39,5	11,5	0,013
6	3381 06 00	36,5	11	39,5	11,5	0,007
8	3381 08 00	46	13	44,5	14,5	0,033

Testigo visual de presión

Dimensiones del multi-conector utilizado como pasatabiques

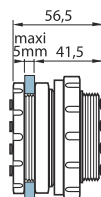
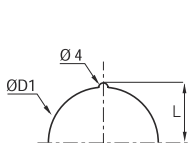

Número de salidas	L	ØD1
2	17	32,5
4-7	21	40,5
12	30,3	58,5

Racores instantáneos LF 3000® / Racores auto-obturantes y giratorios



2 funciones disponibles para una rápida intervención en las máquinas y para facilitar el funcionamiento de las instalaciones.

Ø métrico:
4 a 12 mm

Características técnicas

- **Fluidos adecuados:** Aire comprimido
Otros fluidos: consúltenos
- **Presión de trabajo:** De vacío hasta 20 bar
(10 bar: racor auto-obturante)
- **Temperatura de trabajo:** -20°C a +80°C

Las prestaciones dependen de los fluidos, del material y del tubo utilizados.
El uso está garantizado para un vacío de 755 mm Hg (99% de vacío).

Ventajas

Auto-obturante:

- Cerrar el circuito aguas arriba cuando el tubo está desconectado. Restablecimiento del circuito al conectar.

Girando:

- Acompañamiento del acoplamiento al mover el cilindro: no se dobla el tubo
- Elevada resistencia del acoplamiento / par del tubo.

Materiales

Racor giratorio

- Cuerpo:
- Racor obturante: latón niquelado
- Racor giratorio: polímero técnico

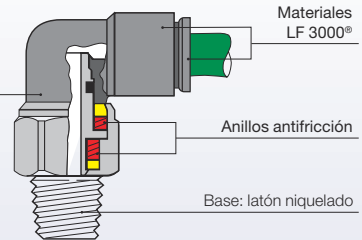

Sin silicona

Reglamentaciones

- ISO 14743
- PED
- RoHS
- REACH

Configuraciones de instalación

Racor auto-obturante

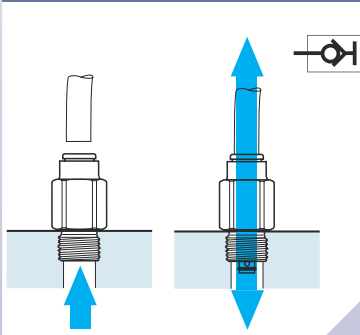

Racor giratorio

Ø exterior tubo (mm)	Par de maniobra (daN.m)	Velocidad máx. en rpm
4	$2,5 \cdot 10^{-3}$	190
6	$4 \cdot 10^{-3}$	160
8	$7 \cdot 10^{-3}$	120
10	$11 \cdot 10^{-3}$	90
12	$16 \cdot 10^{-3}$	80

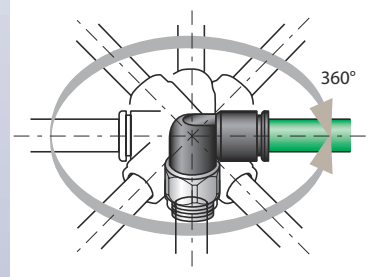

3391 Racor recto auto-obturante, rosca macho BSPP

Latón niquelado, NBR

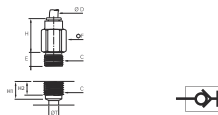

ØD	C		E	F	H	H1	H2	ØT	Kg
4	G1/8	3391 04 10	5	13	18	7,5	6	5	0,017
6	G1/8	3391 06 10	5	14	19,5	9	6	7,5	0,018
8	G1/8	3391 08 10	5	14	29,5	10	6	7,5	0,025
	G1/4	3391 08 13	5,5	16	25,5	11	8	9	0,032
10	G3/8	3391 10 17	5,5	20	27,5	13	11	10	0,055

Presión máx de servicio: 10 bar

3091 Racor recto auto-obturante, rosca macho BSPT

Latón niquelado, NBR

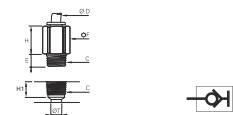

ØD	C		E	F	H	H1	ØT	Kg
4	R1/8	3091 04 10	7,5	12	18	9,5	5	0,014
6	R1/8	3091 06 10	7,5	13	19,5	9,5	7,5	0,015
	R1/8	3091 08 10	6,5	14	25	10,5	7,5	0,024
8	R1/4	3091 08 13	11	14	25,5	13,5	9	0,021

Presión máx de servicio: 10 bar
Rosca con "pre-coating"

Racores instantáneos LF 3000® / Racores auto-obturantes y giratorios

3160 Racor auto-obturante enclavable

Polímero técnico, NBR

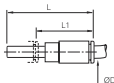

ØD		L	L1	Kg
4	3160 04 00	46	33,5	0,006
6	3160 06 00	53,5	31	0,009
8	3160 08 00	58	31	0,014

3159 Codo oscilante, rosca macho BSPT

Polímero técnico, Latón niquelado, NBR

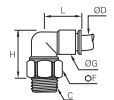

ØD	C		F	G	H	L	Kg
4	R1/8	3159 04 10	12	11	22	17,5	0,013
	R1/8	3159 06 10	14	14	26,5	20,5	0,020
6	R1/4	3159 06 13	14	14	23,5	20,5	0,022
	R1/8	3159 08 10	17	16	32	23,5	0,034
8	R1/4	3159 08 13	17	16	29	23,5	0,034
	R3/8	3159 08 17	17	16	25	23,5	0,031
10	R1/4	3159 10 13	19	19,5	37,5	29	0,051
	R3/8	3159 10 17	19	19,5	33,5	29	0,046
12	R1/4	3159 12 13	21	22	44,5	33,5	0,074
	R3/8	3159 12 17	21	22	41	33,5	0,068

Rosca con "pre-coating"

3189 Codo oscilante, rosca macho BSPP y métrica

Polímero técnico, Latón niquelado, NBR

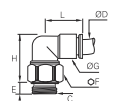

ØD	C		E	F	G	H	L	Kg
4	M5x0,8	3189 04 19	3	12	11	24,5	17,5	0,012
	G1/8	3189 04 10	5	13	11	23	17,5	0,014
6	M5x0,8	3189 06 19	3	12	14	27,5	20,5	0,017
	G1/8	3189 06 10	5	14	14	27	20,5	0,019
	G1/4	3189 06 13	5,5	16	14	25,5	20,5	0,023
	G1/8	3189 08 10	5	17	16	33,5	23,5	0,034
8	G1/4	3189 08 13	5,5	17	16	31	23,5	0,032
	G3/8	3189 08 17	5,5	20	16	29,5	23,5	0,039
10	G1/4	3189 10 13	5,5	19	19,5	39	29	0,053
	G3/8	3189 10 17	5,5	20	19,5	37	29	0,051
12	G1/4	3189 12 13	5,5	21	22	46,5	33,5	0,073
	G3/8	3189 12 17	5,5	21	22	45,5	33,5	0,071

Racores instantáneos LF 3000® / Kits de mantenimiento



La herramienta esencial para realizar rápidamente las principales operaciones de mantenimiento y reducir las paradas de producción.

Ventajas

- 2 kits disponibles: para productos BSPP y BSPT
- 24 referencias que engloban los productos más comunes
- Productos disponibles en los diámetros más comunes: 4 mm, 6 mm y 8 mm
- Un kit contiene más de 300 productos y puede ser fácilmente completado con nuestros productos estándar

Referencias comunes a ambos kits

ØD	Referencias	Ctd	ØD	Referencias	Ctd
4	3104 04 00	10	4	3106 04 00	10
6	3104 06 00	10	6	3106 06 00	10
8	3104 08 00	10	8	3106 08 00	10
ØD1	ØD2	Referencias	Ctd		
4	6	3166 04 06	10		
6	8	3166 06 08	10		
ØD	Referencias	Ctd			
4	3126 04 00	20			
6	3126 06 00	20			
8	3126 08 00	20			
			3000 71 00		1
			0605 12 12		1

+

REFERENCIAS ADICIONALES BSPP KIT

ØD	C	Referencias	Ctd
4	G1/8	3101 04 10	20
6	M5x0,8	3101 06 19	20
6	G1/8	3101 06 10	20
6	G1/4	3101 06 13	20
8	G1/4	3101 08 13	20
4	M5x0,8	3199 04 19	10
4	G1/8	3199 04 10	10
6	M5x0,8	3199 06 19	10
6	G1/8	3199 06 10	10
6	G1/4	3199 06 13	10
8	G1/4	3199 08 13	10

REFERENCIAS ADICIONALES BSPT KIT

ØD	C	Referencias	Ctd
4	R1/8	3175 04 10	20
4	R1/4	3175 04 13	20
6	R1/8	3175 06 10	20
6	R1/4	3175 06 13	20
8	R1/4	3175 08 13	20
4	R1/8	3109 04 10	10
6	R1/8	3109 06 10	10
6	R1/4	3109 06 13	10
8	R1/8	3109 08 10	10
8	R1/4	3109 08 13	10

3150..57 Kit de mantenimiento, BSPP



	H	L	L1	Kg
3150 00 01 57UN	81	413	330	3,221

3150..58 Kit de mantenimiento, BSPP



	H	L	L1	Kg
3150 00 01 58UN	81	413	330	3,750

Racores instantáneos LF 3200 (3 mm)



Una gama miniaturizada y ergonómica que mantiene altas características mecánicas.

Ø métrico:
3 mm

Características técnicas

- **Fluidos adecuados:** Aire comprimido
- **Presión de trabajo:** De vacío hasta 20 bar
- **Temperatura de trabajo:** -15°C a +80°C
- **Par de apriete (daN.m):** 0,01 a 0,1

Las prestaciones dependen de los fluidos, del material y del tubo utilizados. El uso está garantizado para un vacío de 755 mm Hg (99% de vacío).

Ventajas

- Optimización del equipo: peso, tamaño.
- Componentes de latón niquelado para una mejor resistencia al impacto y a la corrosión
- Presiones de funcionamiento: desde vacío hasta 20 bar

Materiales

Sin silicona

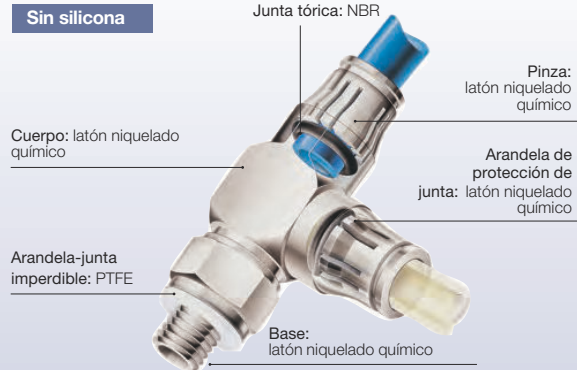

Reglamentaciones

- ISO 14743
- PED
- RoHS
- ATEX (consúltenos)
- REACH

3281 Racor de entrada recto, rosca macho métrica

Latón niquelado, NBR



ØD	C		F	G	H	Kg
3	M3x0,5	3281 03 09	1,5	6	9,5	0,001
	M5x0,8	3281 03 19	1,5	8	9,5	0,002

3229 Codo elevado, rosca macho métrica

Latón niquelado, NBR



ØD	C		F	G	H	J	L	Kg
3	M3x0,5	3229 03 09	6	6	16	6	13,5	0,004
	M5x0,8	3229 03 19	8	6	17	6	13,5	0,005

3299 Codo compacto, rosca macho métrica

Latón niquelado, NBR



ØD	C		F	G	H	J	L	Kg
3	M3x0,5	3299 03 09	6	6	13,5	6	13,5	0,004
	M5x0,8	3299 03 19	8	6	13	6	13,5	0,005

3298 Te, rosca macho central métrica

Latón niquelado, NBR

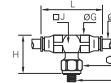

ØD	C		F	G	H	J	L	Kg
3	M3x0,5	3298 03 09	6	6	13,5	6	20,5	0,004
	M5x0,8	3298 03 19	8	6	13	6	20,5	0,005

Racores instantáneos LF 3200 (3 mm)

3293 Te, rosca macho central métrica

Latón niquelado, NBR

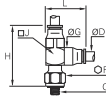

ØD	C		F	G	H	J	L	Kg
3	M3x0,5	3293 03 09	6	6	20	6	13,5	0,004
	M5x0,8	3293 03 19	8	6	20	6	13,5	0,005

3204 Te igual

Latón niquelado, NBR

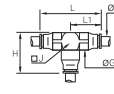

ØD			G	H	J	L	L1	Kg
3	3204 03 00		6	13,5	6	20,5	10,5	0,004

3218 Banjo simple, rosca macho métrica

Latón niquelado, NBR

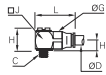

ØD	C		G	H	H1	J	L	Kg
3	M3x0,5	3218 03 09	6	9,5	4	6	12,5	0,002
	M5x0,8	3218 03 19	6	10,5	4,5	8	15	0,005

3266 Reductor enclavable

Latón niquelado, NBR, Polímero técnico

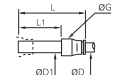

ØD	ØD1		G	L	L1	Kg
3	4	3266 03 04	6	28	19	0,001

3206 Unión doble igual

Latón niquelado, NBR



ØD			G	L	Kg
3	3206 03 00		6	17	0,002

3226 Tapón enclavable

Latón niquelado

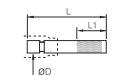

ØD			L	L1	Kg
3	3226 03 00		20	10	0,004

3202 Codo igual

Latón niquelado, NBR

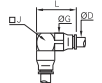

ØD			G	J	L	Kg
3	3202 03 00		6	6	13,5	0,003

Configuraciones de instalación

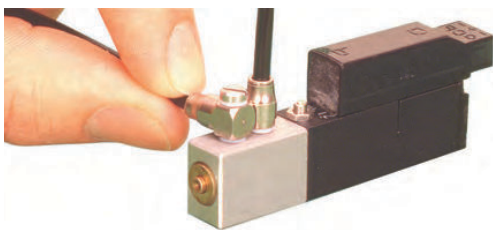

El LF 3200, asociado a un tubo de poliuretano y poliuretano antiestático en 3 mm es la mejor solución para:

- proteger los microsistemas sometidos a fuertes solicitaciones
- aumentar la fiabilidad de los microsistemas

Racores instantáneos LIQUIfit®

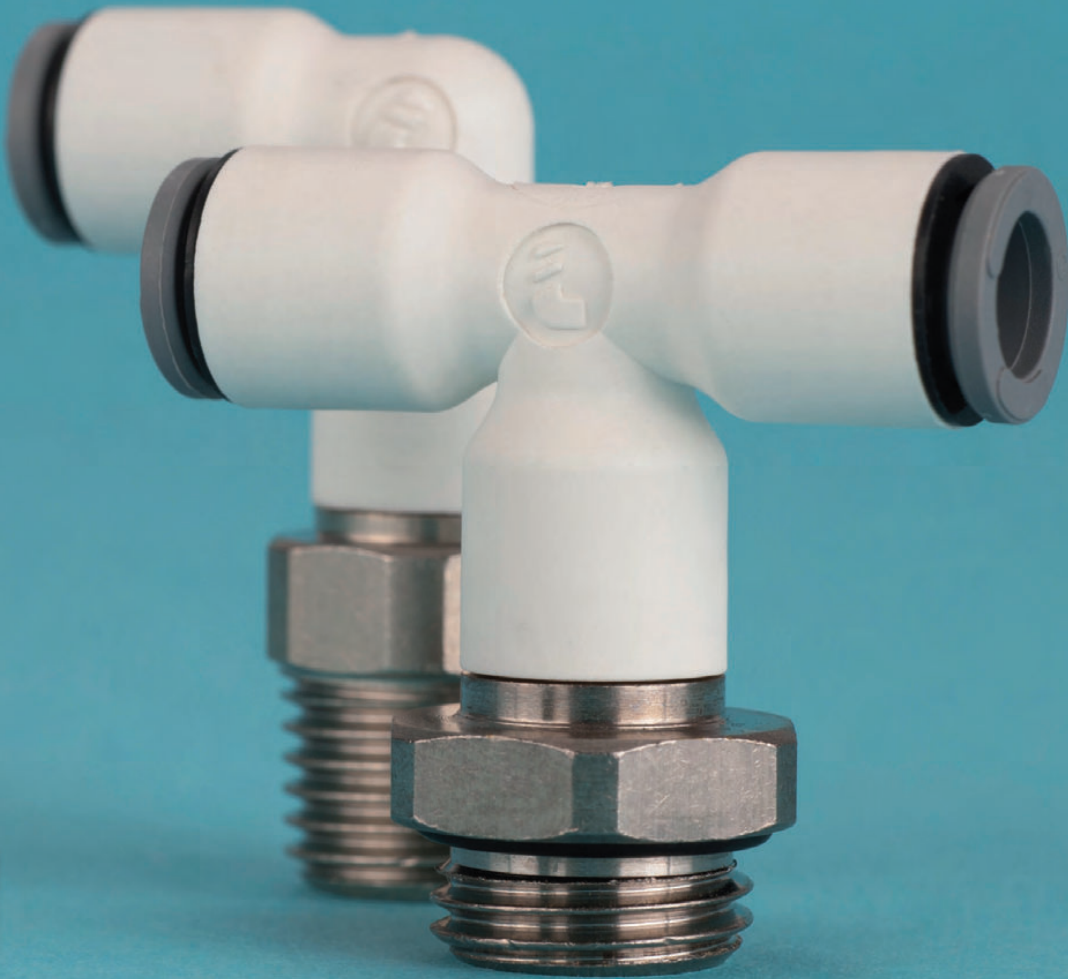

Racores instantáneos LIQUIfit® / Racores de implantación



Conectores innovadores y compactos para la transferencia de fluidos y líquidos.

Ø métrico: 4 a 16 mm
Ø pulgadas: 1/4" a 1/2"

Características técnicas

- **Fluidos adecuados:** Agua, bebidas, CO₂ (utilización estática)
Fluidos químicos: consúltenos
- **Presión de trabajo:** De vacío hasta 16 bar
- **Temperatura de trabajo:**
-10°C a +130°C (hasta 10 bar) para racores uniones 4, 6, 8 mm
-10°C a +95°C para todos otros racores

Par de apriete máx. (BSPT/NPTF)	Rosca	1/8" y 1/4"	3/8" y 1/2"
		daN.m	0,15

Las prestaciones dependen de los fluidos, del material y del tubo utilizados.
El uso está garantizado para un vacío de 755 mm Hg (99% de vacío).

Ventajas

- Polímeros con biosourcing de acuerdo con la normativa alimentaria
- Compatibilidad con las normas FDA, NSF, DM174, WRAS, KTW, ACS
- Formas exteriores fáciles de limpiar
- Sin bisfenol y sin ftalatos

Materiales

Sin silicona

Botón pulsador:
polímero técnico

Cuerpo y base:
polímero de origen ecológico

Junta: EPDM

Arandela
(6501 y 6599):
acero inoxidable



**ECO
DESIGN**

Reglamentaciones

- RoHS
- REACH
- FDA: 21 CFR
- NSF: 51
- NSF 61 - C HOT
- 1935/2004
- DM 174
- ACS
- WRAS
- KTW
- W270

Rendimiento en presiones y temperaturas de los distintos diámetros de la gama LIQUIfit® y de los productos asociados

-10°C		Presión (bar)	
mm Ø	Pulgadas Ø	Racores	Tubos PE
4	5/32	16	16
6	1/4	16	16
8	5/16	16	16
10	3/8	13	15
12	1/2	11	11

+1°C		Presión (bar)	
mm Ø	Pulgadas Ø	Racores	Tubos PE
4	5/32	16	16
6	1/4	16	16
8	5/16	16	16
10	3/8	13	15
12	1/2	11	11

+20°C		Presión (bar)	
mm Ø	Pulgadas Ø	Racores	Tubos PE
4	5/32	16	16
6	1/4	16	16
8	5/16	16	16
10	3/8	13	15
12	1/2	11	11

+40°C		Presión (bar)	
mm Ø	Pulgadas Ø	Racores	Tubos PE
4	5/32	16	16
6	1/4	16	16
8	5/16	16	16
10	3/8	13	15
12	1/2	11	11

+65°C		Presión (bar)	
mm Ø	Pulgadas Ø	Racores	Tubos PE
4	5/32	12	10
6	1/4	12	10
8	5/16	12	10
10	3/8	7	7
12	1/2	7	7

+95°C		Presión (bar)	
mm Ø	Pulgadas Ø	Racores	Tubos PE
4	5/32	12	4
6	1/4	12	4
8	5/16	12	4
10	3/8	4	4
12	1/2	4	4

Racores instantáneos LIQUIfit® / Racores de implantación

6501 Racor de entrada recto, rosca macho BSPP

POM, EPDM



ØD	C		E	F	G	H	Kg
6	G1/8	6501 06 10WP2	6	15	18	18	0,003
	G1/4	6501 06 13WP2	8,5	18	18	18,5	0,004
8	G1/8	6501 08 10WP2	6	17	18	18,5	0,005
	G1/4	6501 08 13WP2	8,5	18	18	20	0,006
10	G3/8	6501 08 17WP2	6	21	20	17,5	0,007
	G1/4	6501 10 13WP2	8,5	19	20	22	0,007
12	G3/8	6501 10 17WP2	9	21	20	17	0,007
	G1/2	6501 10 21WP2	12,5	26	21,5	17	0,011
12	G3/8	6501 12 17WP2	9	24	21,5	25	0,011
	G1/2	6501 12 21WP2	12,5	26	21,5	20	0,012

Tecnología de pinzas
Sólo certificado por la NSF

6505 Racor de entrada recto, rosca macho BSPT

Bio-polímero, EPDM

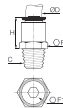

ØD	C		F	F1	H	Kg
4	R1/8	6505 04 10WP2	11	3	18	0,003
	R1/4	6505 04 13WP2	14	3	18	0,004
6	R1/8	6505 06 10WP2	11	4	18	0,002
	R1/4	6505 06 13WP2	14	4	18	0,004
8	R1/8	6505 08 10WP2	17	6	20	0,004
	R1/4	6505 08 13WP2	14	6	20	0,004
10	R3/8	6505 08 17WP2	17	6	20	0,005
	R1/4	6505 10 13WP2	17	7	21,5	0,005
12	R3/8	6505 10 17WP2	19	7	21,5	0,007
	R1/2	6505 10 21WP2	22	7	21,5	0,010
12	R3/8	6505 12 17WP2	19	9	24,5	0,008
	R1/2	6505 12 21WP2	22	9	24,5	0,012

6505 Racor de entrada recto, rosca macho NPTF

Pulgadas

Bio-polímero, EPDM

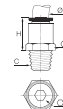

ØD	C		F	F1	H	Kg
1/4	NPT1/8	6505 56 11WP2	1/2	5/32	17	0,002
	NPT1/4	6505 56 14WP2	9/16	5/32	17	0,003
3/8	NPT1/4	6505 60 14WP2	3/4	1/4	22	0,006
	NPT3/8	6505 60 18WP2	3/4	1/4	22	0,007
1/2	NPT3/8	6505 62 18WP2	15/16	3/8	28	0,012
	NPT1/2	6505 62 22WP2	15/16	3/8	28	0,013

Rosca sin pre-coating.

6505 Racor de entrada recto, rosca macho BSPT

Pulgadas

Bio-polímero, EPDM

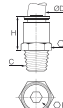

ØD	C		F	F1	H	Kg
1/4	R1/8	6505 56 10WP2	11	5	17	0,002
	R1/4	6505 56 13WP2	14	5	17	0,003
3/8	R3/8	6505 60 17WP2	19	7	22	0,006
	R1/2	6505 60 21WP2	22	7	28	0,012
1/2	R1/2	6505 62 21WP2	24	9	28	0,017

Rosca sin pre-coating.
5/32" (4 mm) y 5/16" (8 mm) también disponible.

6315 Racor de entrada recto, rosca hembra BSPT

Bio-polímero, EPDM

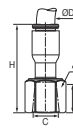

ØD	C		E	F	H	Kg
6	R1/8	6315 06 10WP2	11	13	32	0,003
	R1/4	6315 06 13WP2	14	16	33	0,004
8	R1/4	6315 08 13WP2	14	16	33,5	0,004
	R3/8	6315 08 17WP2	14	20	36	0,009

WP3 = gran cantidad (número de piezas por bolsa: 40, 50 o 100 dependiendo del diámetro).

6315 Racor de entrada recto, rosca hembra NPTF

Pulgadas

Bio-polímero, EPDM

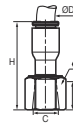

ØD	C		F	H	Kg
1/4	NPT1/4	6315 56 14WP2	11/16	30	0,003
3/8	NPT3/8	6315 60 18WP2	13/16	36	0,007

Racores instantáneos LIQUIfit® / Racores de implantación

6352 Racor de entrada recto, rosca hembra BSPP Pulgadas

Bio-polímero, EPDM

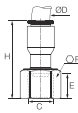

ØD	C	E	F	H	Kg	
3/8	G3/8	6352 60 17WP2	12	22	36	0,008
	G1/2	6352 60 21WP2	12	27	36	0,011

6325 Racor de entrada recto para grifo, rosca hembra UNS Pulgadas

Bio-polímero, EPDM

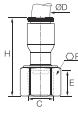

ØD	C	E	F	H	Kg	
1/4	UNS7/16-24	6325 56 133WP2	7	916	31	0,002

6521 Adaptador enclavable, rosca macho BSPT

Bio-polímero



ØD	C	F	H	Kg	
6	R1/8	6521 06 10WP2	13	19	0,002
	R1/4	6521 06 13WP2	14	19	0,003
	R3/8	6521 06 17WP2	17	19	0,004
8	R1/8	6521 08 10WP2	19	23	0,003
	R1/4	6521 08 13WP2	19	23	0,004
	R3/8	6521 08 17WP2	19	23	0,004
10	R1/4	6521 10 13WP2	19	25	0,004
	R3/8	6521 10 17WP2	19	25	0,005
	R1/2	6521 10 21WP2	22	25	0,008
12	R3/8	6521 12 17WP2	22	28	0,005
	R1/2	6521 12 21WP2	22	28	0,007

Rosca sin pre-coating.

6521 Adaptador enclavable, rosca macho BSPT Pulgadas

Bio-polímero

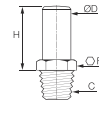

ØD	C	F	H	Kg	
3/8	NPT1/4	6521 60 14WP2	3/4	25	0,004
	NPT3/8	6521 60 18WP2	3/4	25	0,004

Rosca sin pre-coating.

6521 Adaptador enclavable, rosca macho BSPT Pulgadas

Bio-polímero

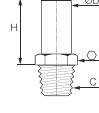

ØD	C	F	H	Kg	
1/4	R1/8	6521 56 10WP2	14	19	0,002
	R1/4	6521 56 13WP2	14	19	0,002
	R3/8	6521 56 17WP2	17	19	0,004
3/8	R3/8	6521 60 17WP2	19	25	0,004

Rosca sin pre-coating. 5/16" (8mm) también disponible.

6300 Cartucho monobloque LIQUIfit®

Latón, EPDM



ØD	G	G1	H	L	Kg	
4	6300 04 00	8	11	10	554	0,002
6	6300 06 00	10	14,5	11,5	629	0,002
8	6300 08 00	13	15	15	794	0,003
10	6300 10 00	15,5	19,5	17	930	0,005
12	6300 12 00	18,5	21	19,5	1 038	0,010

50 cartuchos en cada funda Carstick®
 Rogamos consulten con nosotros para obtener el plano detallado necesario para la realización de los alojamientos, así como sus materiales.



Principio de obturación para racores rectos hembra roscado

Racor de entrada recto, rosca hembra NPTF, 6315

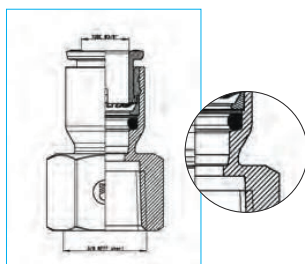

Racor de entrada recto, rosca hembra BSPP, 6352

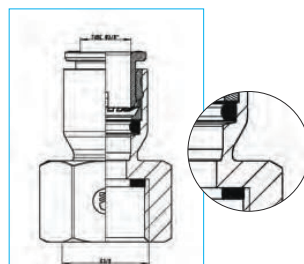

Racores instantáneos LIQUIfit® / Racores de implantación



01 // Racores

Racores instantáneos

LIQUIfit®

6300 Cartucho monobloque LIQUIfit® Pulgadas

Latón, EPDM



ØD		G	G1	H	L	Kg
1/4	6300 56 00	10,5	14,5	12,5	600	0,002
3/8	6300 60 00	15,5	19	17	930	0,005
1/2	6300 62 00	22	25	23	1038	0,011

50 cartuchos en cada funda Carstick®
5/32" (4mm) y 5/16" (8 mm) también disponible.
Rogamos consulten con nosotros para obtener el plano dyallado necesario para la realización de los alojamientos, así como sus materiales.



6599 Racor de entrada recto, rosca macho BSPP

POM, EPDM



ØD	C	E	F	G	H	Kg
6	G1/8 6599 06 10WP2	6	17	15	24,5	0,007
	G1/4 6599 06 13WP2	8,5	18	15	33	0,008
8	G1/8 6599 08 10WP2	6	18	17,5	26	0,010
	G1/4 6599 08 13WP2	8,5	18	17,5	26	0,011
10	G3/8 6599 08 17WP2	9	22	17,5	26	0,012
	G1/4 6599 10 13WP2	8,5	22	20	29,5	0,015
12	G3/8 6599 10 17WP2	9	22	20	29,5	0,015
	G1/2 6599 10 21WP2	12,5	26	20	29,5	0,019
12	G3/8 6599 12 17WP2	9	26	23	34,5	0,023
	G1/2 6599 12 21WP2	12,5	26	23	34,5	0,025

Tecnología de pinzas. Rosca sin pre-coating. ; cuerpo giratorio.
Sólo certificado por la NSF

6579 Codo rígido, rosca macho BSPT

Bio-polímero, EPDM

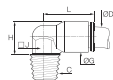

ØD	C	G	H	J	L	Kg
6	R1/8 6579 06 10WP2	11	14	10	19	0,002
	R1/4 6579 06 13WP2	11	14	10	19	0,003
	R3/8 6579 06 17WP2	11	14	10	19	0,004

Rosca sin pre-coating.

6509 Codo, rosca macho BSPT

Bio-polímero, EPDM

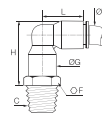

ØD	C	F	G	H	L	Kg
6	R1/8 6509 06 10WP2	13	10,5	28	24	0,037
	R1/4 6509 06 13WP2	14	10,5	28	24	0,007
	R3/8 6509 06 17WP2	17	10,5	28	24	0,008
8	R1/8 6509 08 10WP2	19	13,5	34	29,5	0,010
	R1/4 6509 08 13WP2	19	13,5	34	29,5	0,011
	R3/8 6509 08 17WP2	19	13,5	34	29,5	0,011
10	R1/4 6509 10 13WP2	19	16	38	34,5	0,019
	R3/8 6509 10 17WP2	19	16	38	34,5	0,020
	R1/2 6509 10 21WP2	22	16	38	34,5	0,023
12	R3/8 6509 12 17WP2	22	19	44	40	0,022
	R1/2 6509 12 21WP2	22	19	44	40	0,024

Rosca sin pre-coating ; Racor orientable.

6579 Codo rígido, rosca macho NPTF Pulgadas

Bio-polímero, EPDM

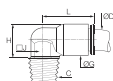

ØD	C	G	H	J	L	Kg
1/4	NPT1/8 6579 56 11WP2	11	22	38	18	0,009
	NPT1/4 6579 56 14WP2	11	26	38	18	0,003
	NPT1/4 6579 60 14WP2	16	32	12	26	0,006

Rosca sin pre-coating.

6509 Codo, rosca macho NPTF Pulgadas

Bio-polímero, EPDM

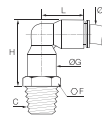

ØD	C	F	G	H	L	Kg
1/4	NPT1/8 6509 56 11WP2	1/2	11	28	23,5	0,003
	NPT1/4 6509 56 14WP2	9/16	11	28	23,5	0,004
	NPT3/8 6509 56 18WP2	3/4	11	28,5	23,5	0,006

Rosca sin pre-coating ; Racor orientable.

Racores instantáneos LIQUIfit® / Racores de implantación

6509 Codo, rosca macho BSPT

Pulgadas

Bio-polímero, EPDM

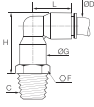

ØD	C		F	G	H	L	Kg
1/2	R1/2	6509 62 21WP2	24	22	50,5	46,5	0,027

5/16" (8 mm) también disponible.
Rosca sin pre-coating ; Racor orientable.

6508 Te, rosca macho central BSPT

Bio-polímero, EPDM

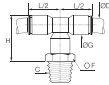

ØD	C		F	G	H	L/2	Kg
6	R1/8	6508 06 10WP2	13	10,5	28	18	0,008
	R1/4	6508 06 13WP2	14	10,5	28	18	0,009
	R3/8	6508 06 17WP2	17	10,5	28	18	0,010
8	R1/8	6508 08 10WP2	19	13,5	34	23	0,012
	R1/4	6508 08 13WP2	19	13,5	34	23	0,013
	R3/8	6508 08 17WP2	19	13,5	34	23	0,013
10	R1/4	6508 10 13WP2	19	16	38	26,5	0,018
	R3/8	6508 10 17WP2	19	16	38	26,5	0,019
	R1/2	6508 10 21WP2	22	16	38	26,5	0,022
12	R1/2	6508 12 21WP2	22	19	44	31	0,026

Rosca sin pre-coating ; Racor orientable.

6503 Te, rosca macho lateral BSPT

Bio-polímero, EPDM

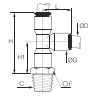

ØD	C		F	G	H	H1	L	Kg
6	R1/4	6503 06 13WP2	14	10,5	40	22	18,5	0,009
	R1/8	6503 08 10WP2	19	13,5	50	27	23	0,012
8	R1/4	6503 08 13WP2	19	13,5	50	27	23	0,013
	R3/8	6503 08 17WP2	19	13,5	50	27	23	0,013
12	R3/8	6503 12 17WP2	22	19	65,5	34,5	31	0,024
	R1/2	6503 12 21WP2	22	19	65,5	34,5	31	0,026

Rosca sin pre-coating ; Racor orientable.

6355 Unión doble desigual, rosca hembra BSPP

Bio-polímero, EPDM



C	C1		E	F	H	Kg
G3/4	G1/4	6355 13 27WP2	10	32	23,5	0,050

Racores instantáneos LIQUIfit® / Racores de unión

6306 Unión igual y desigual

Bio-polímero, EPDM

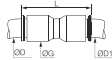

ØD	ØD1		G	L	Kg
4	4	6306 04 00WP2	8,5	26,5	0,002
	6	6306 04 06WP2	10,5	29	0,002
	8	6306 04 08WP2	13,5	37	0,005
6	6	6306 06 00WP2	10,5	30	0,004
	8	6306 06 08WP2	13,5	37	0,005
	10	6306 06 10WP2	16	42	0,007
8	8	6306 08 00WP2	13,5	37	0,004
	10	6306 08 10WP2	16	42	0,007
	12	6306 08 12WP2	19	50	0,012
10	10	6306 10 00WP2	16	42	0,009
	12	6306 10 12WP2	19	50	0,013
12	12	6306 12 00WP2	19	50,5	0,009
16	16	6306 16 00	27	60,5	0,023

6302 Codo igual y desigual

Pulgadas

Bio-polímero, EPDM



ØD	ØD1		G	L	Kg
5/16	3/8	6302 08 60WP2	16	34	0,009
	1/4	6302 56 08WP2	11	24	0,005
1/4	5/16	6302 56 08WP2	13,5	29,5	0,006
	3/8	6302 56 60WP2	16	34	0,008
3/8	3/8	6302 60 00WP2	16	34	0,006
	1/2	6302 60 62WP2	22	46,5	0,011
1/2	1/2	6302 62 00WP2	22	46,5	0,017

6306 Unión igual y desigual

Pulgadas

Bio-polímero, EPDM

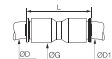

ØD	ØD1		G	L	Kg
5/16	3/8	6306 08 60WP2	16	42	0,008
	1/2	6306 08 62WP2	22	55	0,018
1/4	1/4	6306 56 00WP2	11	30	0,004
	3/8	6306 56 60WP2	16	41	0,007
3/8	3/8	6306 60 00WP2	16	42	0,006
	1/2	6306 60 62WP2	22	56	0,020
1/2	1/2	6306 62 00WP2	22	57	0,016

6304 Te igual

Bio-polímero, EPDM

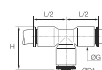

ØD	ØD1		G	H	L/2	Kg
4	4	6304 04 00WP2	8,5	20	15,5	0,004
6	6	6304 06 00WP2	10,5	23	18	0,006
8	8	6304 08 00WP2	13,5	29	22,5	0,006
10	10	6304 10 00WP2	16	34,5	26,5	0,009
12	12	6304 12 00WP2	19	40	31	0,014
16	16	6304 16 00	27	53	39	0,037
	12	6304 16 12	27	53	39	0,063

6302 Codo igual y desigual

Bio-polímero, EPDM

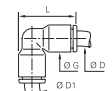

ØD	ØD1		G	L	Kg
4	4	6302 04 00WP2	8,5	19	0,002
	6	6302 04 06WP2	10,5	24	0,004
6	6	6302 06 00WP2	10,5	24	0,004
	8	6302 06 08WP2	13,5	29,5	0,006
8	8	6302 08 00WP2	13,5	29	0,004
	10	6302 08 10WP2	16	34,5	0,008
10	10	6302 10 00WP2	16	34,5	0,005
	12	6302 10 12WP2	19	40,5	0,013
12	12	6302 12 00WP2	19	40,5	0,010
16	16	6302 16 00	27	53	0,024

6304 Te igual y desigual

Pulgadas

Bio-polímero, EPDM

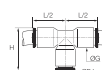

ØD	ØD1		G	H	L/2	Kg
1/4	1/4	6304 56 00WP2	11	24	18	0,002
	3/8	6304 60 00WP2	16	34	26	0,009
3/8	1/4	6304 60 56WP2	16	34	26	0,011
	1/2	6304 62 00WP2	22	47	36	0,027
1/2	3/8	6304 62 60WP2	22	47	36	0,009

5/32" (4mm) y 5/16" (8mm) también disponible

Racores instantáneos LIQUIfit® / Racores de unión

6340 Y simple igual

Bio-polímero, EPDM

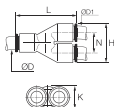

ØD	ØD1		H	K	L	N	Kg
4	4	6340 04 00WP2	17,5	8,5	30	9	0,004
6	6	6340 06 00WP2	21,5	10,5	36,5	11	0,008
8	8	6340 08 00WP2	28	13,5	44,5	14,5	0,007
10	10	6340 10 00WP2	33	16	53	17	0,010
12	12	6340 12 00WP2	39	19	60,5	20	0,025

6340 Y simple igual

Pulgadas

Bio-polímero, EPDM

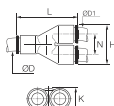

ØD	ØD1		H	K	L	N	Kg
1/4	1/4	6340 56 00WP2	22	11	36	11,5	0,010
3/8	3/8	6340 60 00WP2	33	16	53	17	0,011
1/2	1/2	6340 62 00WP2	45	22	67	23	0,028

5/32" (4mm) y 5/16" (8 mm) también disponible.

6307 Cruz igual

Bio-polímero, EPDM

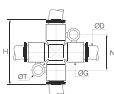

ØD		G	H	N	ØT	Kg
6	6307 06 00WP2	11	36	20	4,2	0,005
8	6307 08 00WP2	13,5	45	22,5	4,2	0,020

6307 Cruz igual

Pulgadas

Bio-polímero, EPDM

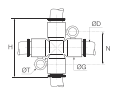

ØD		G	H	L	ØT	Kg
1/4	6307 56 00WP2	11	36	20	4,2	0,010

5/16" (8 mm) también disponible.

Racores instantáneos LIQUIfit® / Racores pasatabiques



6316 Unión doble pasatabiques igual

Bio-polímero, EPDM

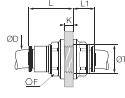

ØD		F	K max	L	L1	ØT min	Kg
4	6316 04 00WP2	13	5.5	15.5	10.5	10.5	0.018
6	6316 06 00WP2	15	8.5	20	10	12.5	0.004
8	6316 08 00WP2	18	14.5	27	10.5	15.5	0.007
10	6316 10 00WP2	22	14.5	30	13	18.5	0.012
12	6316 12 00WP2	26	18.5	35	15.5	22.5	0.020

6316 Unión doble pasatabiques igual Pulgadas

Bio-polímero, EPDM

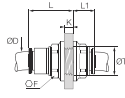

ØD		F	K max	L	L1	ØT min	Kg
1/4	6316 56 00WP2	15	8.5	20	10	12.5	0.004
3/8	6316 60 00WP2	22	14.5	29.5	12.5	18.5	0.012
1/2	6316 62 00WP2	29	20.5	40.5	17	25.5	0.030

5/32" (4mm) y 5/16" (8mm) también disponible

6976 Unión doble pasatabiques

Acero inox 316L, EPDM

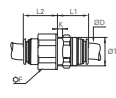

ØD		F	K max	L1	L2	ØT min	Kg
16	6976 16 00	32	10.5	33	30	27.5	0.166

Clase de protección eléctrica IP55

Otros productos de la gama LIQUIfit®

Los otros productos de la gama LIQUIfit® se presentan en los capítulos correspondientes de este catálogo:

Tubos técnicos

Tubo PE



Racores con funciones

Válvulas anti-retorno



Válvulas industriales

LIQUIfit®, Cierre esférico



Racores instantáneos LIQUIfit® / Racores enclavables

6382 Codo igual y desigual con espiga lisa

Bio-polímero, EPDM

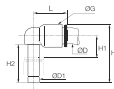

ØD	ØD1		G	H	H1	H2	L	Kg
4	4	6382 04 00WP2	8,5	23	6	15,5	15	0,003
	6	6382 04 06WP2	10,5	26,5	7	17	16,5	0,002
6	6	6382 06 00WP2	10,5	26,5	7	17	17	0,003
	4	6382 06 04WP2	10,5	25	7	15,5	17	0,001
8	8	6382 06 08WP2	13,5	33,5	8	21,5	22,5	0,004
	8	6382 08 00WP2	13,5	33,5	8	21,5	22,5	0,004
10	10	6382 08 10WP2	16	39	9,5	24,5	26	0,007
	10	6382 10 00WP2	16	39	9,5	24,5	26,5	0,004
12	12	6382 10 12WP2	19	44,5	10	27	30	0,011
	12	6382 12 00WP2	19	44,5	10	27	31	0,012

Las referencias en el diámetro de 4 mm y 12 mm no son ranuradas en la versión estándar.

6383 Te igual con espiga lisa lateral

Bio-polímero, EPDM

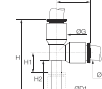

ØD	ØD1		G	H	H1	H2	L	Kg
4	4	6383 04 00WP2	8,5	33	6	15,5	15	0,002
6	6	6383 06 00WP2	10,5	38,5	7	17	18	0,002
8	8	6383 08 00WP2	13,5	49	8	21,5	23	0,005
10	10	6383 10 00WP2	16	57	10,5	25,5	26,5	0,012

6382 Codo igual y desigual con espiga lisa

Pulgadas

Bio-polímero, EPDM

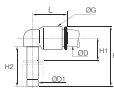

ØD	ØD1		G	H	H1	H2	L	Kg
5/16	3/8	6382 08 60WP2	16	39	10	24,5	26	0,009
1/4	1/4	6382 56 00WP2	11	30,5	11	18	18	0,002
	3/8	6382 56 60WP2	16	39	9	24,5	25,5	0,006
3/8	3/8	6382 60 00WP2	16	39	9	24,5	26,5	0,005
1/2	1/2	6382 62 00WP2	22	49	13	28,5	36	0,004

5/32" (4 mm) y 5/16" (8 mm) también disponible en codo igual.

Las referencias en el diámetro de 4 mm y 12 mm no son ranuradas en la versión estándar.

6388 Te igual con espiga lisa central

Bio-polímero, EPDM

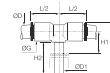

ØD	ØD1		G	H	H1	H2	L/2	Kg
4	4	6388 04 00WP2	8,5	25	6	15,5	15	0,005
6	6	6388 06 00WP2	10,5	28,5	7	17	16	0,006
8	8	6388 08 00WP2	13,5	33,5	8	21,5	23	0,005
10	10	6388 10 00WP2	16	41	9,5	24,5	26,5	0,007

6380 Codo 45° con espiga lisa

Bio-polímero, EPDM

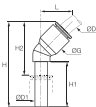

ØD	ØD1		G	H	H1	H2	L	Kg
4	4	6380 04 00WP2	8,5	33,5	19	21	13	0,001
6	6	6380 06 00WP2	11	39	21	25	14,5	0,002
8	8	6380 08 00WP2	13,5	44	21,5	25,5	19,5	0,006
10	10	6380 10 00WP2	16	53	27	32,5	23	0,004
12	12	6380 12 00WP2	19	58	27	34	26	0,012

6388 Te igual con espiga lisa central

Pulgadas

Bio-polímero, EPDM

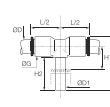

ØD	ØD1		G	H	H1	H2	L/2	Kg
1/4	1/4	6388 56 00WP2	11	30,5	11	20	18	0,002
3/8	3/8	6388 60 00WP2	16	42	12	25	25	0,008

5/32" (4 mm) y 5/16" (8 mm) también disponible.

Para aplicaciones rotativas, recomendamos una versión especial con ranura disponible bajo petición.

Racores instantáneos LIQUIfit® / Racores enclavables



6366 Reductor enclavable

Bio-polímero, EPDM

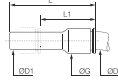

ØD	ØD1		G	L	L1	Kg
4	6	6366 04 06WP2	8,5	38	23,5	0,004
	8	6366 04 08WP2	8,5	38	19	0,004
6	8	6366 06 08WP2	10,5	38	20	0,004
	10	6366 06 10WP2	10,5	39	17,5	0,002
8	10	6366 08 10WP2	13,5	48,5	28,5	0,009
	12	6366 08 12WP2	13,5	48,5	24,5	0,004
10	12	6366 10 12WP2	16	52	33,5	0,005
	14	6366 10 14WP2	16	53	33,5	0,005

6366 Reductor enclavable

Pulgadas

Bio-polímero, EPDM

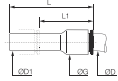

ØD	ØD1		G	L	L1	Kg
1/4	5/16	6366 56 08WP2	11	41	22,5	0,015
	3/8	6366 56 60WP2	11	41	20,5	0,002
3/8	3/8	6366 08 60WP2	13,5	48,5	29	0,003
	1/2	6366 08 62WP2	16	48,5	22	0,007
3/8	1/2	6366 60 62WP2	16	51	30	0,011

6368 Ampliador enclavable

Pulgadas

Bio-polímero, EPDM

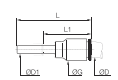

ØD	ØD1		G	L	L1	Kg
3/8	5/16	6368 60 08WP2	16	44	25,5	0,004

6326 Tapón enclavable

Bio-polímero

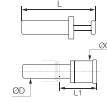

ØD		G	L	L1	Kg
4	6326 04 00WP2	6	30	15,5	0,002
6	6326 06 00WP2	8	33	16,5	0,002
8	6326 08 00WP2	10	35	17,5	0,002
10	6326 10 00WP2	12	42	21	0,003
12	6326 12 00WP2	14	45	22	0,004

6326 Tapón enclavable

Pulgadas

Bio-polímero

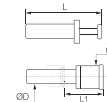

ØD		G	L	L1	Kg
1/4	6326 56 00WP2	8	36,5	22	0,002
3/8	6326 60 00WP2	11,6	42,5	22	0,002
1/2	6326 62 00WP2	14,7	48,5	21,5	0,004

5/32"(4 mm) y 5/16"(8 mm) también disponible.

6322 Espiga acanalada enclavable

Bio-polímero

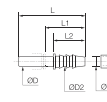

ØD	ØD1	ØD2		L	L1	L2	Kg
6	4	6	6322 06 04WP2	39	25	17	0,004
8	6	8	6322 08 06WP2	43	25	17	0,005
10	7	9	6322 10 07WP2	50	29,5	22	0,006
12	12,5	15,5	6322 12 62WP2	56	32	27,5	0,004

6322 Espiga acanalada enclavable

Pulgadas

Bio-polímero

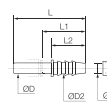

ØD	ØD1	ØD2		L	L1	L2	Kg
1/4	0,28	0,32	6322 56 56WP2	39	24,5	17	0,001
	0,33	0,38	6322 60 08WP2	50	29,5	22	0,002
3/8	0,28	0,32	6322 60 56WP2	45	24,5	17	0,008
	0,40	0,45	6322 60 60WP2	50	29	22	0,002
1/2	0,40	0,45	6322 62 60WP2	58	37,5	30	0,005

Racores instantáneos LIQUIfit® / Accesorios enclavables

6351 Tapón extremo de línea

Bio-polímero, EPDM



ØD		G	H	Kg
4	6351 04 00WP2	8,5	15	0,001
6	6351 06 00WP2	10,5	17	0,002
8	6351 08 00WP2	13,5	21,5	0,003
10	6351 10 00WP2	16	22	0,003
12	6351 12 00WP2	19	27,5	0,006

6351 Tapón extremo de línea

Pulgadas

Bio-polímero, EPDM



ØD		G	H	Kg
1/4	6351 56 00WP2	11	16	0,001
3/8	6351 60 00WP2	16	22,5	0,003

5/32"(4 mm) y 5/16"(8 mm) también disponible.

6986 Tapón enclavable

Acero inox 316L

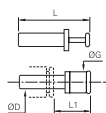

	6986 16 00			
--	-------------------	--	--	--

Adecuado hasta +150°C

Racores instantáneos LIQUIfit® con roscas metal



Fabricada en latón niquelado o acero inoxidable, la base metálica refuerza la instalación del racor.

Ø métrico:
4 a 16 mm

Características técnicas

- Fluidos adecuados:** Agua, bebidas, fluidos industriales: roscas en acero inoxidable 316L
Fluidos industriales: roscas en latón niquelado químico FDA
- Presión de trabajo:** De vacío hasta 16 bar
- Temperatura de trabajo:** -10°C a +130°C (hasta 10 bar) para O.D. 4, 6, 8 mm
-10°C a +95°C para todos otros productos

Par de apriete máx. (BSPP)	Roscas	M5 X0,8	G1/8	G1/4	G3/8	G1/2
	daN.m		0,16	0,8	1,2	3

Las prestaciones dependen de los fluidos, del material y del tubo utilizados. El uso está garantizado para un vacío de 755 mm Hg (99% de vacío).

Ventajas

- Aumento de la resistencia mecánica al apriete
- Compatibilidad con las normas FDA y NSF en versión de acero inoxidable
- Resistencia química y mecánica, a altas temperaturas (hasta 130°C)

Reglamentaciones

- RoHS
- REACH
- FDA: 21 CFR
- 1935/2004
- DM 174
- ACS
- WRAS
- KTW (sólo acero inoxidable)
- W270 (sólo acero inoxidable)

Materiales

Sin silicóna

Cuerpo: polímero de origen ecológico

Base: Inox 316L o latón niquelado químico FDA

Botón pulsador: polímero técnico

Arandela: acero inoxidable

Junta: EPDM

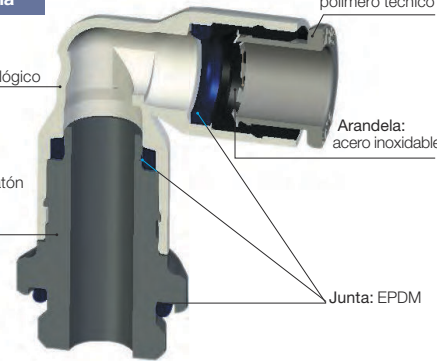

Prestaciones

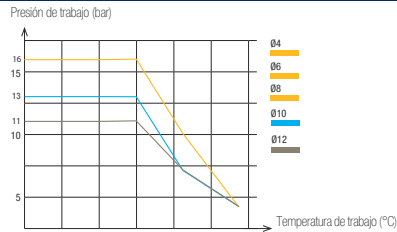

6911 Racor de entrada recto, rosca macho BSPP y métrica

Acero inox 316L, EPDM

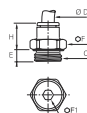

ØD	C		E	F	F1	H	Kg
4	M5x0,8	6911 04 19	3	10	2,5	14	0,006
	G1/8	6911 04 10	4,5	13	3	11,5	0,007
	G1/4	6911 04 13	5,5	16	3	10,5	0,011
6	M5x0,8	6911 06 19	3	11	2,5	16	0,005
	G1/8	6911 06 10	4,5	13	4	13	0,007
	G1/4	6911 06 13	5,5	16	4	12,5	0,011
8	G1/8	6911 08 10	4,5	13	5	20,5	0,011
	G1/4	6911 08 13	5,5	16	6	19,5	0,016
	G3/8	6911 08 17	5,5	21	6	18	0,022
10	G1/4	6911 10 13	5,5	16	7	23	0,018
	G3/8	6911 10 17	5,5	21	8	19,5	0,021
	G1/2	6911 10 21	7	24	8	18	0,033
12	G3/8	6911 12 17	5,5	21	9	27	0,029
	G1/2	6911 12 21	7	24	10	22,5	0,035
	G3/8	6911 16 17	7,5	27	9	32,5	0,060
16	G1/2	6911 16 21	9	27	12	32,5	0,063
	G3/4	6911 16 27	7,5	32	12	32,5	0,096

6975 Racor de entrada recto, rosca macho BSPT

Acero inox 316L, EPDM

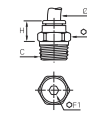

ØD	C		F	F1	H	Kg
4	R1/8	6975 04 10	10	3	9,5	0,005
	R1/4	6975 04 13	14	3	6,5	0,012
6	R1/8	6975 06 10	10	4	11,5	0,005
	R1/4	6975 06 13	14	4	8,5	0,011
8	R1/8	6975 08 10	13	5	20	0,011
	R1/4	6975 08 13	14	6	17	0,014
10	R3/8	6975 08 17	17	6	13	0,021
	R1/4	6975 10 13	16	7	20	0,017
12	R3/8	6975 10 17	17	8	16,5	0,019
	R1/2	6975 10 21	21	8	14	0,037
16	R3/8	6975 12 17	19	9	24	0,028
	R1/2	6975 12 21	21	10	19,5	0,036

Racores instantáneos LIQUIfit® con rosca en acero inoxidable

6959 Codo, rosca macho, BSPP y métrica

Bio-polímero, Acero inox 316L, EPDM

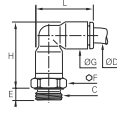

ØD	C		E	F	G	H	L	Kg
4	M5x0,8	6959 04 19	3,5	10	8,5	23	19	0,009
	G1/8	6959 04 10	4,5	13	8,5	22,5	19	0,009
	G1/4	6959 04 13	5,5	16	8,5	22,5	19	0,014
6	M5x0,8	6959 06 19	3,5	10	10,5	26,5	22,5	0,008
	G1/8	6959 06 10	4,5	13	10,5	26,5	22,5	0,011
	G1/4	6959 06 13	5,5	16	10,5	26,5	22,5	0,016
8	G1/8	6959 08 10	4,5	13	13,5	35	29,5	0,018
	G1/4	6959 08 13	5,5	16	13,5	33	29,5	0,020
	G3/8	6959 08 17	5,5	21	13,5	33	29,5	0,028
10	G1/4	6959 10 13	5,5	16	16	40,5	34	0,029
	G3/8	6959 10 17	5,5	21	16	39	34	0,037
	G1/2	6959 10 21	7	24	16	39	34	0,042
12	G1/4	6959 12 13	5,5	19	19	44	40	0,042
	G3/8	6959 12 17	5,5	21	19	42	40	0,040
	G1/2	6959 12 21	7	24	19	42	40	0,049
16	G3/8	6959 16 17	7,5	27	27	54	52	0,088
	G1/2	6959 16 21	9	27	27	55	52	0,084
	G3/4	6959 16 27	10,5	32	27	55	52	0,120

Racor orientable.

6979 Codo, rosca macho BSPT

Bio-polímero, Acero inox 316L, EPDM

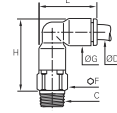

ØD	C		F	G	H	L	Kg
4	R1/8	6979 04 10	10	8,5	23	19	0,008
	R1/4	6979 04 13	14	8,5	23,5	19	0,018
6	R1/8	6979 06 10	10	10,5	27	22,5	0,010
	R1/4	6979 06 13	14	10,5	27,5	22,5	0,020
8	R1/8	6979 08 10	13	13,5	33,5	29,5	0,018
	R1/4	6979 08 13	14	13,5	32,5	29,5	0,022
10	R3/8	6979 08 17	17	13,5	33	29,5	0,032
	R1/4	6979 10 13	15	16	39,5	34	0,031
12	R3/8	6979 10 17	17	16	39,5	34	0,041
	R1/2	6979 10 21	21	16	39,5	34	0,060
16	R3/8	6979 12 17	19	19	45,5	40,5	0,051
	R1/2	6979 12 21	21	19	45,5	40,5	0,065

Racor orientable

6974 Racor de entrada recto, rosca hembra BSPP

Acero inox 316L, EPDM

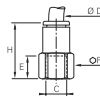

ØD	C		E	F	H	Kg
G3/8	6974 16 17		17	27	44	0,060
16	G1/2	6974 16 21	21,5	27	17	0,065
	G3/4	6974 16 27	19	32	47	0,097

6958 Te, rosca macho central BSPP y métrica

Bio-polímero, Acero inox 316L, EPDM

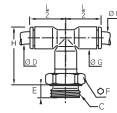

ØD	C		E	F	G	H	L/2	Kg
4	G1/8	6958 04 10	5	13	8,5	22	14	0,009
	G1/4	6958 04 13	5,5	16	8,5	22	14	0,014
6	G1/8	6958 06 10	5	13	10,5	28,5	16	0,011
	G1/4	6958 06 13	5,5	16	10,5	28,5	16	0,016
8	G1/8	6958 08 10	4,5	13	13,5	38	23	0,019
	G3/8	6958 08 17	5,5	21	13,5	36	23	0,030
10	G1/4	6958 10 13	5,5	16	16	43	26,5	0,032
	G3/8	6958 10 17	5,5	21	16	43	26,5	0,055
12	G1/2	6958 10 21	7,5	24	16	43	26,5	0,051
	G3/8	6958 12 17	5,5	21	19	45,5	31	0,042
16	G1/2	6958 12 21	7	24	19	45,5	31	0,049

Racor orientable

Racores instantáneos LIQUIfit® con rosca en acero inoxidable

6978 Te, rosca macho central BSPT

Bio-polímero, Acero inox 316L, EPDM

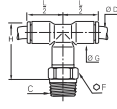

ØD	C		F	G	H	L/2	Kg
4	R1/8	6978 04 10	10	8,5	17	14	0,009
	R1/4	6978 04 13	14	8,5	17	14	0,020
6	R1/8	6978 06 10	10	10,5	23	16	0,011
	R1/4	6978 06 13	14	10,5	23	16	0,011
8	R1/8	6978 08 10	13	13,5	30	23	0,020
	R1/4	6978 08 13	14	13,5	30	23	0,025
8	R3/8	6978 08 17	17	13,5	30	23	0,036
	R1/4	6978 10 13	15	16	34,5	26,5	0,033
10	R3/8	6978 10 17	17	16	34,5	26,5	0,043
	R1/2	6978 10 21	21	16	34,5	26,5	0,065
12	R3/8	6978 12 17	19	19	40,5	31	0,053
	R1/2	6978 12 21	21	19	40,5	31	0,061

6973 Te, rosca macho lateral BSPT

Bio-polímero, Acero inox 316L, EPDM

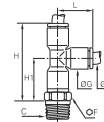

ØD	C		F	G	H	H1	L	Kg
4	R1/8	6973 04 10	10	8,5	31	18	14,5	0,009
	R1/4	6973 04 13	14	8,5	31	19	14,5	0,020
6	R1/8	6973 06 10	10	10,5	38	22	17,5	0,011
	R1/4	6973 06 13	14	10,5	39	23	17,5	0,011
8	R1/8	6973 08 10	13	13,5	53	30	23	0,020
	R1/4	6973 08 13	14	13,5	52	29	23	0,025
8	R3/8	6973 08 17	17	13,5	52	29	23	0,036
	R1/4	6973 10 13	15	16	61	35	26,5	0,033
10	R3/8	6973 10 17	17	16	61	35	26,5	0,043
	R1/2	6973 10 21	21	16	61	35	26,5	0,065
12	R3/8	6973 12 17	19	19	70	39	31	0,053
	R1/2	6973 12 21	21	19	70	39	31	0,061

6953 Te, rosca macho lateral BSPP y métrica

Bio-polímero, Acero inox 316L, EPDM

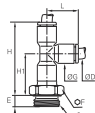

ØD	C		E	F	G	H	H1	L	Kg
4	G1/8	6953 04 10	5	13	8,5	30	18	14,5	0,009
	G1/4	6953 04 13	5,5	16	8,5	30	18	14,5	0,014
6	G1/8	6953 06 10	5	13	10,5	38	22	17,5	0,011
	G1/4	6953 06 13	5,5	16	10,5	38	22	17,5	0,016
8	G1/4	6953 08 13	5,5	16	13,5	52	29	23	0,022
	G3/8	6953 08 17	5,5	21	13,5	52	29	23	0,030
10	G1/4	6953 10 13	5,5	16	16	61	35	26,5	0,032
	G3/8	6953 10 17	5,5	21	16	61	35	26,5	0,055
10	G1/2	6953 10 21	7,5	24	16	61	35	26,5	0,051
	G3/8	6953 12 17	5,5	21	19	67	36	31	0,042
12	G1/2	6953 12 21	7	24	19	67	36	31	0,049

Otros productos de la gama LIQUIfit® con roscas metal

Tubos técnicos

Tubo PE

FEP

PFA



Racores instantáneos LIQUIfit® con rosca en latón niquelado FDA

6901 Racor de entrada recto, rosca macho BSPP y métrica

Latón niquelado químico FDA, EPDM

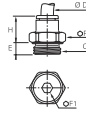

ØD	C		E	F	F1	H	Kg
4	M5x0,8	6901 04 19	3	8	2,5	14	0,003
	G1/8	6901 04 10	5,5	13	3	11,5	0,007
	G1/4	6901 04 13	5,5	16	3	10,5	0,011
6	M5x0,8	6901 06 19	3	11	2,5	16	0,005
	G1/8	6901 06 10	4,5	13	4	13	0,007
	G1/4	6901 06 13	5,5	16	4	12,5	0,011
8	G1/8	6901 08 10	4,5	13	5	20,5	0,011
	G1/4	6901 08 13	5,5	16	6	19,5	0,016
	G3/8	6901 08 17	5,5	20	6	18	0,022
	G1/4	6901 10 13	5,5	16	7	23	0,018
10	G3/8	6901 10 17	5,5	20	8	19,5	0,021
	G1/2	6901 10 21	7	24	8	18	0,033
12	G1/2	6901 12 21	7	24	10	22,5	0,035

6999 Codo, rosca macho, BSPP y métrica

Bio-polímero, Latón niquelado químico FDA, EPDM

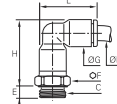

ØD	C		E	F	G	H	L	Kg
4	M5x0,8	6999 04 19	3,5	8	8,5	23	19	0,005
	G1/8	6999 04 10	4,5	13	8,5	22,5	19	0,009
	M5x0,8	6999 06 19	3,5	10	10,5	26,5	22,5	0,008
6	G1/8	6999 06 10	4,5	13	10,5	26,5	22,5	0,011
	G1/4	6999 06 13	5,5	16	10,5	26,5	22,5	0,016
	G1/8	6999 08 10	4,5	13	13,5	35	29,5	0,018
8	G1/4	6999 08 13	5,5	16	13,5	33	29,5	0,020
	G3/8	6999 08 17	5,5	20	13,5	33	29,5	0,028
	G1/4	6999 10 13	5,5	16	16	40,5	34	0,029
10	G3/8	6999 10 17	5,5	20	16	39	34	0,037
	G1/2	6999 10 21	7	24	16	39	34	0,042
12	G3/8	6999 12 17	5,5	20	19	42	40	0,040
	G1/2	6999 12 21	7	24	19	42	40	0,049

Racor orientable

6905 Racor de entrada recto, rosca macho BSPT

Latón niquelado químico FDA, EPDM

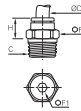

ØD	C		F	F1	H	Kg
4	R1/8	6905 04 10	10	3	9,5	0,005
	R1/4	6905 04 13	14	3	6,5	0,012
6	R1/8	6905 06 10	10	4	11,5	0,005
	R1/4	6905 06 13	14	4	8,5	0,011
	R1/8	6905 08 10	13	5	20	0,011
8	R1/4	6905 08 13	14	6	17	0,014
	R3/8	6905 08 17	17	6	13	0,021
	R1/4	6905 10 13	16	7	20	0,017
10	R3/8	6905 10 17	17	8	16,5	0,019
	R1/2	6905 10 21	21	8	14	0,037
12	R3/8	6905 12 17	19	9	24	0,028
	R1/2	6905 12 21	21	10	19,5	0,036

6909 Codo, rosca macho BSPT

Bio-polímero, Latón niquelado químico FDA, EPDM

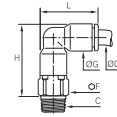

ØD	C		F	G	H	L	Kg
4	R1/8	6909 04 10	10	8,5	23	19	0,008
	R1/4	6909 04 13	14	8,5	23,5	19	0,018
6	R1/8	6909 06 10	10	10,5	27	22,5	0,010
	R1/4	6909 06 13	14	10,5	27,5	22,5	0,020
	R1/8	6909 08 10	13	13,5	33,5	29,5	0,018
8	R1/4	6909 08 13	14	13,5	32,5	29,5	0,022
	R3/8	6909 08 17	17	13,5	33	29,5	0,032
	R1/4	6909 10 13	15	16	39,5	34	0,031
10	R3/8	6909 10 17	17	16	39,5	34	0,041
	R1/2	6909 10 21	21	16	39,5	34	0,060
12	R3/8	6909 12 17	19	19	45,5	40,5	0,051
	R1/2	6909 12 21	21	19	45,5	40,5	0,065

Racor orientable

Racores instantáneos LIQUIfit® con rosca en latón niquelado FDA

6998 Te, rosca macho central BSPP y métrica

Bio-polímero, Latón niquelado químico FDA, EPDM

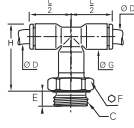

ØD	C		E	F	G	H	L/2	Kg
4	M5x0,8	6998 04 19	3,5	8	8,5	24	14	0,006
	G1/8	6998 04 10	5	13	8,5	22	14	0,009
	G1/4	6998 04 13	5,5	16	8,5	22	14	0,014
6	M5x0,8	6998 06 19	3,5	10	10,5	30	16	0,009
	G1/4	6998 06 13	5,5	16	10,5	29	16	0,016
8	G1/8	6998 08 10	4,5	13	13,5	38	23	0,019
	G1/4	6998 10 13	5,5	16	16	43	26,5	0,032
10	G3/8	6998 10 17	5,5	20	16	43	26,5	0,055
	G1/2	6998 10 21	7,5	24	16	43	26,5	0,051
12	G3/8	6998 12 17	5,5	20	19	45,5	31	0,042
	G1/2	6998 12 21	7	24	19	45,5	31	0,049

Racor orientable.

6993 Te, rosca macho lateral BSPP y métrica

Bio-polímero, Latón niquelado químico FDA, EPDM

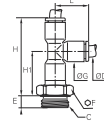

ØD	C		E	F	G	H	H1	L	Kg
4	M5x0,8	6993 04 19	3,5	8	8,5	32	19	14,5	0,006
	G1/8	6993 04 10	5	13	8,5	30	18	14,5	0,009
	G1/4	6993 04 13	5,5	16	8,5	30	18	14,5	0,014
6	M5x0,8	6993 06 19	3,5	10	10,5	39	23	17,5	0,009
	G1/4	6993 06 13	5,5	16	10,5	38	22	17,5	0,016
8	G1/8	6993 08 10	4,5	13	13,5	54	31	23	0,019
	G3/8	6993 08 17	5,5	20	13,5	52	29	23	0,030
10	G3/8	6993 10 17	5,5	20	16	61	35	26,5	0,055
	G1/2	6993 10 21	7,5	24	16	61	35	26,5	0,051
12	G3/8	6993 12 17	5,5	20	19	67	36	31	0,042
	G1/2	6993 12 21	7	24	19	67	36	31	0,049

Racor orientable.

6908 Te, rosca macho central BSPT

Bio-polímero, Latón niquelado químico FDA, EPDM

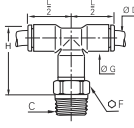

ØD	C		F	G	H	L/2	Kg
4	R1/8	6908 04 10	10	8,5	17	14	0,009
	R1/4	6908 04 13	14	8,5	17	14	0,020
6	R1/4	6908 06 13	14	10,5	23	16	0,011
	R1/8	6908 08 10	13	13,5	30	23	0,020
8	R1/4	6908 08 13	14	13,5	30	23	0,025
	R3/8	6908 08 17	17	13,5	30	23	0,036
10	R1/4	6908 10 13	15	16	34,5	26,5	0,033
	R3/8	6908 10 17	17	16	34,5	26,5	0,043
12	R1/2	6908 10 21	21	16	34,5	26,5	0,065
	R3/8	6908 12 17	19	19	40,5	31	0,053
	R1/2	6908 12 21	21	19	40,5	31	0,061

Racor orientable.

6903 Te, rosca macho lateral BSPT

Bio-polímero, Latón niquelado químico FDA, EPDM

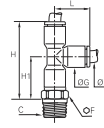

ØD	C		F	G	H	H1	L	Kg
4	R1/8	6903 04 10	10	8,5	31	18	14,5	0,009
	R1/4	6903 04 13	14	8,5	31	19	14,5	0,020
6	R1/4	6903 06 13	14	10,5	39	23	17,5	0,011
	R1/8	6903 08 10	13	13,5	53	30	23	0,020
8	R1/4	6903 08 13	14	13,5	52	29	23	0,025
	R3/8	6903 08 17	17	13,5	52	29	23	0,036
10	R1/4	6903 10 13	15	16	61	35	26,5	0,033
	R3/8	6903 10 17	17	16	61	35	26,5	0,043
12	R1/2	6903 10 21	21	16	61	35	26,5	0,065
	R3/8	6903 12 17	19	19	70	39	31	0,053
	R1/2	6903 12 21	21	19	70	39	31	0,061

Racor orientable.

Racores instantáneos LF 3600 / Racores de implantación



Fabricada en latón niquelado químico, esta gama de accesorios metálicos es resistente a los fluidos industriales y alimentarios.

Ø métrico:
4 a 14 mm

Características técnicas

- **Fluidos adecuados:** Aire comprimido, grasa, lubricante, agua, ...
- **Presión de trabajo:** De vacío hasta 30 bar (20 bar: 3699, 3609, 3639)
- **Temperatura de trabajo:** -25°C a +150°C

Par de apriete máximo (daN.m)	Rosca							
	M5 x0,8	M6 x1	M8 x1	M10 x1	G1/8	G1/4	G3/8	G1/2
	0,16	0,18	0,6	0,8	0,8	1,2	3	3,5

Las prestaciones dependen de los fluidos, del material y del tubo utilizados. El uso está garantizado para un vacío de 755 mm Hg (99% de vacío).

Ventajas

- Amplio rango de temperaturas de trabajo: hasta +150°C
- Amplia gama de presiones de trabajo: desde el vacío hasta 30 bar
- Los materiales se ajustan a las normas de la FDA
- Compatibilidad química ampliada

Materiales

Sin silicona

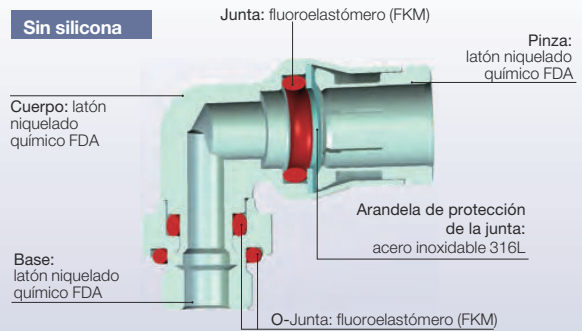

Reglamentaciones

- PED
- RoHS
- REACH

3675 Racor de entrada recto, rosca macho BSPP

Latón niquelado químico FDA, FKM

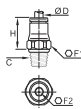

ØD	C		F1	F2	H	Kg
4	R1/8	3675 04 10	10	3	15	0,009
	R1/4	3675 04 13	14	3	15	0,017
6	R1/8	3675 06 10	13	4	17	0,011
	R1/4	3675 06 13	14	4	17	0,018
8	R1/8	3675 08 10	15	5	19	0,015
	R1/4	3675 08 13	16	6	18	0,019
10	R3/8	3675 08 17	17	6	18,5	0,027
	R1/4	3675 10 13	18	7	23	0,026
12	R3/8	3675 10 17	18	8	22,5	0,031
	R1/2	3675 10 21	22	8	22,5	0,056
14	R1/4	3675 12 13	20	7	25,5	0,033
	R3/8	3675 12 17	20	9	24	0,035
16	R1/2	3675 12 21	22	10	23	0,051
	R3/8	3675 14 17	22	9	27	0,042
18	R1/2	3675 14 21	24	11	26	0,057

3601 Racor de entrada recto, rosca macho BSPP y métrica

Latón niquelado químico FDA, FKM

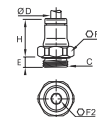

ØD	C		E	F1	F2	H	Kg
4	M5x0,8	3601 04 19	3,5	10	2,5	15,5	0,006
	M6x1	3601 04 52	4,5	10	3	16	0,006
6	M8x1	3601 04 56	5	11	3	14,5	0,007
	G1/8	3601 04 10	5,5	13	3	14,5	0,009
8	G1/4	3601 04 13	6,5	16	3	14,5	0,015
	M5x0,8	3601 06 19	3,5	13	2,5	19	0,010
10	M10x1	3601 06 60	5,5	13	4	17,5	0,011
	G1/8	3601 06 10	5,5	13	4	17,5	0,011
12	G1/4	3601 06 13	6,5	16	4	17	0,015
	G1/8	3601 08 10	5,5	16	5	21	0,014
14	G1/4	3601 08 13	6,5	16	6	18	0,016
	G3/8	3601 08 17	7,5	20	6	19	0,028
16	G1/4	3601 10 13	6,5	18	7	25	0,025
	G3/8	3601 10 17	7,5	20	8	22,5	0,028
18	G1/2	3601 10 21	9	24	8	22,5	0,043
	G1/4	3601 12 13	6,5	20	7	26,5	0,030
20	G3/8	3601 12 17	7,5	20	9	26	0,034
	G1/2	3601 12 21	9	24	10	23,5	0,042
22	G3/8	3601 14 17	7,5	22	9	28	0,038
	G1/2	3601 14 21	9	24	11	26,5	0,045

Racores instantáneos LF 3600 / Racores de implantación

3681 Racor de entrada recto hexagonal interior, rosca macho métrica

Latón niquelado químico FDA, FKM

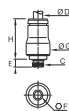

ØD	C	E	F	G	H	Kg
4	M5x0,8	3,5	2,5	10	16	0,005

3614 Racor de entrada recto, rosca hembra BSPP y métrica

Latón niquelado químico FDA, FKM

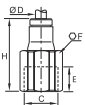

ØD	C	E	F	H	Kg
	M5x0,8	5	10	22	0,009
4	G1/8	7,5	14	25	0,016
	G1/4	11	17	29	0,026
6	G1/8	7,5	14	27,5	0,019
	G1/4	11	17	31,5	0,028
8	G1/8	9,5	15	28,5	0,022
	G1/4	13,5	17	32,5	0,028
10	G3/8	14	22	38	0,052
12	G3/8	14	22	39	0,055
	G1/2	18,5	24	43,5	0,062

3621 Adaptador enclavable, rosca macho BSPT

Latón niquelado químico FDA

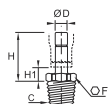

ØD	C	F	H	H1	Kg
4	R1/8	10	21	7	0,006
	R1/8	10	23,5	6,5	0,008
6	R1/4	14	23,5	6,5	0,016
	R1/8	10	24	6,5	0,009
8	R1/4	14	24	6,5	0,017
	R1/4	14	22	6,5	0,018
10	R3/8	17	30	7,5	0,022
	R3/8	17	31	7,5	0,023
12	R1/2	22	31	7,5	0,041
	R1/2	22	33	8	0,042

3631 Adaptador, rosca macho BSPP y métrica

Latón niquelado químico FDA, FKM

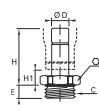

ØD	C	E	F	H	H1	Kg
	M5x0,8	3,5	13	21,5	7	0,003
4	G1/8	5,5	13	20	7	0,007
	G1/4	6,5	8	20	7,5	0,011
6	G1/8	5,5	13	22,5	6,5	0,009
	G1/4	6,5	16	22,5	6,5	0,012
8	G1/8	5,5	13	22,5	6,5	0,010
	G1/4	6,5	16	23	7,5	0,018
10	G3/8	7,5	20	23	7,5	0,018
	G1/2	9	24	28	7,5	0,028
12	G3/8	7,5	20	29	7,5	0,023
	G1/2	9	24	29	7,5	0,033
14	G1/2	9	24	31	8	0,033

3600 Cartucho monobloque

Latón niquelado químico FDA, FKM

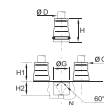

ØD	G	G1	H	H1	H2	N	Kg
4	9,8	8	17	8,5	8,5	11	0,006
6	12,1	10	19	10,5	8,5	13,5	0,009
8	14,8	13	21	12,5	8,5	16	0,012
10	17,5	15	24,5	14	10,5	20	0,019
12	20	17	25	14,5	10,5	22,5	0,023
14	22	20	28,5	16,5	12	25	0,031

Tamaño de la cavidad disponible a petición

3609 Codo, rosca macho BSPT

Latón niquelado químico FDA, FKM

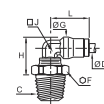

ØD	C	F	G	H	J	L	Kg
4	R1/8	13	10	15	7	18	0,014
	R1/4	14	10	17	7	18	0,020
6	R1/8	13	12	17,5	8	21,5	0,018
	R1/4	14	12	19	8	21,5	0,025
8	R1/8	13	15	19,5	10	23,5	0,022
	R1/4	14	15	21	10	23,5	0,029
10	R3/8	17	15	21	10	23,5	0,035
	R1/4	15	17,5	23,5	12	29	0,037
12	R3/8	17	17,5	25,5	12	29	0,043
	R1/4	15	19,5	26	15	31	0,049
14	R3/8	17	19,5	28,5	15	31	0,055
	R1/2	21	19,5	28,5	15	31	0,072
14	R3/8	19	21,5	29	16	34	0,063
	R1/2	22	21,5	30	16	34	0,072

Racor orientable. Presión máxima = 20 bar

Racores instantáneos LF 3600 / Racores de implantación

3629 Codo elevado, rosca macho BSPT

Latón niquelado químico FDA, FKM



ØD	C		F	G	H	J	L	Kg
4	R1/8	3629 04 10	10	10	24,5	7	18	0,025
6	R1/8	3629 06 10	13	12	29,5	8	21,5	0,024
	R1/4	3629 06 13	14	12	30,5	8	21,5	0,031
8	R1/8	3629 08 10	14	15	32,5	10	23,5	0,031
	R1/4	3629 08 13	14	15	34	10	23,5	0,037
10	R1/4	3629 10 13	18	17,5	39	12	29	0,054

Racor orientable.

3669 Codo compacto, rosca macho BSPP y métrica

Latón niquelado químico FDA, FKM

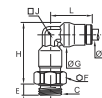

ØD	C		E	F	G	H	J	L	Kg
4	M5x0,8	3669 04 19	3,5	10	10	27,5	7	18	0,014
	G1/8	3669 04 10	5,5	13	10	25,5	7	18	0,017
6	G1/8	3669 06 10	5,5	13	12	31	8	21,5	0,024
	G1/4	3669 06 13	6,5	16	12	30,5	8	21,5	0,028
8	G1/8	3669 08 10	5,5	14	15	33,5	10	23,5	0,031
	G1/4	3669 08 13	5,5	16	15	34	10	23,5	0,035
10	G1/4	3669 10 13	6,5	18	17,5	42	12	29	0,052
	G3/8	3669 10 17	7,5	20	17,5	41	12	29	0,056
12	G1/4	3669 12 13	6,5	20	19,5	47	15	31	0,070
	G3/8	3669 12 17	7,5	20	19,5	46	15	31	0,341
14	G1/2	3669 14 21	9	24	21,5	49	16	34	0,094

Racor orientable.

3699 Codo compacto, rosca macho BSPP y métrica

Latón niquelado químico FDA, FKM

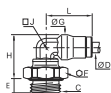

ØD	C		E	F	G	H	J	L	Kg
4	M5x0,8	3699 04 19	3,5	10	10	18	7	18	0,011
	M6x1	3699 04 52	4,5	10	10	18	7	18	0,011
	M8x1	3699 04 56	5	11	10	18	7	18	0,013
	G1/8	3699 04 10	5,5	13	10	17	7	18	0,014
	G1/4	3699 04 13	6,5	16	10	17,5	7	18	0,019
	M10x1	3699 06 60	5,5	13	12	19	8	21,5	0,017
	6	G1/8	3699 06 10	5,5	13	12	19	8	21,5
G1/4		3699 06 13	6,5	16	12	19,5	8	21,5	0,022
G1/8		3699 08 10	5,5	13	15	20,5	10	23,5	0,021
8	G1/4	3699 08 13	6,5	16	15	21,5	10	23,5	0,027
	G3/8	3699 08 17	7,5	20	15	21,5	10	23,5	0,033
	G1/4	3699 10 13	6,5	16	17,5	27	12	29	0,037
10	G3/8	3699 10 17	7,5	20	17,5	25,5	12	29	0,043
	G1/4	3699 12 13	6,5	16	19,5	29,5	15	31	0,050
12	G3/8	3699 12 17	7,5	20	19,5	28,5	15	31	0,057
	G1/2	3699 12 21	9	24	19,5	28,5	15	31	0,065
14	G3/8	3699 14 17	7,5	20	21,5	29	16	34	0,059
	G1/2	3699 14 21	9	24	21,5	29,5	16	34	0,062

Racor orientable. Presión máxima = 20 bar

3608 Te, rosca macho central BSPT

Latón niquelado químico FDA, FKM

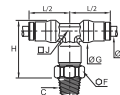

ØD	C		F	G	H	J	L/2	Kg
4	R1/8	3608 04 10	10	10	24,5	7	18	0,020
6	R1/8	3608 06 10	13	12	29,5	8	21,5	0,031
	R1/4	3608 06 13	14	12	30,5	8	21,5	0,038
8	R1/8	3608 08 10	14	15	32,5	10	23,5	0,040
	R1/4	3608 08 13	14	15	34	10	23,5	0,047
10	R1/4	3608 10 13	18	17,5	39	12	29	0,067
	R3/8	3608 10 17	18	17,5	41	12	29	0,070
12	R3/8	3608 12 17	20	19,5	46,5	15	31	0,094
14	R1/2	3608 14 21	22	21,5	50,5	16	34	0,125

Racor orientable.

3603 Te, rosca macho lateral BSPT

Latón niquelado químico FDA, FKM

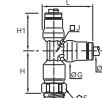

ØD	C		F	G	H	H1	J	L	Kg
4	R1/8	3603 04 10	10	10	19,5	18	7	23	0,018
	R1/8	3603 06 10	13	12	23,5	21,5	8	28	0,031
6	R1/4	3603 06 13	14	12	24,5	21,5	8	28	0,037
	R1/8	3603 08 10	14	15	25	23,5	10	31	0,041
8	R1/4	3603 08 13	14	15	26,5	23,5	10	31	0,044
	R1/4	3603 10 13	18	17,5	30,5	29	12	37,5	0,067
10	R3/8	3603 10 17	18	17,5	32,5	29	12	37,5	0,069
	R3/8	3603 12 17	20	19,5	36,5	31	15	40,5	0,103
14	R1/2	3603 14 21	22	21,5	40	34	16	45	0,147

Racor orientable.

Racores instantáneos LF 3600 / Racores de implantación



3698 Te, rosca macho central BSPP y métrica

Latón niquelado químico FDA, FKM

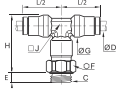

ØD	C		E	F	G	H	J	L/2	Kg
4	M5x0,8	3698 04 19	3,5	10	10	27,5	7	18	0,018
	G1/8	3698 04 10	5,5	13	10	25,5	7	18	0,021
6	G1/8	3698 06 10	5,5	13	12	31	8	21,5	0,031
	G1/4	3698 06 13	6,5	16	12	30,5	8	21,5	0,035
8	G1/8	3698 08 10	5,5	14	15	33,5	10	23,5	0,041
	G1/4	3698 08 13	6,5	16	15	34	10	23,5	0,045
10	G1/4	3698 10 13	6,5	18	17,5	42	12	29	0,066
12	G3/8	3698 12 17	7,5	20	19,5	46	15	31	0,088
14	G1/2	3698 14 21	9	24	21,5	49	16	34	0,119

Racor orientable.

3693 Te, rosca macho lateral BSPP y métrica

Latón niquelado químico FDA, FKM

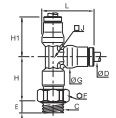

ØD	C		E	F	G	H	H1	J	L	Kg
4	M5x0,8	3693 04 19	3,5	10	10	22,5	18	7	23	0,019
	G1/8	3693 04 10	5,5	13	10	20,5	18	7	23	0,021
6	G1/8	3693 06 10	5,5	13	12	25	21,5	8	28	0,031
	G1/4	3693 06 13	6,5	16	12	24,5	21,5	8	28	0,035
8	G1/8	3693 08 10	5,5	14	15	26,5	23,5	10	31	0,041
	G1/4	3693 08 13	6,5	16	15	26,5	23,5	10	31	0,044
10	G1/4	3693 10 13	6,5	18	17,5	33	29	12	37,5	0,066
12	G3/8	3693 12 17	7,5	20	19,5	36,5	31	15	40,5	0,090
14	G1/2	3693 14 21	9	24	21,5	38,5	34	16	45	0,112

Racor orientable.

3618 Banjo simple, rosca macho BSPP y métrica

Latón niquelado químico FDA, FKM

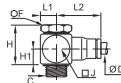

ØD	C		F	H	H1	J	L1	L2	Kg
4	M5x0,8	3618 04 19	8	13	6	10	6	18,5	0,011
	G1/8	3618 04 10	13	16,5	7	15	7,5	22	0,029
6	M5x0,8	3618 06 19	8	13	6	10	5	22,5	0,015
	G1/8	3618 06 10	13	16,5	7	15	7,5	24	0,031
8	G1/4	3618 06 13	17	21	9	18	9	24	0,049
	G1/8	3618 08 10	13	16,5	7	15	7,5	25,5	0,033
10	G1/4	3618 08 13	17	21	9	18	9	26,5	0,051
	G3/8	3618 10 17	20	24,5	11	21,5	11	33	0,105

Temperatura máxima : +80°C

Racores instantáneos LF 3600 / Racores de implantación

3606 Unión igual

Latón niquelado químico FDA, FKM

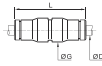

ØD		G	L	Kg
4	3606 04 00	10	30,5	0,010
6	3606 06 00	12	36,5	0,016
8	3606 08 00	15	37,5	0,021
10	3606 10 00	17,5	47,5	0,034
12	3606 12 00	19,5	50	0,042
14	3606 14 00	21,5	52,5	0,050

3602 Codo igual

Latón niquelado químico FDA, FKM

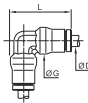

ØD		G	L	Kg
4	3602 04 00	10	23	0,010
6	3602 06 00	12	28	0,016
8	3602 08 00	15	31	0,022
10	3602 10 00	17,5	37,5	0,033
12	3602 12 00	19,5	40,5	0,045
14	3602 14 00	21,5	45	0,056

3604 Te igual

Latón niquelado químico FDA, FKM

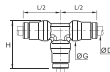

ØD		G	H	L/2	Kg
4	3604 04 00	10	23	18	0,014
6	3604 06 00	12	28	21,5	0,023
8	3604 08 00	15	31	23,5	0,032
10	3604 10 00	17,5	37,5	29	0,048
12	3604 12 00	19,5	40,5	31	0,063
14	3604 14 00	21,5	45	34	0,078

Racores instantáneos LF 3600 / Racores pasatabiques



3616 Unión igual pasatabiques

Latón niquelado químico FDA, FKM

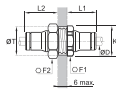

ØD		F1	F2	K	L1	L2	ØT min	Kg
4	3616 04 00	13	14	14	14	20	12,5	0,018
6	3616 06 00	16	17	17,5	17	22	15	0,028
8	3616 08 00	18	19	19,5	18,5	23,5	17	0,036
10	3616 10 00	22	27	24	21,5	26,5	21	0,063
12	3616 12 00	24	24	26	23	27	23	0,062
14	3616 14 00	27	27	29,5	25,5	29,5	25	0,079

3636 Unión pasatabiques, rosca hembra BSPP

Latón niquelado químico FDA, FKM

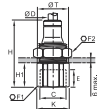

ØD	C		E	F1	F2	H	H1	K	ØT min	Kg
4	G1/8	3636 04 10	8,5	14	14	30,5	11	15	13	0,020
6	G1/8	3636 06 10	8,5	17	17	33	11	18,5	15	0,033
	G1/4	3636 06 13	11,5	17	17	37	15	18,5	15	0,033
8	G1/8	3636 08 10	8,5	19	19	34	10,5	21	17	0,044
	G1/4	3636 08 13	11,5	19	19	38	14,5	21	17	0,044
10	G3/8	3636 10 17	12	22	27	42,5	16	24	21	0,073
	G3/8	3636 12 17	12	24	24	43	16	26	23	0,077
12	G1/2	3636 12 21	16	27	24	48,5	21,5	29,5	23	0,133

3639 Codo igual pasatabiques

Latón niquelado químico FDA, FKM

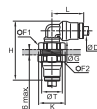

ØD		F1	F2	G	H	K	L	ØT min	Kg
4	3639 04 00	13	14	10	35	14	18	12,5	0,023
6	3639 06 00	16	17	12	40,5	17,5	21,5	15	0,035
8	3639 08 00	18	19	15	44	19,5	23,5	17	0,046
10	3639 10 00	22	27	17,5	51	24	29	21	0,080
12	3639 12 00	24	24	19,5	55	26	31	23	0,086
14	3639 14 00	27	27	21,5	59	29,5	34	25	0,144

Racor orientable.
Presión máxima = 20 bar

Racores instantáneos LF 3600 / Accesorios enclavables

3666 Reductor enclavable

Latón niquelado químico FDA, FKM



ØD1	ØD2		G	L	L1	L2	Kg
4	6	3666 04 06	10	35	19,5	18	0,008
	8	3666 04 08	10	35,5	20	18	0,009
6	8	3666 06 08	12	38	20	20,5	0,012
	10	3666 06 10	12	43,5	25	21	0,015
8	10	3666 08 10	15	44	25	21,5	0,016
	12	3666 08 12	15	44	26	20,5	0,018
10	12	3666 10 12	17,5	50	26	27	0,026
12	14	3666 12 14	19,5	53	28	28,5	0,032

3667 Adaptador enclavable de tubo milimétrico a tubo en pulgadas

Latón niquelado químico FDA, FKM

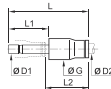

ØD1	ØD2		G	L	L1	L2	Kg
6	1/4	3667 06 56	12,5	38,5	19,5	21	0,012
10	3/8	3667 10 60	17	49,5	25	27	0,026
12	1/2	3667 12 62	20	51	26	27,5	0,030

3668 Ampliador enclavable

Latón niquelado químico FDA, FKM

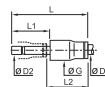

ØD1	ØD2		G	L	L1	L2	Kg
6	4	3668 06 04	12	36	17	21,5	0,010

3622 Espiga acanalada enclavable

Latón niquelado químico FDA

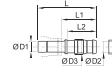

ØD1	ØD2	ØD3		L	L1	L2	Kg
4	3,2	5	3622 04 53	40,5	27	22,5	0,003
	5	7	3622 04 05	40,5	27	22,5	0,005
6	5	7	3622 06 05	43	27	22,5	0,006
8	6,3	8,3	3622 08 56	42	25	22,5	0,008
	8	10	3622 08 08	44	27	22,5	0,010
10	6,3	8,3	3622 10 56	47,5	25,5	22,5	0,011
	8	10	3622 10 08	47,5	25,5	22,5	0,011
12	8	10	3622 12 08	48,5	25,5	22,5	0,015
	10	12	3622 12 10	48,5	25,5	22,5	0,014
14	12,5	14,5	3622 12 62	57	34	29,5	0,019
	12,5	14,5	3622 14 62	57,5	33	29,5	0,022
14	16	3622 14 14	59,5	35	29,5	0,023	

3620 Unión doble macho enclavable

Latón niquelado químico FDA



ØD		L	L1	Kg
4	3620 04 00	31	14	0,002
6	3620 06 00	36,5	17	0,005
8	3620 08 00	37,5	17,5	0,007
10	3620 10 00	47,5	22,5	0,011
12	3620 12 00	49,5	23,5	0,015
14	3620 14 00	53	25	0,016

3626 Unión doble macho enclavable

Latón niquelado químico FDA



ØD		G	L	L1	L2	L3	Kg
4	3626 04 00	6	25,5	17,5	11,5	0,004	
6	3626 06 00	8	30,5	19,5	13,5	0,009	
8	3626 08 00	10	33	20	16	0,009	
10	3626 10 00	12	40	25	18	0,015	
12	3626 12 00	14	43	26	20	0,021	
14	3626 14 00	16	47	28	22,5	0,029	

Racores instantáneos LF 3600 / Kits de mantenimiento



La herramienta esencial para realizar rápidamente las principales operaciones de mantenimiento y reducir las paradas de producción.

Ventajas

- 24 referencias que engloban los productos más comunes
- Productos disponibles en los diámetros más comunes: 4 mm, 6 mm and 8 mm
- Un kit contiene más de 232 productos y puede ser fácilmente completado con nuestros productos estándar

3650..33 Kit de mantenimiento



3650 00 00 33

H	L	L1	Kg
81	413	330	2,900

Racores instantáneos LF 3600 latón sin plomo



Diseñado para aplicaciones que requieren un bajo contenido de plomo en los componentes del circuito.

**Ø métrico:
4 a 8 mm**

Características técnicas

- **Fluidos adecuados:** agua potable y vapor
Otros fluidos: por favor, consúltenos
- **Presión de trabajo:** De vacío hasta 30 bar. Los modelos 3609, 3699 y 3639 están limitados a 20 bar
- **Temperatura de trabajo:** -25°C a +150°C

Par de apriete máxím (daN.m)	Rosca		
	M5x0,8	G1/8	G1/4
	0,06	0,8	1,2

Las prestaciones dependen de los fluidos, del material y del tubo utilizados. El uso está garantizado para un vacío de 755 mm Hg (99% de vacío).

Ventajas

- Oferta especial para máquinas de café y máquinas expendedoras de bebidas
- Productos hechos a medida, según sus especificaciones. Póngase en contacto con nosotros.

Materiales

Sin silicona

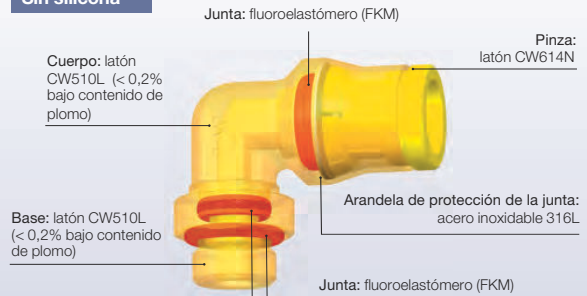

Reglamentaciones

- 1935/2004
- NSF/ANSI 169
- DM 174
- FDA : 21 CFR
- RoHS
- REACH
- EN 16889
- LFGB

3601 Racor de entrada recto, rosca macho métrica cilíndrica BSPP

Latón con bajo contenido de plomo, FKM

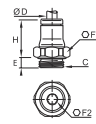

ØD	C		E	F1	F2	H	Kg
4	G1/8	3601 04 10 84	5,5	13	3	14,5	0,009
	G1/4	3601 04 13 84	6,5	16	3	14,5	0,015
	M5x0,8	3601 04 19 84	3,5	10	2,5	15,5	0,006
6	G1/8	3601 06 10 84	5,5	13	4	17,5	0,011
	G1/4	3601 06 13 84	6,5	16	4	17	0,015
8	G1/8	3601 08 10 84	5,5	16	5	21	0,014

3609 Codo, rosca macho BSPT

Latón con bajo contenido de plomo, FKM

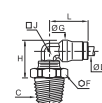

ØD	C		F	G	H	J	L	Kg
4	R1/8	3609 04 10 84	13	10	15	7	18	0,014
	R1/4	3609 04 13 84	14	10	17	7	18	0,020
6	R1/8	3609 06 10 84	13	12	17,5	8	21,5	0,018
	R1/4	3609 06 13 84	14	12	19	8	21,5	0,025

Racor orientable.

3614 Racor de entrada recto, rosca hembra BSPP y métrica

Latón con bajo contenido de plomo, FKM

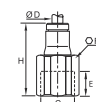

ØD	C		E	F	H	Kg
4	G1/8	3614 04 10 84	7,5	14	25	0,016
	G1/4	3614 04 13 84	11	17	29	0,026
6	G1/8	3614 06 10 84	7,5	14	27,5	0,019
	G1/4	3614 06 13 84	11	17	31,5	0,028

3608 Te, rosca macho lateral BSPT

Latón con bajo contenido de plomo, FKM

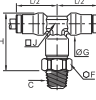

ØD	C		F	G	H	J	L/2	Kg
4	R1/8	3608 04 10 84	10	10	24,5	7	18	0,020

Racor orientable.

Racores instantáneos LF 3600 latón sin plomo



3621 Adaptador, rosca macho BSPT

Latón con bajo contenido de plomo

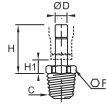

ØD	C	F	H	H1	Kg	
6	R1/8	3621 06 10 84	10	23,5	6,5	0,008

3631 Adaptador, rosca macho BSPP y métrica

Latón con bajo contenido de plomo, FKM

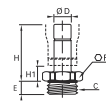

ØD	C	E	F	H	H1	Kg	
8	G1/8	3631 08 10 84	5,5	13	22,5	6,5	0,010

3675 Racor de entrada recto, rosca macho BSPT

Latón con bajo contenido de plomo, FKM

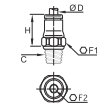

ØD	C	F1	F2	H	Kg	
4	R1/8	3675 04 10 84	10	3	15	0,009
	R1/4	3675 04 13 84	14	3	15	0,017
6	R1/8	3675 06 10 84	13	4	17	0,011

3693 Te, rosca macho lateral BSPP y métrica

Latón con bajo contenido de plomo, FKM

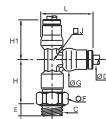

ØD	C	E	F	G	H	H1	J	L	Kg	
4	G1/8	3693 04 10 84	5,5	13	10	20,5	18	7	23	0,021
6	G1/8	3693 06 10 84	5,5	13	12	25	21,5	8	28	0,031

Racor orientable.

3698 Te, rosca macho lateral BSPP y métrica

Latón con bajo contenido de plomo, FKM

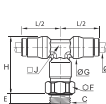

ØD	C	E	F	G	H	J	L/2	Kg	
6	G1/8	3698 06 10 84	5,5	13	12	31	8	21,5	0,031

Racor orientable.

3699 Codo, rosca macho BSPP y métrica

Latón con bajo contenido de plomo, FKM

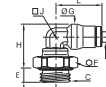

ØD	C	E	F	G	H	J	L	Kg	
	M5x0,8	3699 04 19 84	3,5	10	10	18	7	18	0,011
4	G1/8	3699 04 10 84	5,5	13	10	17,5	7	18	0,014
	G1/4	3699 04 13 84	6,5	16	10	17,5	7	18	0,019
6	G1/8	3699 06 10 84	5,5	13	12	19	8	21,5	0,018
	G1/4	3699 06 13 84	6,5	16	12	19,5	8	21,5	0,022
8	G1/8	3699 08 10 84	5,5	13	15	20,5	10	23,5	0,021

Racor orientable.

3602 Codo igual

Latón con bajo contenido de plomo, FKM



ØD	G	L	Kg	
4	3602 04 00 84	10	23	0,010

3603 Te, rosca macho lateral BSPT

Latón con bajo contenido de plomo, FKM

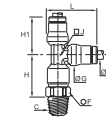

ØD	C	F	G	H	H1	J	L	Kg	
4	R1/8	3603 04 10 84	10	10	19,5	18	7	23	0,018

Racor orientable.

3604 Te igual

Latón con bajo contenido de plomo, FKM

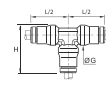

ØD	G	H	L/2	Kg	
4	3604 04 00 84	10	23	18	0,014
6	3604 06 00 84	12	28	21,5	0,023

3639 Codo igual pasatabiques

Latón con bajo contenido de plomo, FKM

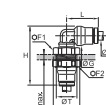

ØD	F1	F2	G	H	K	L	ØT min	Kg	
4	3639 04 00 84	13	14	10	35	14	18	12,5	0,023

Racor orientable.

Racores instantáneos LF 3600 latón sin plomo

3620 Unión doble enclavable

Latón con bajo contenido de plomo



ØD		L	L1	Kg
4	3620 04 00 84	31	14	0,002
6	3620 06 00 84	36,5	17	0,005

3622 Espiga acanalada enclavable

Latón con bajo contenido de plomo

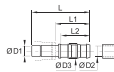

ØD1	ØD2	ØD3		L	L1	L2	Kg
4	3,2	5	3622 04 53 84	40,5	27	22,5	0,003

3626 Tapón enclavable

Latón con bajo contenido de plomo



ØD		G	L	L1	L2	Kg
4	3626 04 00 84	6	25,5	17,5	11,5	0,004

Productos relacionados

- Tubo poliuretano
- Tubo poliamida
- Tubo polietileno
- Tubo fluoropolímero
- Anti-chispas
- PA ignífuga
- Racores reguladores de caudal de latón

Racores instantáneos LF 3800 / Racores de implantación



Fabricada en acero inoxidable 316L, esta gama es adecuada para el transporte de fluidos corrosivos o alimentarios, en ambientes agresivos o para altas exigencias higiénicas.

Ø métrico: 4 a 12 mm
Ø pulgadas: 3/16" a 1/2"

Características técnicas

- **Presión de trabajo:** De vacío hasta 30 bar (20 bar: 3879 y 3889)
- **Presión de trabajo:** -25°C a +150°C
- **Fluidos adecuados:** Todos los fluidos compatibles con los componentes del racor y el tubo utilizado

Par de apriete de bases	Roscas	M5 x0,8	G1/8	G1/4	G3/8	G1/2
	daN.m	0,16	0,8	1,2	3	3,5

Par de apriete de pasatabiques	Ø (mm)	4	6	8	10	12
	daN.m min. max.		0,5 0,9	0,5 0,9	0,6 1	0,6 1

Las prestaciones dependen de los fluidos, del material y del tubo utilizados.
El uso está garantizado para un vacío de 755 mm Hg (99% de vacío).
Prestaciones técnicas testadas a -25°C conforme con ISO 14743 estándar.

Reglamentaciones

- ISO 14743
- RoHS
- REACH
- FDA : 21 CFR
- PED

Materiales

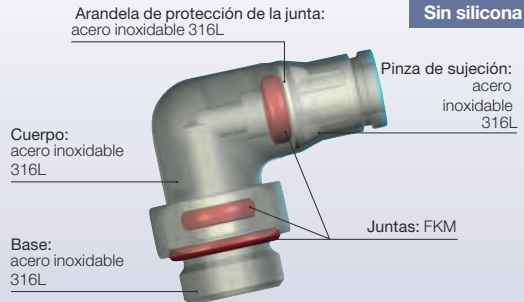

Ventajas

- Resistencia a la corrosión debido al material del componente
- Adecuado para el contacto permanente con productos alimenticios
- Adecuado para productos de limpieza y detergentes industriales
- Diseño exterior higiénico, para reducir las áreas de retención

01 // Racores

Racores instantáneos

LF 3800

3805 Racor de entrada recto, rosca macho BSPT

Acero inox 316L, FKM

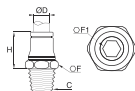

ØD	C		F	F1	H	Kg
4	R1/8	3805 04 10	10	3	14,5	0,008
	R1/4	3805 04 13	14	3	14,5	0,015
6	R1/8	3805 06 10	13	4	18	0,012
	R1/4	3805 06 13	14	4	16,5	0,018
8	R1/8	3805 08 10	15	5	19	0,014
	R1/4	3805 08 13	15	6	18	0,018
10	R3/8	3805 08 17	17	6	18,5	0,025
	R1/4	3805 10 13	19	6	24	0,029
12	R3/8	3805 10 17	19	6	22,5	0,030
	R1/4	3805 12 13	22	7	25	0,034
12	R3/8	3805 12 17	22	8	24	0,040
	R1/2	3805 12 21	22	10	23	0,046

3805 Racor de entrada recto, rosca macho NPT

Acero inox 316L, FKM

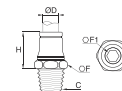

ØD	C		F	F1	H	Kg
4	NPT1/8	3805 04 11	11	3	14,5	0,009
	NPT1/4	3805 06 11	13	4	18	0,012
6	NPT1/8	3805 06 14	14	4	16,5	0,017
	NPT1/4	3805 08 11	15	5	19	0,015
8	NPT1/4	3805 08 14	15	6	18	0,018
	NPT3/8	3805 10 14	19	7	22,5	0,031
10	NPT1/4	3805 12 14	22	7	25	0,034
	NPT3/8	3805 12 18	22	8	24	0,039
12	NPT1/2	3805 12 22	22	10	23	0,045

Racores instantáneos LF 3800 / Racores de implantación

3805 Racor de entrada recto, rosca macho NPT

Pulgadas

Acero inox 316L, FKM

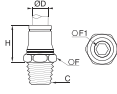

ØD	C		F	F1	H	Kg
3/16	NPT1/8	3805 55 11	10	3	15,5	0,010
	NPT1/8	3805 56 11	13	4	19	0,012
1/4	NPT1/4	3805 56 14	14	4	17,5	0,017
	NPT1/4	3805 60 14	19	6	25	0,029
3/8	NPT3/8	3805 60 18	19	7	24	0,031
	NPT1/4	3805 62 14	22	7	26	0,036
1/2	NPT3/8	3805 62 18	22	8	25	0,041
	NPT1/2	3805 62 22	22	10	25	0,049

5/32"(4 mm) y 5/16"(8 mm) también disponible

3801 Racor de entrada recto, rosca macho BSPP y métrica

Acero inox 316L, FKM

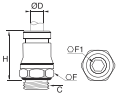

ØD	C		F	F1	H	Kg
4	M5x0,8	3801 04 19	10	2,5	17	0,005
	G1/8	3801 04 10	13	3	16,5	0,009
6	M5x0,8	3801 06 19	13	2,5	20,5	0,010
	G1/8	3801 06 10	13	4	18	0,010
8	G1/4	3801 06 13	17	4	18	0,015
	G1/8	3801 08 10	15	5	19	0,013
8	G1/4	3801 08 13	17	5	20,5	0,017
	G3/8	3801 08 17	21	6	20	0,027
10	G1/4	3801 10 13	19	7	25	0,025
	G3/8	3801 10 17	21	7	25	0,034
12	G1/4	3801 12 13	21	7	27	0,030
	G3/8	3801 12 17	21	9	26,5	0,034

3821 Adaptador enclavable, rosca macho BSPT

Acero inox 316L

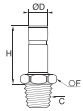

ØD	C		F	H	Kg
4	R1/8	3821 04 10	10	21	0,006
	R1/8	3821 06 10	10	23	0,007
6	R1/4	3821 06 13	14	24	0,015
	R1/8	3821 08 10	11	24	0,008
8	R1/4	3821 08 13	14	25	0,016
	R1/4	3821 10 13	19	30	0,017
10	R3/8	3821 10 17	19	30	0,022
	R1/4	3821 12 13	19	31	0,017
12	R3/8	3821 12 17	19	31	0,022
	R1/2	3821 12 21	22	32	0,037

3821 Adaptador enclavable, rosca macho NPT

Acero inox 316L

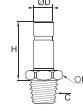

ØD	C		F	H	Kg
4	NPT1/8	3821 04 11	10	21	0,006
	NPT1/8	3821 06 11	10	23	0,007
6	NPT1/4	3821 06 14	14	24	0,016
	NPT1/8	3821 08 11	14	24	0,008
8	NPT1/4	3821 08 14	14	25	0,016
	NPT1/4	3821 10 14	14	30	0,018
10	NPT3/8	3821 10 18	17	30	0,010
	NPT1/4	3821 12 14	14	31	0,018

3821 Adaptador enclavable, rosca macho NPT

Pulgadas

Acero inox 316L

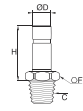

ØD	C		F	H	Kg
1/4	NPT1/8	3821 56 11	10	26	0,009
	NPT1/4	3821 56 14	14	27	0,016
3/8	NPT1/4	3821 60 14	19	32	0,018
	NPT3/8	3821 60 18	19	32	0,028
1/2	NPT1/4	3821 62 14	19	36	0,020
	NPT3/8	3821 62 18	19	37	0,025
12	NPT1/2	3821 62 22	22	37	0,042

5/32"(4 mm) y 5/16"(8 mm) también disponible

3831 Adaptador, rosca macho BSPP y métrica

Acero inox 316L, FKM

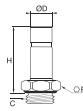

ØD	C		F	H	Kg
4	M5x0,8	3831 04 19	10	23,5	0,004
	G1/8	3831 04 10	13	22	0,008
6	G1/8	3831 06 10	13	24	0,009
	G1/4	3831 06 13	17	24	0,015
8	G1/8	3831 08 10	13	25	0,010
	G1/4	3831 08 13	17	27	0,019
8	G3/8	3831 08 17	21	27	0,024
	G1/4	3831 10 13	17	32	0,021
10	G3/8	3831 10 17	21	32	0,025
	G1/4	3831 12 13	17	33	0,021
12	G3/8	3831 12 17	21	33	0,028
	G1/2	3831 12 21	24	36	0,043

Los adaptadores enclavables 3821 y 3831 permiten, gracias a su facilidad de uso:

- reducir la gama de racores en stock
- instalar racores en te o de codo según las necesidades

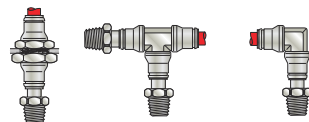

Racores instantáneos LF 3800 / Racores de implantación

3800 Cartucho monobloque

Acero inox 316L, FKM

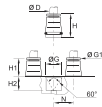

ØD		G	G1	H	H1	H2	N	Kg
4	3800 04 00	9,8	8	17	8,5	8,5	11	0,006
6	3800 06 00	12,1	10	19	10,5	8,5	13,5	0,008
8	3800 08 00	14,8	13	21	12,5	8,5	16	0,012
10	3800 10 00	17,5	15	24,5	14	10,5	20	0,019

Dimensiones de la cavidad disponibles a petición

3809 Codo, rosca macho BSPT

Acero inox 316L, FKM

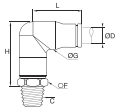

ØD	C		F	G	H	L	Kg
4	R1/8	3809 04 10	10	10	23,5	16,5	0,020
	R1/8	3809 06 10	13	12	27,5	20	0,030
6	R1/4	3809 06 13	14	12	27,5	25	0,036
	R1/8	3809 08 10	14	15	32	25	0,040
8	R1/4	3809 08 13	14	14,5	34	25	0,045
	R1/4	3809 10 13	19	17,5	37,5	27,5	0,068
10	R3/8	3809 10 17	19	17,5	37,5	27,5	0,069

Racor orientable

3809 Codo, rosca macho BSPT

Acero inox 316L, FKM

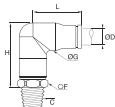

ØD	C		F	G	H	L	Kg
6	NPT1/8	3809 06 11	13	12,5	29	22,5	0,031
	NPT1/4	3809 06 14	14	12,5	29	22,5	0,036
8	NPT1/8	3809 08 11	14	15	34	24	0,040
	NPT1/4	3809 08 14	14	15	34	24	0,045
10	NPT1/4	3809 10 14	19	17,5	39,5	30	0,068
	NPT3/8	3809 10 18	19	17,5	39,5	30	0,071

Racor orientable

3899 Codo compacto, rosca macho BSPP y métrica

Acero inox 316L, FKM

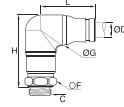

ØD	C		F	G	H	L	Kg
4	M5x0,8	3899 04 19	10	10	26	18	0,020
	G1/8	3899 04 10	13	10	27	19	0,022
6	G1/4	3899 04 13	17	10	27	19	0,018
	M5x0,8	3899 06 19	13	12	33	24	0,031
6	G1/8	3899 06 10	6	12	33	24	0,031
	G1/4	3899 06 13	17	12	32	24	0,036
8	G1/8	3899 08 10	14	15	35	25	0,039
	G1/4	3899 08 13	17	15	35	25	0,044
8	G3/8	3899 08 17	21	15	34,5	25	0,048
	G1/4	3899 10 13	19	17	43	31	0,069
10	G3/8	3899 10 17	21	17	42	31	0,072

Racor orientable

3889 Codo compacto, rosca macho BSPT

Acero inox 316L, FKM

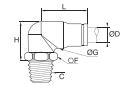

ØD	C		F	G	H	L	Kg
4	R1/8	3889 04 10	13	10	18	17	0,019
	R1/4	3889 04 13	17	10	19,5	16,5	0,018
6	R1/8	3889 06 10	13	12	21,5	20,5	0,025
	R1/4	3889 06 13	14	12	21,5	20,5	0,032
8	R1/8	3889 08 10	14	15	24	22	0,036
	R1/4	3889 08 13	14	15	24	22	0,036
10	R1/4	3889 10 13	17	17,5	28,5	27,5	0,058
	R3/8	3889 10 17	19	17,5	28,5	27,5	0,068
12	R1/4	3889 12 13	22	20	33,5	30	0,088
	R3/8	3889 12 17	22	20	33,5	30	0,090
	R1/2	3889 12 21	22	20	33,5	33	0,097

Racor orientable. Max. 20 bar

3889 Codo compacto, rosca macho NPT

Acero inox 316L, FKM

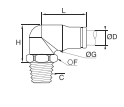

ØD	C		F	G	H	L	Kg
4	NPT1/8	3889 04 11	13	10	17,5	19	0,019
6	NPT1/8	3889 06 11	13	12,5	20	22,5	0,026
	NPT1/4	3889 06 14	14	12,5	20	22,5	0,033
8	NPT1/8	3889 08 11	13	15	25	24	0,036
	NPT1/4	3889 08 14	14	15	24	24	0,036
10	NPT1/4	3889 10 14	17	17,5	27,5	27,5	0,059
	NPT3/8	3889 10 18	19	17,5	28,5	26,5	0,068
12	NPT1/4	3889 12 14	22	20	31,5	32,5	0,086
	NPT3/8	3889 12 18	22	20	32,5	32,5	0,089
	NPT1/2	3889 12 22	22	20	27,5	32,5	0,098

Racor orientable. Max. 20 bar

Racores instantáneos LF 3800 / Racores de implantación

3889 Codo compacto, rosca macho NPT Pulgadas

Acero inox 316L, FKM

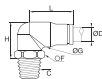

ØD	C		F	G	H	L	Kg
1/4	NPT1/8	3889 56 11	13	12	22	23	0,025
	NPT1/4	3889 56 14	14	12	22	23	0,032
3/8	NPT1/4	3889 60 14	17	17,5	28	30,5	0,058
	NPT3/8	3889 60 18	19	17,5	28	30,5	0,066
1/2	NPT1/4	3889 62 14	22	20	34	33	0,089
	NPT3/8	3889 62 18	22	20	34	33	0,089
	NPT1/2	3889 62 22	22	20	27	33	0,091

Racor orientable. Max. 20 bar.
5/32"(4 mm) y 5/16"(8 mm) también disponible.

3879 Codo compacto, rosca macho BSPP

Acero inox 316L, FKM

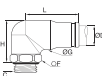

ØD	C		F	G	H	L	Kg
4	G1/8	3879 04 10	13	11	22	19	0,022
	G1/4	3879 04 13	17	11	20	19	0,027
6	G1/8	3879 06 10	13	12	24	24	0,029
	G1/4	3879 06 13	17	12	22	24	0,034
8	G1/8	3879 08 10	13	15	25	25	0,035
	G1/4	3879 08 13	17	15	25	25	0,039
	G3/8	3879 08 17	21	15	23	25	0,047
10	G1/4	3879 10 13	18	17	28,5	31	0,057
	G3/8	3879 10 17	21	17	28,5	31	0,065
	G1/4	3879 12 13	17	20	33	33	0,077
12	G3/8	3879 12 17	21	20	33	33	0,084
	G1/2	3879 12 21	24	20	30	33	0,096

Racor orientable. Max. 20 bar

3893 Te, rosca macho lateral BSPP y métrica

Acero inox 316L, FKM

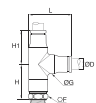

ØD	C		F	G	H	H1	L	Kg
8	G3/8	3893 08 17	21	15	27	25	35,5	0,094

Racor orientable.

El diseño del sistema LF 3800 permite su conexión con diversos tubos Parker Legris presentes en este catálogo, capítulo 3 "Tubos técnicos":

- Tubo PFA
- Tubo fluoropolímero FEP
- Tubo polietileno
- Tubos de poliamida semi-rígida y poliuretano cristal flexible

Racores instantáneos LF 3800 / Racores de unión



01 // Racores

Racores instantáneos

LF 3800

3806 Unión igual

Acero inox 316L, FKM

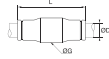

ØD		G	L	Kg
4	3806 04 00	10	29	0,009
6	3806 06 00	12	34	0,015
8	3806 08 00	15	36	0,019
10	3806 10 00	17,5	45	0,032
12	3806 12 00	20	46,5	0,040

3804 Te igual

Acero inox 316L, FKM

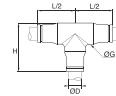

ØD		G	H	L/2	Kg
4	3804 04 00	10	22	19	0,020
6	3804 06 00	12	26	24	0,031
8	3804 08 00	15	29,5	25	0,040
10	3804 10 00	17,5	36,5	31	0,063
12	3804 12 00	20	40	33	0,087

3806 Unión igual

Pulgadas

Acero inox 316L, FKM

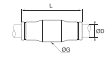

ØD		G	L	Kg
3/16	3806 55 00	11	31	0,010
1/4	3806 56 00	12	36	0,015
3/8	3806 60 00	17	47	0,030
1/2	3806 62 00	20	48	0,039

5/32";(4 mm) y 5/16";(8 mm) también disponible

3804 Te igual

Pulgadas

Acero inox 316L, FKM

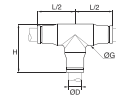

ØD		G	H	L/2	Kg
1/4	3804 56 00	12	30	23	0,031
3/8	3804 60 00	17	38	29	0,059
1/2	3804 62 00	20	43	33	0,088

5/32";(4 mm) y 5/16";(8 mm) también disponible

3802 Unión igual

Acero inox 316L, FKM

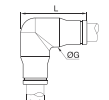

ØD		G	L	Kg
4	3802 04 00	10	21,5	0,015
6	3802 06 00	12	26,5	0,024
8	3802 08 00	15	29,5	0,031
10	3802 10 00	17,5	36,5	0,050
12	3802 12 00	20	40	0,071

3802 Unión igual

Pulgadas

Acero inox 316L, FKM

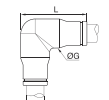

ØD		G	L	Kg
1/4	3802 56 00	12	29	0,023
3/8	3802 60 00	17	38	0,047
1/2	3802 62 00	20	43	0,071

5/32";(4 mm) y 5/16";(8 mm) también disponible

Racores instantáneos LF 3800

3816 Unión doble igual pasatabiques

Acero inox 316L, FKM

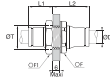

ØD		F	F1	L1	L2	ØT	Kg
4	3816 04 00	13	14	13,5	19,5	13	0,017
6	3816 06 00	17	17	16,5	21,5	14	0,027
8	3816 08 00	19	19	18	24	16	0,034
10	3816 10 00	22	22	21,5	27,5	21	0,048
12	3816 12 00	24	24	24	29	23	0,059

Clase de estanqueidad IP55

3826 Reductor enclavable

Acero inox 316L

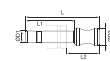

ØD1	ØD2		L	L1	L2	Kg
4	6	3826 04 00	25	17	11	0,003
6	8	3826 06 00	30,4	19,5	13,5	0,007
8	10	3826 08 00	33	20	14	0,014
10	12	3826 10 00	40	25	17	0,025
12	14	3826 12 00	43	26	19	0,039

3816 Unión doble igual pasatabiques

Pulgadas

Acero inox 316L, FKM

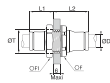

ØD		F	F1	L1	L2	ØT	Kg
3/16	3816 55 00	17	13	15	18	12,5	0,017
1/4	3816 56 00	19	17	19	21	15	0,027
3/8	3816 60 00	22	22	22	27	21	0,052
1/2	3816 62 00	27	27	25	28	25	0,076

Clase de estanqueidad IP55
5/32";(4 mm) et 5/16";(8 mm) también disponible

3800 Aparato para ranurar tubos de acero inoxidable, milimétricos y en pulgadas

Acero tratado

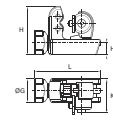

	G	H	H1	K	L	Kg
3800 70 00	25	51	13	36	70	0,326

Este aparato está pensado para ranurar correctamente tubos de acero inoxidable, de diámetro exterior 4 mm a 12 mm inclusive, y de 3/16 a 1/2 pulgada inclusive, permitiendo así un perfecto cierre instantáneo, entre el tubo y el racor LF-3800.

3866 Reductor enclavable

Acero inox 316L, FKM

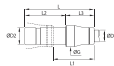

ØD1	ØD2		G	L	L1	L2	L3	Kg
4	6	3866 04 06	10	35	19	19	16	0,008
4	8	3866 04 08	10	34	17	20	14	0,011
6	8	3866 06 08	12	42	24	23	19	0,015
6	10	3866 06 10	12	41	19	25	16	0,019
8	10	3866 08 10	15	45	22,5	25	20	0,021
8	12	3866 08 12	15	43	20	26	17	0,025
10	12	3866 10 12	17	50	23	26	24	0,029

Racores instantáneos LF 6800



Conexiones con limpieza reforzada, para aplicaciones médicas, de acuerdo con las normas del campo de aplicación.

Ø métrico:
4 a 12 mm

Características técnicas

- **Fluidos adecuados:** Respiración, gases médicos neutros y puros. Otros fluidos: por favor, consúltenos
- **Presión de trabajo :** De vacío hasta 15 bar. La presión de trabajo varía según la temperatura (véase más abajo).
- **Temperatura de trabajo :** -10°C a +95°C

Par de apriete (métrico & BSPP)	Rosca	M5 x0,8	G1/8	G1/4	G3/8	G1/2
	daN.m	1,16	0,8	1,2	3	3,5

Las prestaciones dependen de los fluidos, del material y del tubo utilizados. El uso está garantizado para un vacío de 755 mm Hg (99% de vacío).

Ventajas

- Compatibilidad con las normas ASTM
- Recomendado para aplicaciones de O₂ y gas limpio
- Sin bisfenol ni ftalatos

Materiales

Sin silicona

Cuerpo:
polímero de origen ecológico

Botón de liberación negro:
polímero técnico

Arandela:
acero inoxidable

Base:
polímero o latón niquelado
químico

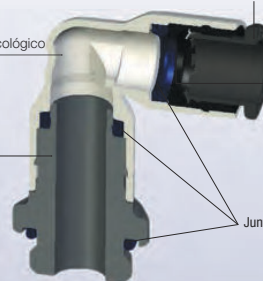

Junta: EPDM

**ECO
DESIGN**

Reglamentaciones

- RoHS
- REACH

BAM: Residuo de
certificación de grasa

6801 Racor de entrada recto, rosca macho BSPP y métrica

Latón niquelado químico, EPDM

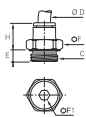

ØD	C		E	F	F1	H	Kg
4	M5x0,8	6801 04 19	3	8	2,5	14	0,003
	G1/8	6801 04 10	5,5	13	3	11,5	0,007
	G1/4	6801 04 13	5,5	16	3	10,5	0,011
6	M5x0,8	6801 06 19	3	10	2,5	16	0,005
	G1/8	6801 06 10	4,5	13	4	13	0,007
	G1/4	6801 06 13	5,5	16	4	12,5	0,011
8	G1/8	6801 08 10	4,5	13	5	20,5	0,011
	G1/4	6801 08 13	5,5	16	6	19,5	0,016
	G3/8	6801 08 17	5,5	20	6	18	0,022
10	G1/4	6801 10 13	5,5	16	7	23	0,018
	G3/8	6801 10 17	5,5	20	8	19,5	0,021
	G1/2	6801 10 21	7	24	8	18	0,033
12	G3/8	6801 12 17	5,5	20	9	27	0,029
	G1/2	6801 12 21	7	24	10	22,5	0,035

6814 Racor de entrada recto, rosca hembra BSPP

Latón niquelado químico, EPDM



ØD	C		E	F	H	Kg
4	G1/8	6814 04 10	9,5	13	22,5	0,010
	G1/8	6814 06 10	9,5	13	24,5	0,011
	G1/4	6814 06 13	13,5	16	28,5	0,017
6	G1/8	6814 08 10	9,5	13	29	0,015
	G1/4	6814 08 13	13,5	16	33	0,021
	G3/8	6814 08 17	14	19	34	0,025
8	G1/4	6814 10 13	13,5	16	36	0,027
	G3/8	6814 10 17	14	19	36	0,027
	G1/2	6814 10 21	19,5	24	41,5	0,048
10	G3/8	6814 12 17	14	19	40	0,033
	G1/2	6814 12 21	19,5	24	45,5	0,052

Aplicaciones para entornos médicos y salas limpias

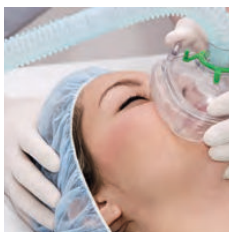

Racores instantáneos LF 6800

6899 Codo rígido, rosca macho BSPP y métrica

Bio-polímero, Latón niquelado químico FDA, EPDM

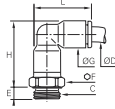

ØD	C		E	F	G	H	L	Kg
4	M5x0,8	6899 04 19	3,5	8	8,5	23	19	0,002
	G1/8	6899 04 10	4,5	13	8,5	22,5	19	0,006
	G1/4	6899 04 13	5,5	16	8,5	22,5	19	0,011
6	M5x0,8	6899 06 19	3,5	10	10,5	26,5	22,5	0,003
	G1/8	6899 06 10	4,5	13	10,5	26,5	22,5	0,006
	G1/4	6899 06 13	5,5	16	10,5	26,5	22,5	0,011
8	G1/8	6899 08 10	4,5	13	13,5	35	29,5	0,009
	G1/4	6899 08 13	5,5	16	13,5	33	29,5	0,012

Racor orientable.

6806 Unión igual

Bio-polímero, EPDM

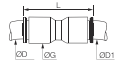

ØD	ØD1		G	L	Kg
4	4	6806 04 00	8,5	26,5	0,002
6	6	6806 06 00	10,5	30	0,004
8	8	6806 08 00	13,5	37	0,004
10	10	6806 10 00	16	42	0,009
12	12	6806 12 00	19	50,5	0,009

6802 Unión igual

Bio-polímero, EPDM

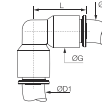

ØD	ØD1		G	L	Kg
4	4	6802 04 00	8,5	19	0,002
6	6	6802 06 00	10,5	24	0,004
8	8	6802 08 00	13,5	29	0,004
10	10	6802 10 00	16	34,5	0,005
12	12	6802 12 00	19	40,5	0,010

6804 Te igual

Bio-polímero, EPDM

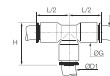

ØD	ØD1		G	H	L/2	Kg
4	4	6804 04 00	8,5	20	15,5	0,004
6	6	6804 06 00	10,5	23	18	0,006
8	8	6804 08 00	13,5	29	22,5	0,006
10	10	6804 10 00	16	34,5	26,5	0,009
12	12	6804 12 00	19	40	31	0,014

6840 Y simple igual

Bio-polímero, EPDM

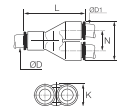

ØD	ØD1		H	K	L	N	Kg
4	4	6840 04 00	17,5	8,5	30	9	0,004
6	6	6840 06 00	21,5	10,5	36,5	11	0,008
8	8	6840 08 00	28	13,5	44,5	14,5	0,007
10	10	6840 10 00	33	16	53	17	0,010
12	12	6840 12 00	39	19	60,5	20	0,025

Productos complementarios para los racores instantáneos LF 6800

Tubos PU & PFA



Cartuchos para aplicaciones de O₂



Sólo bajo pedido.

Cierre esférico, serie universal semi-especial, aplicaciones de O₂



Con el sufijo 30

Racores con funciones para aplicaciones de O₂



Sólo bajo pedido.

Racores instantáneos LF 6800



6816 Unión doble pasatabiques igual

Bio-polímero, EPDM

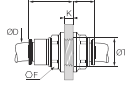

ØD		F	K max	L	L1	ØT min	Kg
4	6816 04 00	13	5,5	15,5	10,5	10,5	0,018
6	6816 06 00	15	8,5	20	10	12,5	0,004
8	6816 08 00	18	14,5	27	10,5	15,5	0,007
10	6816 10 00	22	14,5	30	13	18,5	0,012
12	6816 12 00	26	18,5	35	15,5	22,5	0,020

6866 Reductor enclavable

Bio-polímero, EPDM

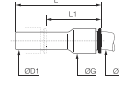

ØD	ØD1		G	L	L1	Kg
4	6	6866 04 06	8,5	38	23,5	0,004
6	8	6866 06 08	10,5	38	20	0,004
	10	6866 06 10	10,5	39	17,5	0,002
8	10	6866 08 10	13,5	48,5	28,5	0,009
	12	6866 08 12	13,5	48,5	24,5	0,004

6882 Codo igual y desigual enclavable

Bio-polímero, EPDM

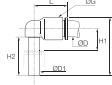

ØD	ØD1		G	H	H1	H2	L	Kg
4	4	6882 04 00	8,5	23	6	15,5	15	0,005
	6	6882 04 06	10,5	26,5	7	17	16,5	0,002
6	6	6882 06 00	10,5	26,5	7	17	17	0,003
	8	6882 06 08	13,5	33,5	8	21,5	22,5	0,004
8	8	6882 08 00	13,5	33,5	8	21,5	22,5	0,004

La referencia de 4 mm de diámetro no está ranurada en la versión estándar.

6826 Tapón enclavable

Bio-polímero

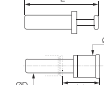

ØD			G	L	L1	Kg
4	6826 04 00		6	30	15,5	0,001
6	6826 06 00		8	33	16,5	0,001
8	6826 08 00		10	35	17,5	0,002
10	6826 10 00		12	42	21	0,003
12	6826 12 00		14	45	22	0,004

6888 Te igual enclavable central

Bio-polímero, EPDM

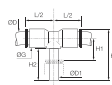

ØD	ØD1		G	H	H1	H2	L/2	Kg
4	4	6888 04 00	8,5	25	6	15,5	15	0,005
6	6	6888 06 00	10,5	28,5	7	17	16	0,006
8	8	6888 08 00	13,5	33,5	8	21,5	23	0,005

6883 Te igual enclavable lateral

Bio-polímero, EPDM

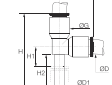

ØD	ØD1		G	H	H1	H2	L	Kg
4	4	6883 04 00	8,5	33	6	15,5	15	0,002
6	6	6883 06 00	10,5	38,5	7	17	18	0,002
8	8	6883 08 00	13,5	49	8	21,5	23	0,005

Racores instantáneos LF 6100



Dedicada a aplicaciones de lubricación y vacío, esta tecnología asegura el agarre y el nivel de estanqueidad a altas presiones.

Ø métrico:
4 a 10 mm

Características técnicas

- **Fluidos adecuados:** Lubricantes, aire comprimido, vacío, otros fluidos y gases compatibles
- **Presión de trabajo:** De vacío hasta 60 bar
- **Temperatura de trabajo:** -40°C a +120°C

Par de apriete
mín./máx.
(daN.m)

Rosca	M6 x1	M8 x1	M8 x1,25	M10 x1	M12 x1	M14 x1,5	R 1/8	R 1/4
Cónica	0,2/ 0,6	0,2/ 1,2	0,2/ 1	0,2/ 1,2	0,2/ 2	0,5/ 1,5	0,2/ 1,0	0,5/ 1,5
Cilíndrica	-	0,6/ 1	-	0,6/ 1	1,8/ 2,2	-	-	-

Las prestaciones dependen de los fluidos, del material y del tubo utilizados. El uso está garantizado para un vacío de 755 mm Hg (99% de vacío).

Ventajas

- La estanqueidad está asegurada por 3 juntas
- Seguridad de separación, no es posible sin herramientas
- Puede utilizarse hasta 60 bar, con tubos de metal o polímero rígidos o ranurados

Materiales

Sin silicona



Reglamentaciones

- PED
- RoHS
- REACH

6105 Racor de entrada recto, rosca macho BSPT y métrica cónica

Latón, NBR



ØD	C		F1	F2	H	Kg
4	M6x1	6105 04 52	13	11	16,5	0,013
	M8x1	6105 04 56	13	11	14,5	0,012
	M8x1,25	6105 04 57	13	11	14,5	0,012
	M10x1	6105 04 60	13	11	14,5	0,015
	R1/8	6105 04 10	13	11	14,5	0,014
6	R1/4	6105 04 13	14	11	12,5	0,018
	M10x1	6105 06 60	17	14	16,5	0,024
	R1/8	6105 06 10	17	14	17,5	0,026
8	R1/4	6105 06 13	17	14	16,5	0,029
	M12x1	6105 08 65	19	21	24	0,041
10	M14x1,5	6105 10 71	22	24	26	0,005

6101 Racor de entrada recto, rosca macho métrica cilíndrica

Latón, NBR



ØD	C		F1	F2	H	Kg
4	M10x1	6101 04 60	13	11	14	0,014
	M10x1	6101 06 60	17	14	17,5	0,026
6	M12x1	6101 06 65	17	14	16,5	0,025

6114 Racor de entrada recto, rosca macho métrica cilíndrica

Latón, NBR

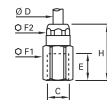

ØD	C		E	F1	F2	H	Kg
4	M8x1	6114 04 56	8	13	11	25,5	0,021
6	M8x1	6114 06 56	8	17	14	28,5	0,043

6179 Codo rígido, rosca macho BSPT y métrica cónica

Latón, NBR

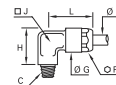

ØD	C		F	G	H	J	L	Kg
4	M6x1	6179 04 52	11	12,5	14,5	8	20	0,017
	M8x1	6179 04 56	11	12,5	14,5	8	20	0,018
	M8x1,25	6179 04 57	11	12,5	15	8	20	0,017
	M10x1	6179 04 60	11	12,5	15,5	8	20	0,019
	R1/8	6179 04 10	11	12,5	15	8	20	0,019
6	R1/4	6179 04 13	11	12,5	17	10	20	0,030
	M10x1	6179 06 60	14	16	18	10	25,5	0,033
	M12x1	6179 06 65	14	16	18	10	25,5	0,032
8	R1/8	6179 06 10	14	16	18	10	25,5	0,035
	R1/4	6179 06 13	14	16	19	10	25,5	0,036
10	M12x1	6179 08 65	17	19	17,5	12	30	0,054

Racores instantáneos LF 6100

6106 Unión igual

Latón, NBR

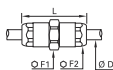

ØD		F1	F2	L	Kg
4	6106 04 00	13	11	34	0,025
6	6106 06 00	17	14	39	0,044
8	6106 08 00	19	17	46	0,069

6104 Te igual

Latón, NBR

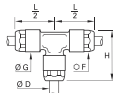

ØD		F	G	H	L/2	Kg
4	6104 04 00	11	12,5	26,5	20	0,034
6	6104 06 00	14	16	36	25,5	0,081
8	6104 08 00	17	19	39	30	0,111

0138 Junta de cobre

Cobre



C		G1	G2	K	Kg
M6	0138 06 00	6,2	9,9	1	0,033
M8	0138 08 00	8,2	11,4	1	0,001
G1/8	0138 10 00	10,2	13,4	1	0,001
M12	0138 12 00	12,2	15,4	1,5	0,001
M14	0138 14 00	14,2	17,9	1,5	0,001
M16	0138 16 00	16,2	19,9	1,5	0,001
M18	0138 18 00	18,2	21,9	1,5	0,001
M20	0138 20 00	20,2	23,9	1,5	0,001
M22	0138 22 00	22,2	26,9	1,5	0,002
M24	0138 24 00	24,3	28,9	2	0,003
M26	0138 26 00	26,3	30,9	2	0,003
M30	0138 30 00	30,3	37,9	2	0,004
M36	0138 36 00	36,3	41,9	2	0,005
G1/4	0138 13 00	13,2	17,9	1,5	0,001
G3/8	0138 17 00	17,2	20,9	1,5	0,001
G1/2	0138 21 00	21,1	25,9	1,5	0,002
G3/4	0138 27 00	27,3	31,9	2	0,003
G1	0138 33 00	33,3	38,9	2	0,005
G1 1/4	0138 42 00	42,3	48,9	2	0,007
G2	0138 60 00	60,5	67,8	2,5	0,014

DIN 7603
ISO 65061

Accesorios para racores instantáneos



Mejorar la seguridad y la identificación de los circuitos.

Ø métrica: 4 a 16 mm
Ø pulgadas: 1/4" a 1/2"

Características técnicas

- **Racores adecuados:** LF 3000®, LIQUIfit®
- **Temperatura de trabajo:** -20°C a +95°C
- **Materiales:** Clip de seguridad, botón-pulsador, regleta de clips: polímero técnico

Ventajas

Seguridad:

- Eliminación del riesgo de desconexión involuntaria

Identificación:

- 6 colores para codificar los circuitos
- Fácil desmontaje con la herramienta de desconexión

3130 Clip de seguridad

Polímero técnico



ØD	●	●	●	●	●	○	H	K	Kg
4		3130 04 02	3130 04 03	3130 04 04	3130 04 05		6,6	3	0,001
6	3130 06 01	3130 06 02	3130 06 03	3130 06 04	3130 06 05	3130 06 10	7,8	3,1	0,001
8	3130 08 01	3130 08 02	3130 08 03	3130 08 04	3130 08 05	3130 08 10	9,5	4,3	0,001
10	3130 10 01	3130 10 02	3130 10 03	3130 10 04	3130 10 05	3130 10 10	10,8	4,2	0,002
12	3130 12 01		3130 12 03	3130 12 04	3130 12 05	3130 12 10	12,5	5,1	0,003
14	3130 14 01		3130 14 03				15	6	0,004
16			3130 16 03				27	1,7	0,004
1/4	3130 56 01		3130 56 03	3130 56 04		3130 56 10	8	3	0,001
3/8	3130 60 01						11	4	0,001
1/2			3130 62 03	3130 62 04			14	6	0,004

Instalación

Clip de seguridad



Botón-pulsador

Los botones-pulsadores de distintos colores se montan en los pulsadores de los racores LF 3000® y LIQUIfit®. Amovibles, están disponibles en 5 colores y permiten un código de identificación en los circuitos.



Herramienta de desmontaje

En caso de acceso difícil, se recomienda utilizar esta herramienta de montaje.

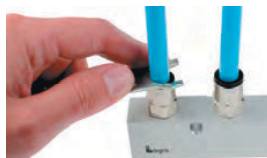

Regleta de clips

Los clips permiten fijar en espacios restringidos los tubos y racores LF 3000®.





Accesorios para racores instantáneos

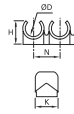

CLIP Regleta de clips para tubos y racores

Polímero técnico



ØD		Numero de salidas	H	K	N	Kg
4	 CLIP 04 00	8	9	13,5	10,5	0,007
6	CLIP 06 00	8	10,5	13	10,5	0,008
8	CLIP 08 00	7	12,5	10,5	12	0,007
10	CLIP 10 00	6	14	12	15	0,005
12	CLIP 12 00	5	16,5	14	16,5	0,009
14	CLIP 14 00	4	18	16	20,5	0,009

Suministrado en cajas de 10 regletas de clips del mismo diámetro (con tornillo autorroscante de 9,5 mm de longitud).

Estos clips se puede utilizar tanto con tubos métricos como el equivalente pulgadas de tubo.

3000 70 Útil para desconexión

Acero tratado







	H	H1	L	Kg
3000 70 00	25	20	96	0,021

Para la desconexión del tubo en los racores LF 3000®, es aconsejable utilizar este útil de desconexión, en especial cuando el racor tiene un difícil acceso.
Esta útil se puede utilizar con tubos de diámetro exterior 4, 5, 6, 8, 10, 12 y 14 mm.

3110 Funda para pulsador amovible

Polímero técnico



ØD						Kg
4	3110 04 00	3110 04 02	3110 04 03	3110 04 04	3110 04 05	0,001
6	3110 06 00	3110 06 02	3110 06 03	3110 06 04	3110 06 05	0,001
8	3110 08 00	3110 08 02	3110 08 03	3110 08 04	3110 08 05	0,001
10	3110 10 00	3110 10 02	3110 10 03	3110 10 04	3110 10 05	0,001
12	3110 12 00	3110 12 02	3110 12 03	3110 12 04	3110 12 05	0,001
14	3110 14 00	3110 14 02	3110 14 03	3110 14 04		0,002
1/4		3110 56 02	3110 56 03	3110 56 04		0,001
3/8	3110 60 00			3110 60 04	3110 60 05	0,001

0605 Rollo Cinta fluoropolímero

FKM



Kg

0605 12 12	0,012
-------------------	-------

Temperatura de utilización : de -250°C a +260°C

Químicamente inerte y resistente al gas, ácidos, disolventes, hidrocarburos, aceites, vapores alcalinos, etc

Hidrófugo. No tóxico. Auto-lubricante

Reemplaza la pasta de juntas, la cera y la estopada de forma totalmente limpia

Presentación bobinado y estuchado CFR21 .

Presentación bobinado y estuchado : longitud = 12 m ; ancho = 12,7 mm ; espesor = 0,08 mm.

Racores reguladores de caudal

Racores de bloqueo

Racores con función pilotada

Válvulas de purga rápida metálicas

Racores anti-retorno

Racores anti-retorno LIQUIfit®

Racores de arranque progresivo

Racores reguladores

Racores captadores de detección neumática

Racores de intervención

Válvulas de mando manual

Silenciadores







**RACORES CON
FUNCIONES**

Racores con funciones

	Materiales	Fluidos	Presión máxima (bar)	Temperaturas		Resistencia en entornos agresivos		Página
				mín.	máx.	Mecánica	Química	
Racores con funciones								
Reguladores de polímero 	Polímero técnico / latón niquelado/NBR	Aire comprimido	10	0°C	+70°C	Buena	Moderada	92
Reguladores metálicos de latón 	Latón tratado / latón niquelado/NBR	Aire comprimido	10	-25°C	+70°C	Excelente	Moderada	96
Válvulas anti-retorno de acero inoxidable 	Acero inoxidable 316L/FKM	Aire comprimido	40	-15°C	+120°C	Excelente	Excelente	99
Racores de bloqueo 	Latón niquelado/NBR	Aire comprimido	10	-20°C	+70°C	Excelente	Buena	111
Válvula anti-retorno pilotada 	Polímero técnico / latón niquelado/NBR	Aire comprimido	10	-5°C	+60°C	Buena	Moderada	113
Válvulas de purga rápida metálicas 	Latón niquelado, aluminio, acero inoxidable/PU-FKM	Aire comprimido	10	-20°C	+70°C	Excelente	Excelente	115
Válvulas anti-retorno de polímero 	Polímero técnico / latón niquelado/NBR	Aire comprimido	10	0°C	+70°C	Buena	Moderada	117
Válvulas anti-retorno regulables 	Latón niquelado	Aire comprimido	12	-20°C	+80°C	Excelente	Excelente	119
Racor anti-retorno LIQUIfit® 	POM/EPDM	Aire comprimido, agua potable, agua tratada, bebidas	10	0°C	+65°C	Buena	Moderada	121
Válvulas anti-retorno de acero inoxidable 	Acero inoxidable/FKM	Varios fluidos	40	-20°C	+180°C	Excelente	Excelente	122
Racores de arranque progresivo 	Polímero técnico / latón niquelado/NBR	Aire comprimido	10	-15°C	+60°C	Buena	Buena	123
Racores reguladores de presión 	Polímero técnico / latón niquelado/NBR	Aire comprimido	10	-5°C	+60°C	Buena	Buena	125











Racores con funciones

	Materiales	Fluidos	Presión máxima (bar)	Temperaturas		Resistencia en entornos agresivos		Página
				mín.	máx.	Mecánica	Química	
Racores captadores de detección neumática 	Polímero, Latón tratado, NBR	Aire comprimido	8	-15°C	+60°C	Buena	Buena	127
Racores de intervención 	Polímero técnico / latón niquelado, NBR	Aire comprimido	10	-20°C	+80°C	Excelente	Buena	129
Válvulas de mando manual Racores de palanca basculante 	Polímero técnico / latón niquelado, NBR	Aire comprimido	10	-10°C	+80°C	Excelente	Buena	131
Válvulas de mando manual Racores de corredera 	Latón niquelado, aluminio, NBR	Aire comprimido	16	-5°C	+70°C	Excelente	Buena	131
Silenciadores 	Polímero, bronce sinterizado, latón niquelado, acero inoxidable	Aire comprimido	12	-20°C	+180°C	Buena	Moderada	133

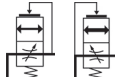
Elija su racor regulador de caudal

Proteger su instalación	Racores de bloqueo	En la parada de emergencia de una instalación neumática, aseguran el mantenimiento puntual de la carga.	Modelos 7880 - 7881 - 7883 - 7885 7886
	Racores de arranque progresivo	En caso de volver a poner en marcha una instalación neumática, garantizan un aumento progresivo de la presión, protegiendo así su instalación de cualquier choque destructivo.	Modelos 7860 - 7861 - 7870 - 7871
	Válvulas anti-retorno	Permiten el paso del aire comprimido o de un fluido en un sentido, bloqueándolo en el contrario. En caso de un corte accidental, el aire solo puede escaparse en un sentido.	Modelos 4890 - 4891 - 4892 - 4895 7930 - 7931 - 7932 - 7984 7985 - 7992 - 7994 - 7995 7996
	Válvulas anti-retorno pilotadas	Para proteger sus instalaciones, integran 3 funciones en un solo producto: válvula anti-retorno pilotada, regulador de caudal y purga manual.	Modelos 7892 - 7894
Detectar el final de carrera de un cilindro	Racores captadores con detección neumática	Emiten una señal durante la caída de presión en la cámara del cilindro. Adecuados cuando la carrera del cilindro es variable.	Modelos 7818 - 7828
Ajustar y mejorar las prestaciones de su instalación	Racores reguladores de presión	Regulan y estabilizan la presión a un valor determinado máximo, independientemente de las variaciones de presión a la entrada.	Modelos 7300
	Válvulas de purga rápida	Permiten aumentar la velocidad de retorno del cilindro pasando el escape directamente a la atmósfera.	Modelos 7899 - 7970 - 7971
	Silenciadores	Permiten reducir el nivel sonoro y evacuar el aire de la red.	Modelos 0670 - 0671 - 0672 - 0673 0674 - 0675 - 0676 - 0677
Intervenir sobre su instalación	Racores de intervención	Permiten aislar un circuito sin purgar la instalación.	Modelos 7921 - 7926 - 7960* - 7961
	Válvulas de mando manual	Permiten una purga repetitiva mediante el simple desplazamiento de la corredera de la válvula o girando la palanca de las válvulas de mando manual.	Modelos 0669 - 7800 - 7801 - 7802

Símbolos de los racores con funciones

Regular el caudal de aire		Regular la presión estabilizándola en un valor determinado	
Bloquear la circulación del aire		Reducir la presión de alimentación	
Bloquear y regular el caudal de aire		Arrancar con presión progresiva una instalación	
Permitir el paso del fluido en un sólo sentido y su anti-retorno en sentido contrario		Aislar un circuito sin purgar el conjunto de la instalación	
Permitir el escape y alimentar un circuito neumático		Regular, bloquear y purgar para proteger la instalación y a los individuos	
Captar cualquier caída de presión			

Elija su racor regulador de caudal

La amplia gama de racores reguladores de caudal Parker Legris ofrece una solución a cualquier necesidad específica de sus instalaciones automatizadas.

Elija el modelo que se adapte a su aplicación, en función de:

5 criterios determinantes

- Condiciones de uso**

 - Condiciones **estándar** → Modelos de **polímero técnico**
 - Condiciones **severas** → Modelos **metálicos**
- Tipo de implantación**

 - Sobre **cilindro** o **distribuidor roscado** → Modelos con **rosca** BSPP, BSPT y métrica
Modelos con **rosca** NPT bajo demanda
 - En **cilindro** o **distribuidor con conexión instantánea** → Modelos **enclavables**
- Espacio**

 - Aplicaciones estándar** que requieren muy buenas prestaciones de caudal para un espacio reducido → Modelos **compactos**
 - Cilindro de diámetro reducido** que necesita un caudal bajo y ocupa un espacio mínimo → Modelos **miniatura**
- Modo de regulación**

 - Regulación muy **precisa** con contratuerca de bloqueo que garantiza la **estabilidad** de la regulación → Modelos con **tornillo exterior**
 - Regulación muy **precisa** con **destornillador** y **protección** contra cualquier desajuste intempestivo → Modelos con **tornillo oculto**
- Configuración de la instalación**

 - Aplicaciones **estándar** → Modelos **banjo**
 - Salida de tubo** orientable a 180°, adaptada al movimiento del tubo → Modelos con **salida orientable**
 - Cilindro poco accesible** o ya provisto de racores con funciones → Modelos **en línea**

Racores reguladores de caudal



Disponibles con cuerpos de polímero técnico, latón niquelado o aluminio, con tornillos aparente o oculto, los reguladores de caudal combina tamaño compacto, precisión y constancia de la regulación.

Ø métrico:
3 a 14 mm

Características técnicas

- **Fluidos adecuados:** aire comprimido
Otros fluidos: consútenos
- **Presión de trabajo:** 1 a 10 bar
- **Temperatura de trabajo:** 0°C a +70°C
25°C a +70°C (versión metálica)

Par de apriete máx. (tornillo exterior)	Roscas	M3 x0,5	M5 x0,8	G1/8	G1/4	G3/8	G1/2
	daN.m	0,06	0,16	0,8	1,2	3	3,5
Par de apriete máx. (tornillo oculto)	Roscas	-	M5 x0,8	G1/8	G1/4	G3/8	G1/2
	daN.m	-	0,1	0,4	0,5	0,6	0,7

Se incluyen todas las curvas de características de caudal (a 6 bar) de los racores reguladores de caudal al final del capítulo.

Los rendimientos dependen de los fluidos y racores utilizados.

El uso está garantizado para un vacío de 755 mm Hg (99% de vacío).

Reglamentaciones

- RoHS
- REACH
- PED

Materiales

Sin silicona

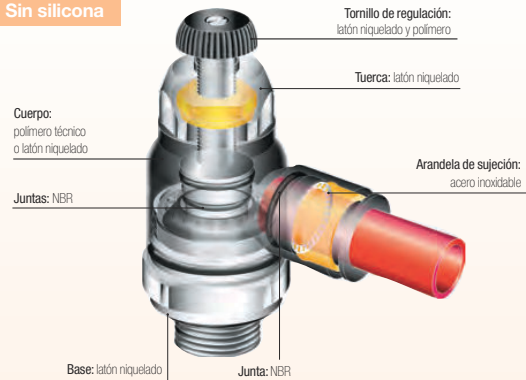

Ventajas

Productividad:

- Caudal máximo más elevado que en los reguladores estándar
- Velocidad optimizada del desplazamiento del vástago del cilindro

Precisión:

- Precisión de la regulación para un caudal progresivo
- Desplazamiento regular del vástago

Ergonomía:

- Tornillo aparente: facilidad de regulación ; Tornillo oculto: seguridad de la regulación
- Orientación a 360°

Principio de funcionamiento

Dependiendo de los modelos, los reguladores de caudal Parker Legris pueden ser unidireccionales o bidireccionales. De tipo unidireccional, regulan el caudal de aire en un sentido mediante un elemento de restricción ajustable y permiten el paso total del aire en sentido contrario.

De tipo bidireccional, permiten regular el caudal del aire en ambos sentidos.

Se obtiene una regulación de caudal más precisa y más constante con un regulador montado en el escape en el cilindro.

Modelos con tornillo oculto

Modelo unidireccional en el escape

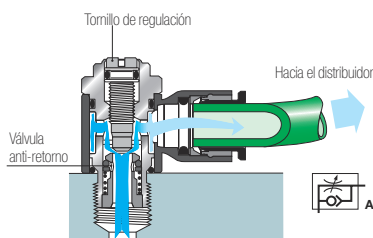

Modelo unidireccional en la alimentación

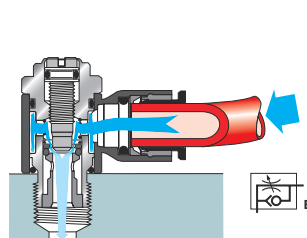

Modelo bidireccional

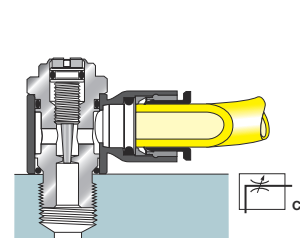

Racores reguladores de caudal

Modelos con tornillo exterior

Modelo unidireccional en el escape

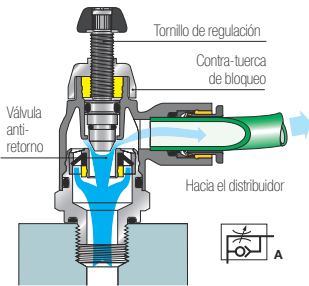

Modelo unidireccional en la alimentación

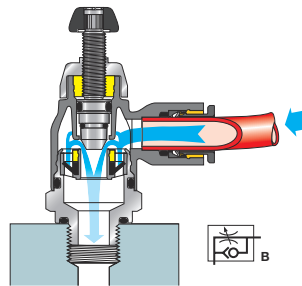

Modelo bidireccional

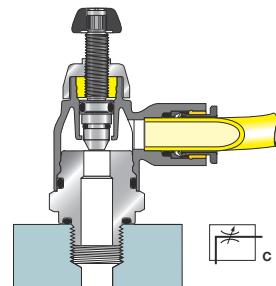

Modelos en línea

Modelo unidireccional

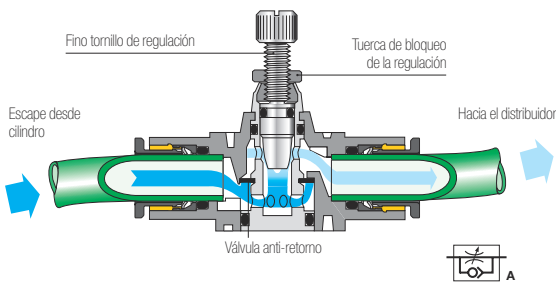

Modelo bidireccional

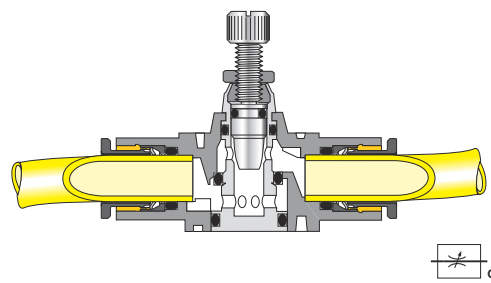

Para una identificación visual inmediata, cada versión de racores reguladores de caudal Parker Legris se identifica mediante el símbolo neumático correspondiente y con una letra:

- regulación unidireccional en el escape: letra A
- regulación unidireccional en la alimentación: letra B
- regulación bidireccional: letra C

7010 Regulador, rosca macho BSPP y métrica

Polímero técnico, Latón niquelado, NBR

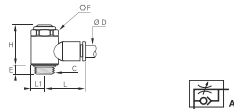

ØD	C		E	F	H	L	L1	Kg
4	M5x0,8	7010 04 19	4	8	17,5	17	5	0,006
	G1/8	7010 04 10	5	13	25	19	7	0,017
6	M5x0,8	7010 06 19	4	8	17,5	19	5	0,006
	G1/8	7010 06 10	5	13	25	21	7	0,018
8	G1/4	7010 08 13	8	17	26,5	22	9,5	0,034
	G1/8	7010 08 10	5	13	25	26	7	0,019
8	G1/4	7010 08 13	8	17	26,5	27	9,5	0,035
	G3/8	7010 08 17	7,5	20	37,5	29	11	0,068
	G1/4	7010 10 13	8	17	26,5	29	9,5	0,035
10	G3/8	7010 10 17	7,5	20	37,5	31	11	0,067
	G1/2	7010 10 21	8	23	43	37	13,5	0,117
12	G3/8	7010 12 17	7,5	20	37,5	34,5	11	0,069
	G1/2	7010 12 21	8	23	43	37	13,5	0,108

7011 Regulador, rosca macho BSPP y métrica

Polímero técnico, Latón niquelado, NBR

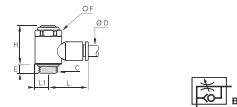

ØD	C		E	F	H	L	L1	Kg
4	M5x0,8	7011 04 19	4	8	17,5	17	5	0,006
	G1/8	7011 04 10	5	13	25	19	7	0,017
6	M5x0,8	7011 06 19	4	8	17,5	19	5	0,006
	G1/8	7011 06 10	5	13	25	21	7	0,018
8	G1/4	7011 08 13	8	17	26,5	22	9,5	0,034
	G1/8	7011 08 10	5	13	25	26	7	0,019
8	G1/4	7011 08 13	8	17	26,5	27	9,5	0,034
	G3/8	7011 08 17	7,5	20	37,5	29	11	0,067
10	G1/4	7011 10 13	8	17	26,5	29	9,5	0,036
	G3/8	7011 10 17	7,5	20	37,5	31	11	0,068

Racores reguladores de caudal de polímero / Tornillo oculto

7012 Regulador bi-direccional, rosca macho BSPP y métrica

Polímero técnico, Latón niquelado, NBR

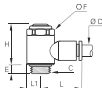

ØD	C		E	F	H	L	L1	ØT	Kg
4	M5x0,8	7012 04 19	4	8	17,5	17	5	0,006	
	G1/8	7012 04 10	5	13	25	19	7	0,018	
6	M5x0,8	7012 06 19	4	8	17,5	19	5	0,006	
	G1/8	7012 06 10	5	13	25	21	7	0,019	
8	G1/4	7012 06 13	8	17	26,5	22	9,5	0,035	
	G1/8	7012 08 10	5	13	25	26	7	0,019	
8	G1/4	7012 08 13	8	17	26,5	27	9,5	0,036	
	G3/8	7012 08 17	7,5	20	37,5	29	11	0,071	

7061 Regulador compacto alimentación, rosca macho BSPP

Polímero técnico, Latón niquelado, NBR

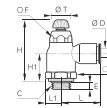

ØD	C		E	F	F1	H	H max	H1	L	L1	ØT	Kg
4	G1/8	7061 04 10	5	10	16	38	44	16	22	9	10	0,020
	G1/8	7061 06 10	5	10	16	38	44	16	22	9	10	0,020
6	G1/4	7061 06 13	5,5	10	16	36,5	42,5	15	22	9	10	0,021
	G1/8	7061 08 10	4,5	14	19	41,5	48	18	28	10,5	14	0,033
8	G1/4	7061 08 13	5,5	14	19	41,5	48	18,5	28	10,5	14	0,034
	G3/8	7061 08 17	5,5	14	23	41,5	48	17	28	11	14	0,033
10	G1/4	7061 10 13	5,5	17	23	45,5	53,5	20	31,5	12,5	17	0,053
	G3/8	7061 10 17	5,5	17	23	45,5	54	20	31,5	12,5	17	0,054
12	G1/2	7061 12 21	7,5	17	24	45,5	54	20	35	13	17	0,060

7060 Regulador compacto escape, rosca macho BSPP

Polímero técnico, Latón niquelado, NBR

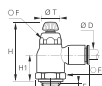

ØD	C		E	F	F1	H	H max	H1	L	L1	ØT	Kg
4	G1/8	7060 04 10	5	10	16	38	44	16	22	9	10	0,020
	G1/8	7060 06 10	5	10	16	38	44	16	22	9	10	0,020
6	G1/4	7060 06 13	5,5	10	16	36,5	42,5	15	22	9	10	0,020
	G1/8	7060 08 10	4,5	14	19	41,5	48	18	28	10,5	14	0,032
8	G1/4	7060 08 13	5,5	14	19	41,5	48	18,5	28	10,5	14	0,034
	G3/8	7060 08 17	5,5	14	19	41,5	48	17	28	11	14	0,034
10	G1/4	7060 10 13	5,5	17	23	45,5	53,5	20	31,5	12,5	17	0,053
	G3/8	7060 10 17	5,5	17	23	45,5	54	20	31,5	12,5	17	0,054
12	G3/8	7060 12 17	5,5	17	23	45,5	54	20	35	12,5	17	0,056
	G1/2	7060 12 21	7,5	17	24	45,5	54	20	35	13	17	0,058

7062 Reguladores compacto bi-direccional, rosca macho BSPP

Polímero técnico, Latón niquelado, NBR

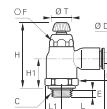

ØD	C		E	F	F1	H	H max	H1	L	L1	ØT	Kg
4	G1/8	7062 04 10	5	10	16	38	44	16	22	9	10	0,025
	G1/8	7062 06 10	5	10	16	38	44	16	22	9	10	0,025
6	G1/4	7062 06 13	5,5	10	16	36,5	42,5	15	22	9	10	0,025
	G1/8	7062 08 10	4,5	14	19	41,5	48	18	28	10,5	14	0,043
8	G1/4	7062 08 13	5,5	14	19	41,5	48	18,5	28	10,5	14	0,046
	G3/8	7062 08 17	5,5	14	19	41,5	48	17	28	11	14	0,042

7065 Regulador compacto escape, rosca macho BSPT

Polímero técnico, Latón niquelado, NBR

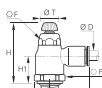

ØD	C		F	F1	H max	H min	H1	L	L1	ØT	Kg
6	R1/8	7065 06 10	10	16	42,5	36,5	15	22	8	10	0,021
	R1/8	7065 08 10	14	19	45	40	16,5	28	10,5	14	0,034
8	R1/4	7065 08 13	14	19	45	40	16,5	28	10,5	14	0,036
	R1/4	7065 10 13	17	23	51,5	43,5	18	31,5	12,5	17	0,053
10	R3/8	7065 10 17	17	23	51,5	43,5	18	31,5	12,5	17	0,055
	R1/2	7065 10 21	17	23	51,5	43,5	18	31,5	12,5	17	0,059
10	R1/4	7065 12 13	17	23	51,5	43,5	18	35	12,5	17	0,056
	R3/8	7065 12 17	17	23	51,5	43,5	18	35	12,5	17	0,059
12	R1/2	7065 12 21	17	23	51,5	43,5	18	35	12,5	17	0,064

Rosca con "pre-coating"

7067 Reguladores compacto bi-direccional, rosca macho BSPT

Polímero técnico, Latón niquelado, NBR

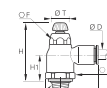

ØD	C		F	F1	H max	H min	H1	L	L1	ØT	Kg
4	R1/8	7067 04 10	10	16	42,5	36,5	14,7	22	9	10	0,025
	R1/8	7067 06 10	10	16	42,5	36,5	14,7	22	9	10	0,010
6	R1/4	7067 06 13	10	16	42,5	36,5	14,7	22	9	10	0,014
	R1/8	7067 08 10	14	19	45	40	16,5	28	10,5	14	0,034
8	R1/4	7067 08 13	14	19	45	40	16,5	28	10,5	14	0,036
	R3/8	7067 08 17	14	19	45	40	16,5	28	11	14	0,042

Rosca con "pre-coating"

Racores reguladores de caudal de polímero / Tornillo exterior



7660 Regulador miniatura escape, rosca macho BSPP y métrica

Polímero técnico, Latón niquelado, NBR

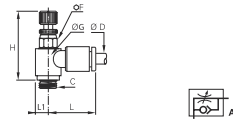

ØD	C		F	G	H max	H min	L	L1	Kg
3	M3x0,5	7660 03 09	6	9	26	23,5	17	4,5	0,007
	M5x0,8	7660 03 19	6	9	26	23,5	17	4,5	0,006
4	M3x0,5	7660 04 09	6	9	26	23,5	16,5	4,5	0,007
	M5x0,8	7660 04 19	6	9	26	23,5	17	4,5	0,006
	G1/8	7660 04 10	7	11,5	29,5	27	18	6	0,012
6	M5x0,8	7660 06 19	6	9	26	23,5	18	4,5	0,006
	G1/8	7660 06 10	7	11,5	29,5	27	18,5	6	0,012
	G1/4	7660 06 13	8	12	32,5	30	19	6	0,019
8	G1/8	7660 08 10	13	14	31	26,5	26	7	0,021
	G1/4	7660 08 13	16	19	34	29	27,5	9,5	0,033
	G3/8	7660 08 17	20	23	42	36	29	11,5	0,061

7668 Regulador miniatura alimentación, rosca macho BSPT

Polímero técnico, Latón niquelado, NBR

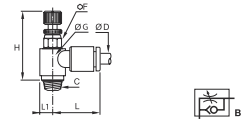

ØD	C		F	G	H max	H min	L	L1	Kg
4	R1/8	7668 04 10	7	11,5	28,5	25,5	18	6	0,011
	R1/8	7668 06 10	7	11,5	29	24	18,5	6	0,012
6	R1/4	7668 06 13	8	13,5	31	27	19	7	0,019
	R1/8	7668 08 10	13	14	28,5	25	26	7	0,020
	R1/4	7668 08 13	16	19	30	26	27,5	9,5	0,032

Rosca con "pre-coating"

7662 Regulador miniatura bi-direccional, rosca macho BSPP y métrica

Polímero técnico, Latón niquelado, NBR

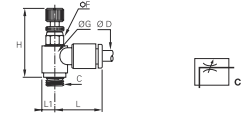

ØD	C		F	G	H max	H min	L	L1	Kg
4	M5x0,8	7662 04 19	6	9	26	23,5	17	4,5	0,007
	G1/8	7662 04 10	7	11,5	29,5	27	18	6	0,013
6	M5x0,8	7662 06 19	6	9	26	23,5	18	4,5	0,010
	G1/8	7662 06 10	7	11,5	29,5	27	18,5	6	0,013
	G1/4	7662 06 13	8	12	32,5	30	19	6	0,019

7665 Regulador miniatura escape, rosca macho BSPT

Polímero técnico, Latón niquelado, NBR

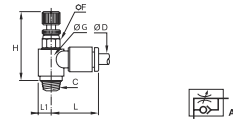

ØD	C		F	G	H max	H min	L	L1	Kg
4	R1/8	7665 04 10	7	11,5	27,5	25	18	6	0,012
	R1/8	7665 06 10	7	11,5	27,5	25	18,5	6	0,012
6	R1/4	7665 06 13	8	13,5	30	27,5	19	7	0,019
	R3/8	7665 06 17	17	13,5	34	31,5	19	7	0,025
	R1/8	7665 08 10	13	14	28,5	24	26	7	0,021
8	R1/4	7665 08 13	16	19	29	25	27,5	9,5	0,033
	R3/8	7665 08 17	20	23	36	30	29	11,5	0,061

Rosca con "pre-coating"

7669 Regulador miniatura alimentación, rosca macho BSPP y métrica

Polímero técnico, Latón niquelado, NBR

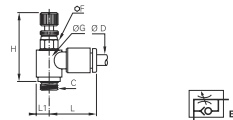

ØD	C		F	G	H max	H min	L	L1	Kg
3	M3x0,5	7669 03 09	6	9	26,5	24	17	4,5	0,008
	M5x0,8	7669 03 19	6	9	27,5	25	17	4,5	0,007
4	M5x0,8	7669 04 19	6	9	27,5	25	17	4,5	0,006
	G1/8	7669 04 10	7	11,5	31	28	18	6	0,012
6	M5x0,8	7669 06 19	6	9	27	23,5	18	4,5	0,007
	G1/8	7669 06 10	7	11,5	31	28	18,5	6	0,012
	G1/4	7669 06 13	8	12	34	30,5	19	6	0,019
8	G1/8	7669 08 10	13	14	32	29	26	7	0,021
	G1/4	7669 08 13	16	19	33,5	29,5	27,5	9,5	0,032
	G3/8	7669 08 17	20	23	41	37	29	11,5	0,063

Racores reguladores de caudal de polímero / Tornillo exterior

7040 Regulador compacto orientable escape, rosca macho BSPP

Polímero técnico, Latón niquelado, NBR

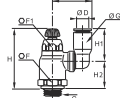

ØD	C	F	F1	G	H max	H min	H1	H2	L	Kg
6	G1/8 7040 06 10	16	10	10,5	44	38	16	18	23,5	0,024
	G1/4 7040 06 13	16	10	10,5	42,5	36,5	16	16,5	23,5	0,023
8	G1/8 7040 08 10	19	14	13,5	48	41,5	23	19	28	0,037
	G1/4 7040 08 13	19	14	13,5	48	41,5	23	19,5	28	0,039
10	G3/8 7040 08 17	19	14	13,5	48	41,5	23	17,5	28	0,020
	G1/4 7040 10 13	23	17	16	53,5	45,5	26,5	21	35	0,051
12	G3/8 7040 10 17	23	17	16	54	45,5	26,5	21,5	35	0,063
	G3/8 7040 12 17	23	17	19	54	45,5	30,5	21,5	38	0,066
12	G1/2 7040 12 21	24	17	19	54	45,5	30,5	21	38	0,071

7045 Regulador compacto orientable escape, rosca macho BSPT

Polímero técnico, Latón niquelado, NBR

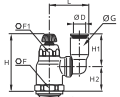

ØD	C	F	F1	G	H max	H min	H1	H2	L	Kg
10	R3/8 7045 10 17	23	17	16	51,5	43,5	26,5	19	35	0,065
12	R3/8 7045 12 17	23	17	19	51,5	43,5	31	19	38	0,065

Rosca con "pre-coating"

7640 Regulador miniatura orientable escape, rosca macho BSPP y métrica

Polímero técnico, Latón niquelado, NBR

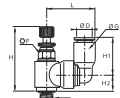

ØD	C	F	F1	G	H max	H min	H1	H2	L	Kg
4	M5x0,8 7640 04 19	6	8,5	26	23,5	14	6,5	19,5	0,011	
	G1/8 7640 04 10	7	8,5	29,5	27	14	8	19,5	0,015	
6	M5x0,8 7640 06 19	6	10,5	26	23,5	16	6,5	21	0,001	
	G1/8 7640 06 10	7	10,5	29,5	27	16	8	20,5	0,015	

7649 Regulador miniatura orientable alimentación, rosca macho BSPP y métrica

Polímero técnico, Latón niquelado, NBR

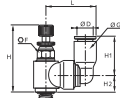

ØD	C	F	F1	G	H max	H min	H1	H2	L	Kg
4	M5x0,8 7649 04 19	6	8,5	27	24	14	6,5	19	0,015	
	M5x0,8 7649 06 19	6	10,5	27	24	16	6,5	21	0,008	
6	G1/8 7649 06 10	7	10,5	30,5	28	16	8,5	21,5	0,015	

7770 Regulador en línea unidireccional

Polímero técnico, Latón niquelado, NBR



ØD	F	H max	H min	K	L	L1	N	N1	ØT	Kg	
4	7770 04 00	5	33,5	29,5	12	36	15	11	8	2,2	0,009
6	7770 06 00	8	44,5	40,5	17	51	23	17	11	3,2	0,024
8	7770 08 00	11	52,5	46,5	18,5	58	26	20	12,5	3,2	0,048
10	7770 10 00	14	61	53	24	73	33	26	16	4,2	0,097
12	7770 12 00	14	67,5	59	28	85	35	27,5	20	4,2	0,132

7772 Regulador en línea bi-direccional

Polímero técnico, Latón niquelado, NBR



ØD	F	H max	H min	K	L	L1	N	N1	ØT	Kg	
4	7772 04 00	5	33,5	29,5	12	36	15	11	8	2,2	0,009
6	7772 06 00	8	44,5	40	17	51	23	17	11	3,2	0,024
8	7772 08 00	11	52,5	46,5	18,5	58	26	20	12,5	3,2	0,054

7776 Regulador en línea unidireccional pasatabiques

Polímero técnico, Latón niquelado, NBR



ØD	F	F1	H	H max	H1	H2	K	L	ØT	Kg	
4	7776 04 00*	14	24	27	6,5	11	6	36	10,5	0,015	
6	7776 06 00*	19	27,5	31	7,5	13,5	7	51	16,5	0,038	
8	7776 08 00	24	11	28,5	34,5	9	13,5	7	58	18,5	0,069
10	7776 10 00	30	14	29,5	38,5	11,5	13,5	7	73	24,5	0,136
12	7776 12 00	32	14	32	42	12,5	15,5	8	85	27,5	0,185

*Modelos de micro-regulación

7771 Regulador en línea unidireccional, rosca hembra BSPP

Polímero técnico, Latón niquelado, NBR



C	F	F1	H max	H min	L	L1	N	N1	ØT	Kg
G1/8 7771 10 10	13	8	44,5	39,5	68,5	23	17	11	3,2	0,043
G1/4 7771 13 13	16	11	50	44	83	26	20	12,5	3,2	0,103
G3/8 7771 17 17	19	14	61	52	97	33	26	16	4,2	0,160
G1/2 7771 21 21	24	14	67,5	57,5	121	35	27,5	20	4,2	0,260

Racores reguladores de caudal de polímero / Tornillo exterior

7000 Agrafes de unión

Polímero técnico



ØD		Kg
4	7000 00 04	0,001
6-8	7000 00 05	0,005
10-12	7000 00 06	0,001

Usar con 7770, 7771, 7772 y 7776.

7020 Regulador rector escape, rosca macho BSPB

Polímero técnico, Latón niquelado, NBR

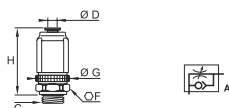

ØD	C		F	G	H max	H min	Kg
8	G1/8	7020 08 10	24	27	52,5	46,5	0,110

7030 Regulador compacto escape enclavable

Polímero técnico, Latón niquelado, NBR

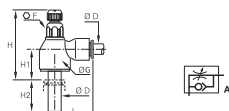

ØD		F	G	H max	H min	H1	H2	L	Kg
6	7030 06 00	10	16	41	35	14	17	22	0,013
8	7030 08 00	14	19	46,5	39,5	16	21,5	28	0,022
12	7030 12 00	17	23	51	43	17	27	35	0,044

7031 Regulador compacto alimentación enclavable

Polímero técnico, Latón niquelado, NBR

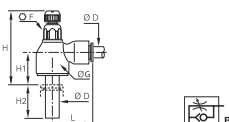

ØD		F	G	H max	H min	H1	H2	L	Kg
6	7031 06 00	10	16	41	35	14	17	22	0,013
8	7031 08 00	14	19	46,5	39,5	16	21,5	28	0,035

7630 Regulador miniatura escape enclavable

Polímero técnico, Latón niquelado, NBR

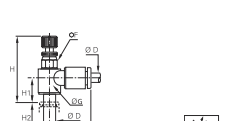

ØD		F	G	H max	H min	H1	H2	L	Kg
4	7630 04 00	6	9	28	25,5	9,5	15,5	17	0,007
6	7630 06 00	7	11,5	29	27,5	10,5	17	18,5	0,012

7631 Regulador miniatura alimentación enclavable

Polímero técnico, Latón niquelado, NBR

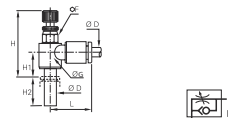

ØD		F	G	H max	H min	H1	H2	L	Kg
4	7631 04 00	6	9	28	25,5	9,5	15,5	17	0,007
6	7631 06 00	7	11,5	29	27,5	10,5	17	18,5	0,011

Racores reguladores de caudal metálicos / Tornillo oculto

7130 Regulador escape, rosca macho BSPP y métrica

Latón niquelado, NBR

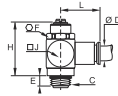

ØD	C		E	F	H	J	L	Kg
4	M5x0,8	7130 04 19	4	8	17	9	19	0,010
	G1/8	7130 04 10	5	13	29	15	20	0,037
6	M5x0,8	7130 06 19	4	8	17	9	24	0,013
	G1/8	7130 06 10	5	13	29	15	22	0,038
	G1/4	7130 06 13	8	17	31	18	24	0,062
8	G1/8	7130 08 10	5	13	29	15	25	0,042
	G1/4	7130 08 13	8	17	31	18	28	0,066
	G3/8	7130 08 17	7	20	40	21,5	29	0,109
10	G1/4	7130 10 13	8	17	31	18	30	0,075
	G3/8	7130 10 17	7	20	40	21,5	32	0,119
	G1/2	7130 10 21	8	23	53	28	34	0,227
12	G3/8	7130 12 17	7	20	40	22	36	0,064
	G1/2	7130 12 21	8	23	53	28	38	0,306

7140 Regulador escape, rosca macho y hembra BSPP y métrica

Latón niquelado, NBR

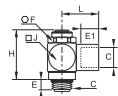

C		E	E1	F	H	J	L	Kg
M5x0,8	7140 19 19	4	4	8	21	9	11	0,009
G1/8	7140 10 10	5	8	13	32	15	17	0,039
G1/4	7140 13 13	8	12	17	39	18	24	0,073
G3/8	7140 17 17	7	12	20	47	21,5	27	0,124
G1/2	7140 21 21	8	15	23	61	28	31	0,238

7160 Regulador escape de conexión universal, rosca macho BSPP

Latón niquelado, NBR

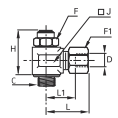

ØD	C		F	F1	H	J	L	L1	Kg
4	G1/8	7160 04 10	13	10	26	17	25,5	14,5	0,051
	G1/8	7160 06 10	13	13	26	17	25,5	14,5	0,054
6	G1/4	7160 06 13	17	13	31,5	22	28,5	17,5	0,101
	G1/8	7160 08 10	13	14	26	17	29,5	15,5	0,055
8	G1/4	7160 08 13	17	14	31,5	22	31	17	0,101
	G1/4	7160 10 13	17	19	31,5	22	35	19	0,117
10	G3/8	7160 10 17	20	19	44,5	22	37,5	19	0,190
	G1/2	7160 10 21	23	19	50	27	37,5	19	0,204
12	G1/2	7160 12 21	23	22	50	27	38	21,5	0,212

Racores reguladores de caudal metálicos / Tornillo exterior



7100 Regulador compacto escape, rosca macho BSPP

Latón niquelado, NBR

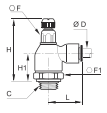

ØD	C	F	F1	H max	H min	H1	L	Kg
4	G1/8 7100 04 10	10	19	53	47	23	21	0,080
	G1/8 7100 06 10	10	19	53	47	23	24,5	0,082
6	G1/4 7100 06 13	10	19	53	47,5	23,5	24,5	0,085
	G1/8 7100 08 10	14	19	55	50	24,5	29	0,097
8	G1/4 7100 08 13	14	19	56	50	25	29	0,101
	G3/8 7100 08 17	17	25	62	56	27	30,5	0,154
10	G1/4 7100 10 13	14	19	56	50	25	35	0,106
	G3/8 7100 10 17	17	25	62	56	27	35	0,157
12	G3/8 7100 12 17	17	25	62	56	27	38	0,198
	G1/2 7100 12 21	17	25	62	55	27	38	0,207
14	G1/2 7100 14 21	17	25	62	55	27	41	0,205

7180 Regulador miniatura escape, rosca macho BSPP y métrica

Latón niquelado, NBR

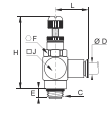

ØD	C	E	F	H max	H min	J	L	Kg
4	M5x0,8 7180 04 19	4	8	29	24	10	19	0,012
	G1/8 7180 04 10	5	13	44	39	15	20	0,041
6	M5x0,8 7180 06 19	4	8	29	24	10	24	0,015
	G1/8 7180 06 10	5	13	44	39	15	22	0,043
8	G1/8 7180 08 10	5	13	44	39	15	26	0,049

7101 Regulador compacto alimentación, rosca macho BSPP

Latón niquelado, NBR

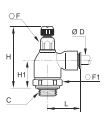

ØD	C	F	F1	H max	H min	H1	L	Kg
4	G1/8 7101 04 10	10	19	53	47	23	21	0,096
	G1/8 7101 06 10	10	19	53	47	23	24,5	0,081
6	G1/4 7101 06 13	10	19	53	47,5	23,5	24,5	0,084
	G1/8 7101 08 10	14	19	55	50	24,5	29	0,097
8	G1/4 7101 08 13	14	19	56	50	25	29	0,101
	G3/8 7101 08 17	17	25	62	56	27	30,5	0,155

7110 Regulador compacto escape, rosca macho y hembra BSPP

Latón niquelado, NBR

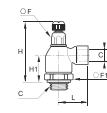

C	F	F1	H max	H min	H1	L	Kg
G1/8 7110 10 10	10	19	52,5	47	23	22,5	0,080
G1/4 7110 13 13	14	19	55,5	50,5	25	32	0,107
G3/8 7110 17 17	17	25	62	56	27	34,5	0,212
G1/2 7110 21 21	17	25	62	55	27	37,5	0,191

7680 Regulador compacto escape, rosca macho BSPP

Latón niquelado, NBR

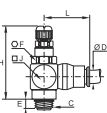

ØD	C	E	F	H max	H min	J	L	Kg
6	G1/8 7680 06 10	5	13	44	39	7,5	24,5	0,045
	G1/8 7680 08 10	5	13	44	39	7,5	24,5	0,047
8	G1/4 7680 08 13	8	17	47	41	9	27	0,076
10	G3/8 7680 10 17	7	20	60	50	11	34	0,133
12	G1/2 7680 12 21	8	23	77	65	14	36,5	0,165

7190 Regulador miniatura escape, rosca macho y hembra BSPP y métrica

Latón niquelado, NBR

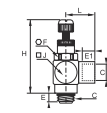

C	E	E1	F	H max	H min	J	L	Kg
M5x0,8 7190 19 19	4	4	8	29	24	10	11	0,012
G1/8 7190 10 10	5	8	13	44	39	15	17	0,044

01 // Racores

Racores con funciones

Racores reguladores de caudal

Racores reguladores de caudal metálicos / Tornillo exterior

7170 Regulador en línea de aluminio, rosca hembra metrica y BSPP

Aluminio tratado, NBR, Latón

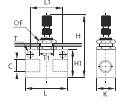

C		F	H max	H min	H1	K	L	L1	ØT	Kg
M5x0,8	7170 19 19	12	42	38	15	12	25	18	4,5	0,021
G1/8	7170 10 10	15	56	49	22	18	35	24,7	4,5	0,056
G1/4	7170 13 13	15	64	57	30	20	46	35	6,5	0,088
G3/8	7170 17 17	22	73	62	30	25	50	35	6,5	0,154
G1/2	7170 21 21	22	83	72	40	25	60	44	6,5	0,195

Racores reguladores de caudal de acero inoxidable



Con su cuerpo de acero inoxidable 316L y su tornillo de regulación, esta gama combina la precisión de regulación, la exactitud y la compacidad para aplicaciones en entornos sometidos a tensiones mecánicas o químicas importantes.

Características técnicas

Fluidos adecuados	Aire comprimido 7822: todos los fluidos compatibles según el tipo de juntas FKM o PTFE
Presión de trabajo	7810-7812: 1 a 10 bar 7820: 1 a 16 bar 7822: 1 a 40 bar
Temperatura de trabajo	7810 – 7812: 0°C a +70°C 7820 – 7822: -15° a +120°C

Ventajas

- Compatibilidad con entornos agresivos, mecánicos y químicos

Para aplicaciones en procesos alimentarios:

- Garantía de la integridad de los fluidos transportados
- Formas exteriores fáciles de limpiar

Materiales

Componentes externos

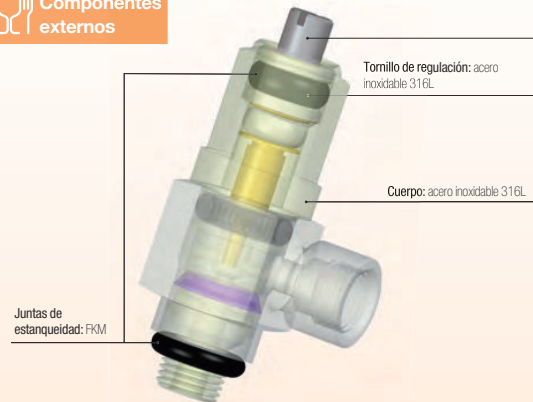

Reglamentaciones

- RoHS
- REACH
- PED
- FDA: 21 CFR
- 1935/2004

Principio de funcionamiento

Modelo con tornillo exterior en el escape

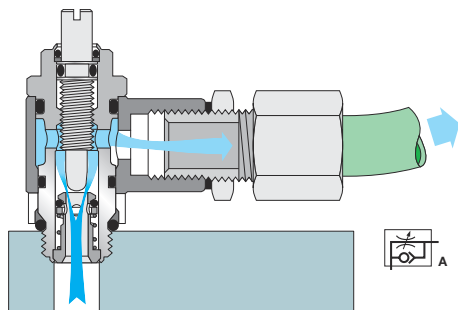

Modelo con tornillo exterior bidireccional

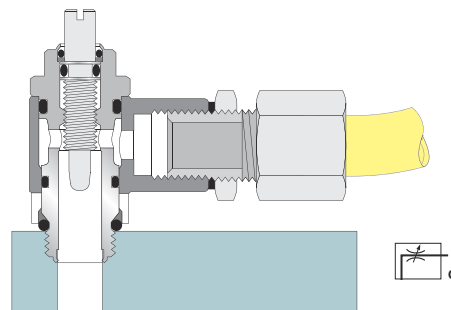

7810 Regulador escape, rosca macho y hembra BSPP y métrica

Acero inox 316L, FKM

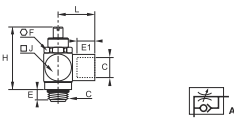

C	E	E1	F	H max	H min	J	L	Kg	
M5x0,8	7810 19 19	4	4	8	26	22	9	11	0,011
G1/8	7810 10 10	6	8	13	38	32	15	17	0,039
G1/4	7810 13 13	9	12	17	40	35	18	24	0,072
G3/8	7810 17 17	8	12	20	53	43	22	27	0,126
G1/2	7810 21 21	9	15	23	71	60	28	31	0,261

7812 Regulador bi-direccional, rosca macho y hembra BSPP y métrica

Acero inox 316L, FKM

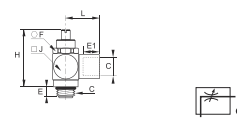



C	E	E1	F	H max	H min	J	L	Kg	
M5x0,8	7812 19 19	4	4	8	26	22	9	11	0,011
G1/8	7812 10 10	6	8	13	38	32	15	17	0,040
G1/4	7812 13 13	9	12	17	40	35	18	24	0,074
G3/8	7812 17 17	8	12	20	53	43	22	24	0,125
G1/2	7812 21 21	9	15	23	71	60	28	31	0,261

Racores reguladores de caudal / Acero inoxidable

7820 Regulador en línea uni-direccional, rosca hembra BSPP

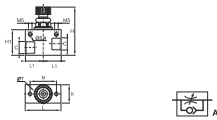
Acero inox 316L, FKM



DN	C		H max	H min	H1	K	L	L1	N	ØT	Kg
7	G1/8	7820 00 10	52,5	47	30	20	40	20	30	20	0,174
7	G1/4	7820 00 13	52,5	47	30	20	40	20	30	20	0,164
9	G3/8	7820 00 17	65	56	35	25	50	25	36	20	0,285
12	G1/2	7820 00 21	65	58	35	25	50	25	36	20	0,305

7822 Regulador en línea uni-direccional, rosca hembra BSPP

Acero inox 316L, FKM

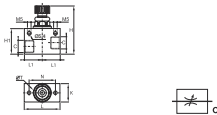

DN	C		H max	H min	H1	K	L	L1	N	ØT	Kg
7	G1/8	7822 00 10	52,5	48	30	20	40	20	30	20	0,176
7	G1/4	7822 00 13	52,5	48	30	20	40	20	30	20	0,164
9	G3/8	7822 00 17	65	58	35	25	50	25	36	20	0,289
12	G1/2	7822 00 21	87	76	40	30	60	30	42	30	0,265

Características de caudal (a 6 bar) de los racores reguladores de caudal



7010
7011
7012

7010

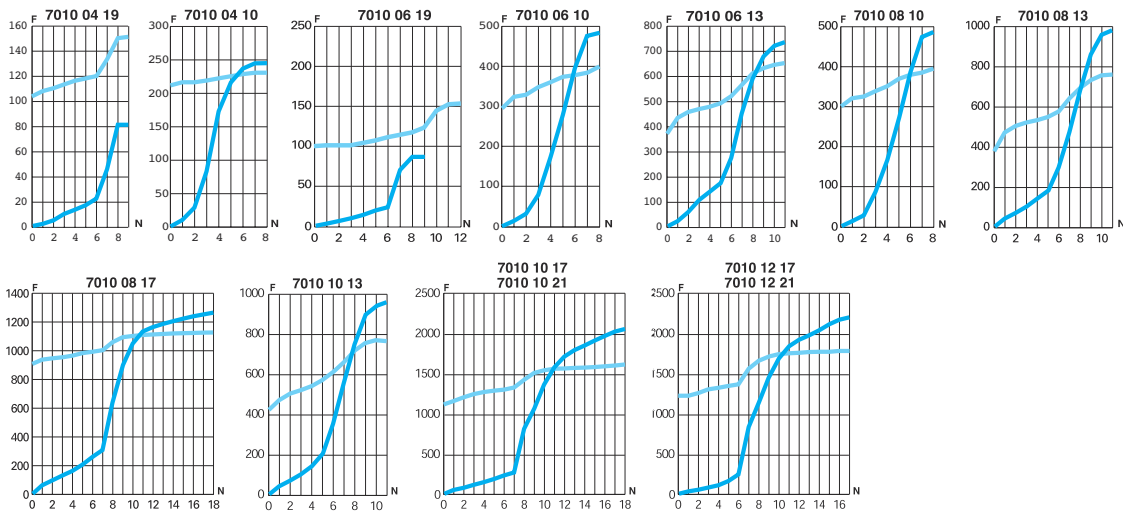

7011

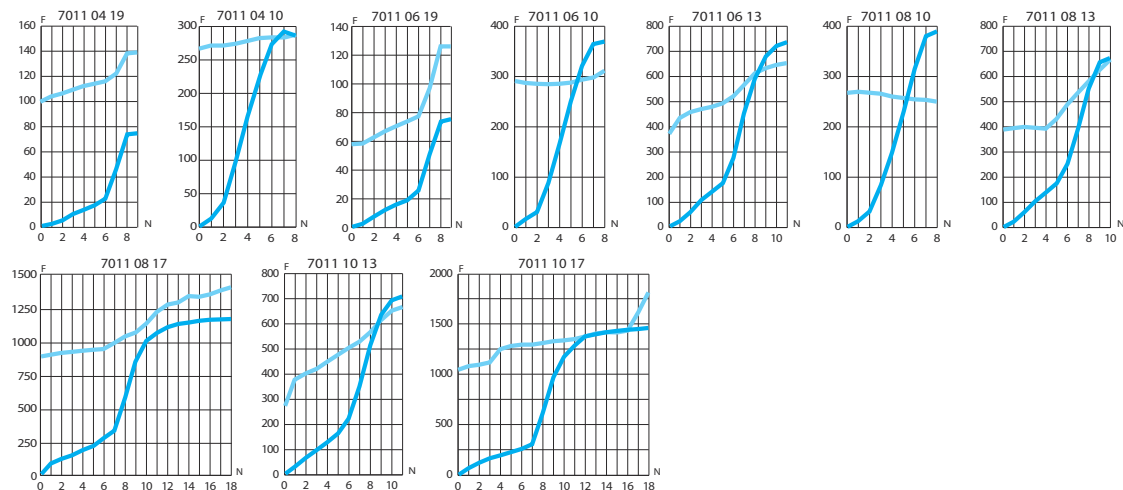

7012

Características de los caudales del modelo 7012:

- en escape (ver modelo 7010, sentido regulación)
- en alimentación (ver modelo 7011, sentido regulación)

6 bar

 Sentido regulación
 Sentido retorno

F: Caudal en NI/min

N: Número de vueltas de regulación

Características de caudal (a 6 bar) de los racores reguladores de caudal



**7060
7061
7062**

7060

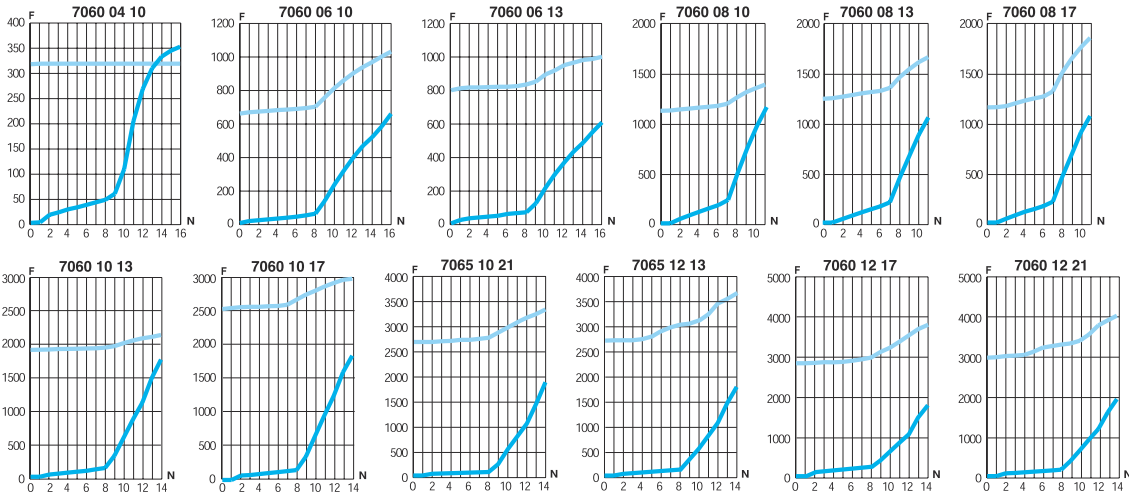

7061

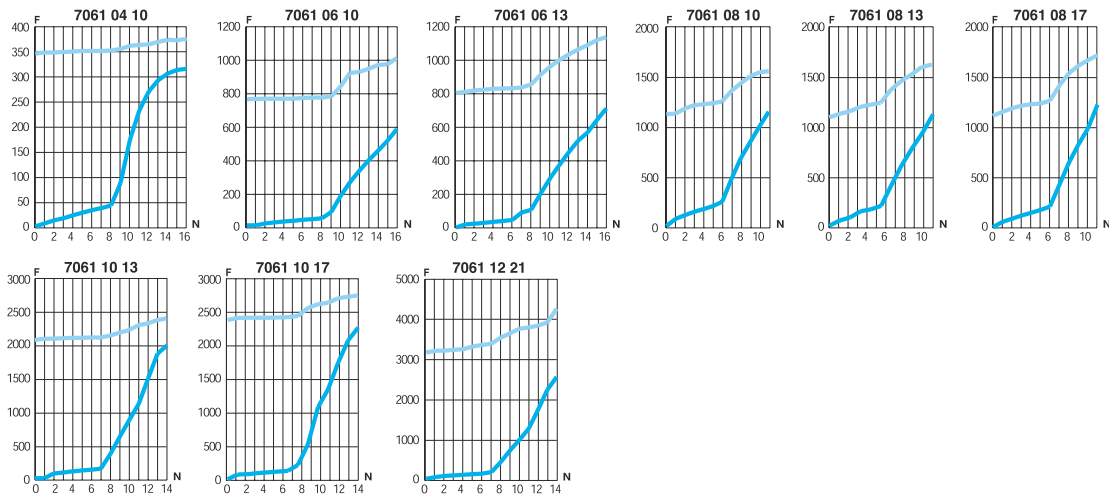

7062

Características de los caudales del modelo 7062:

- en escape (ver modelo 7060, sentido regulación)
- en alimentación (ver modelo 7061, sentido regulación)

Características de caudal (a 6 bar) de los racores reguladores de caudal



01 // Racores

Racores con funciones

Racores reguladores de caudal



7660
7669
7662

7660

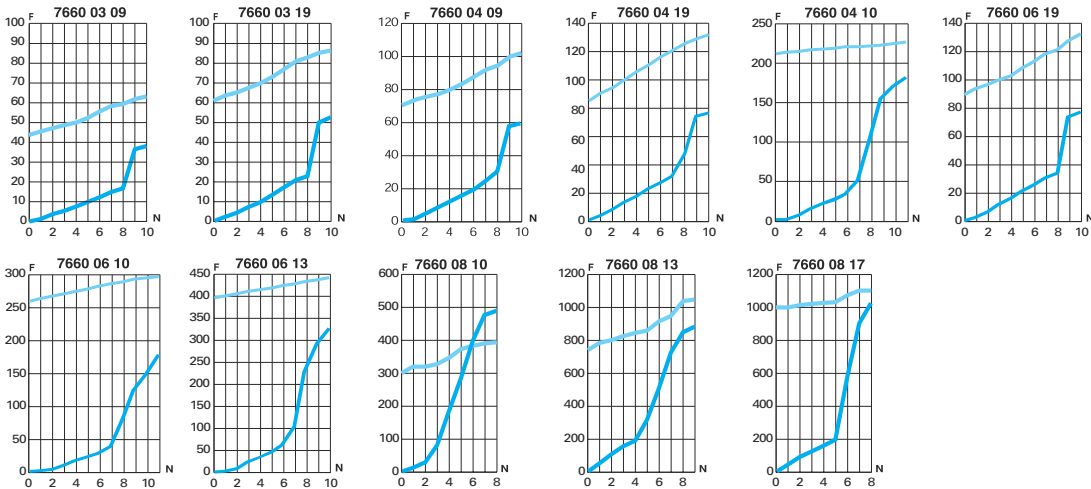

7669

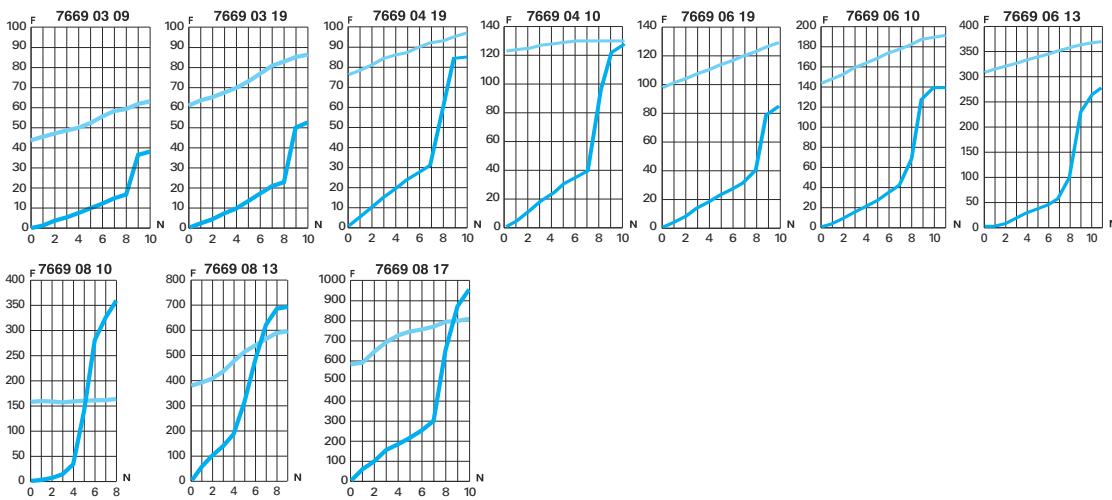

7662

Características de los caudales del modelo 7662:

- en escape: ver modelo 7660, sentido regulación
- en alimentación: ver modelo 7669, sentido regulación

6 bar

 Sentido regulación
 Sentido retorno

F: Caudal en Nl/min

N: Número de vueltas de regulación

Características de caudal (a 6 bar) de los racores reguladores de caudal



**7640
7649**

7640

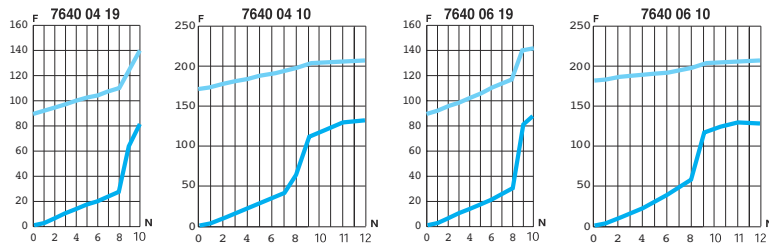

7649

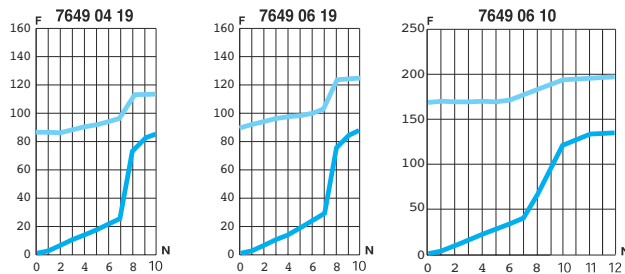

7771

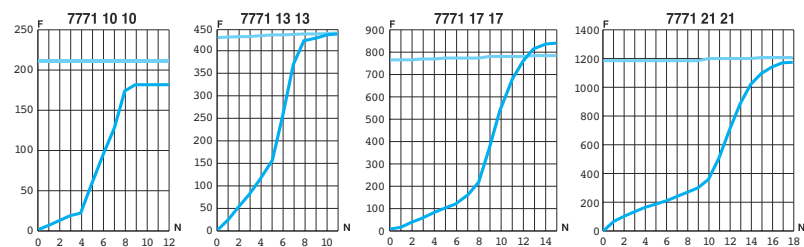

7020

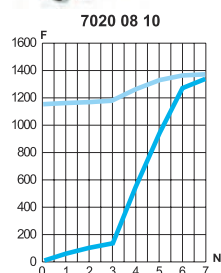

Características de caudal (a 6 bar) de los racores reguladores de caudal



7770

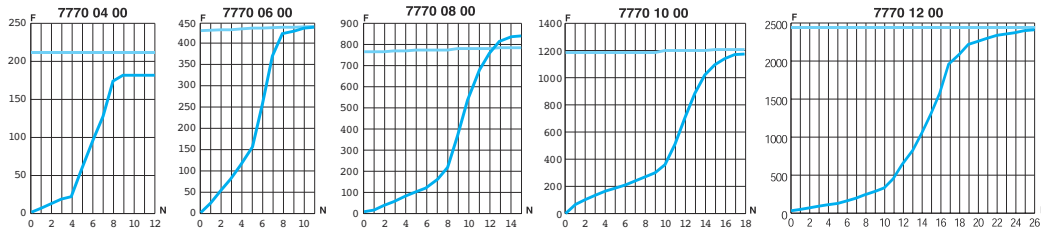

7776

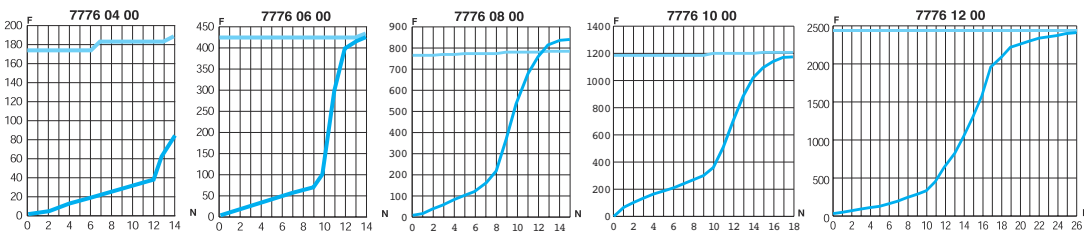

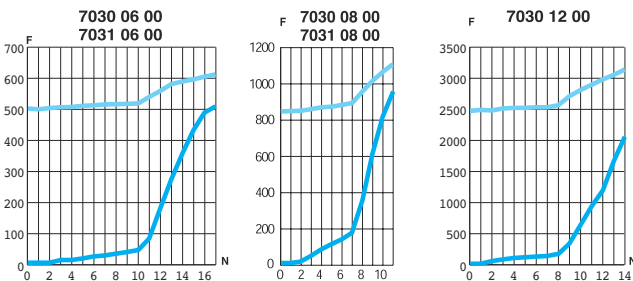

**7030
7031**

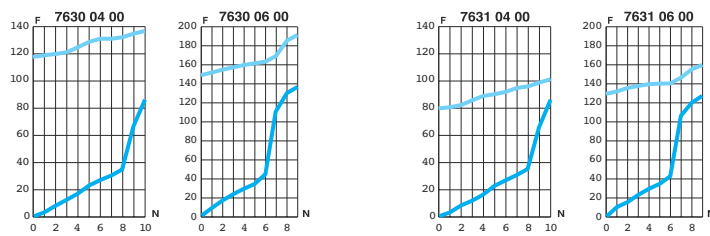

**7630
7631**



6 bar
 Sentido regulación
 Sentido retorno
F: Caudal en NI/min
N: Número de vueltas de regulación

Características de caudal (a 6 bar) de los racores reguladores de caudal



**7065
7067**

7065

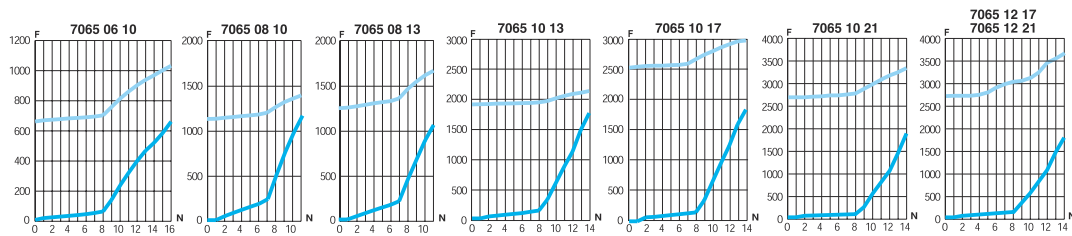

7067

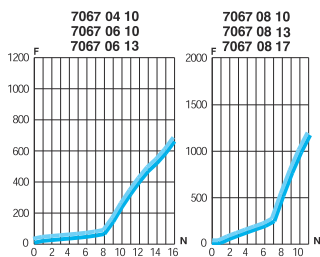

**7665
7668**

7665

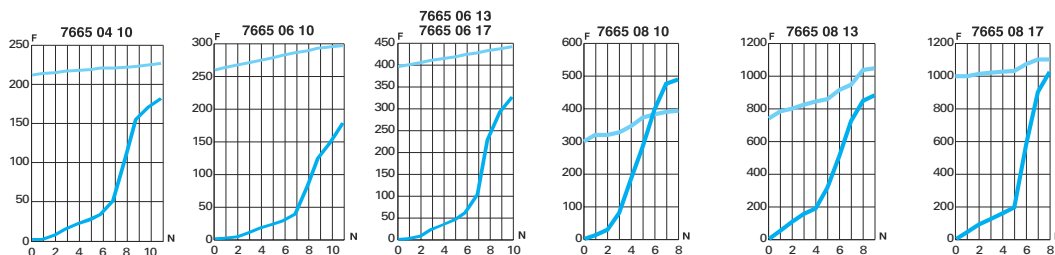

7668

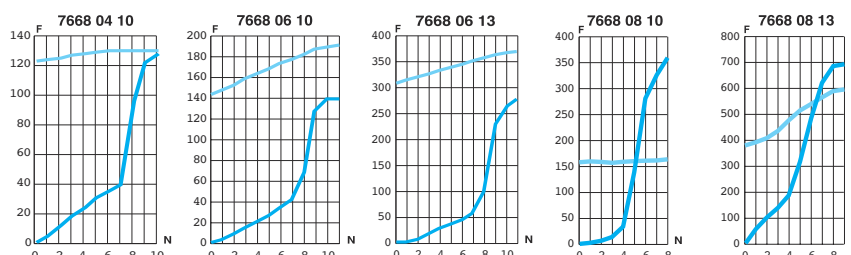

Características de caudal (a 6 bar) de los racores reguladores de caudal



7045

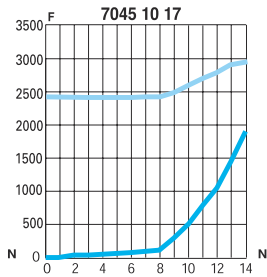

7130

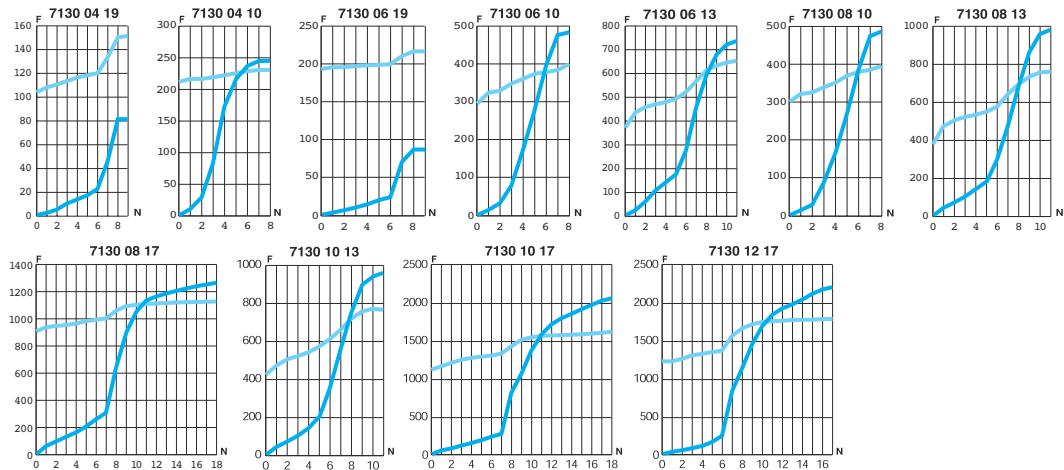

6 bar

 Sentido regulación
 Sentido retorno

F: Caudal en NI/min

N: Número de vueltas de regulación

Características de caudal (a 6 bar) de los racores reguladores de caudal



7140

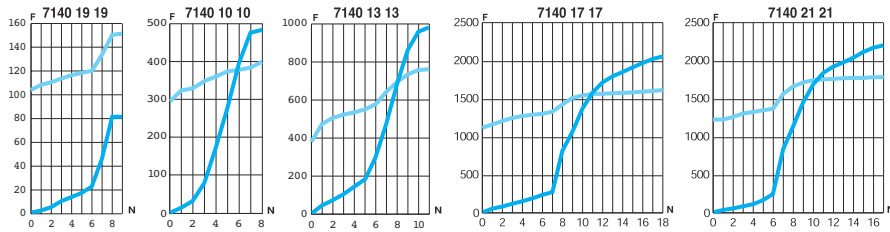

7160

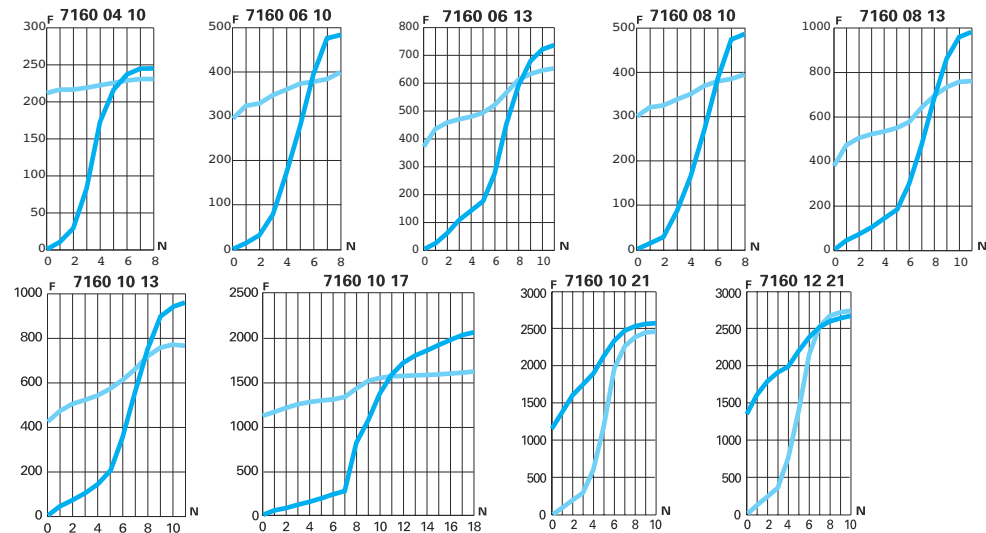

Características de caudal (a 6 bar) de los racores reguladores de caudal



**7100
7101**

7100

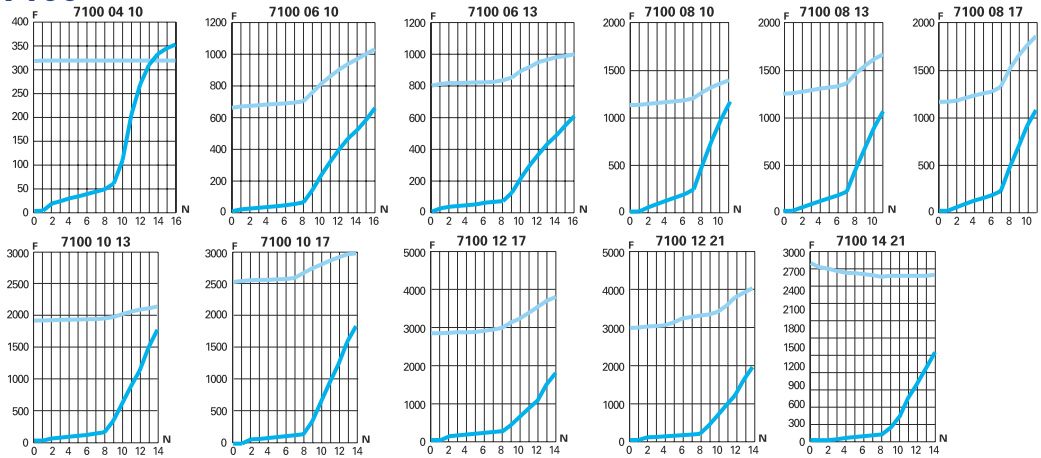

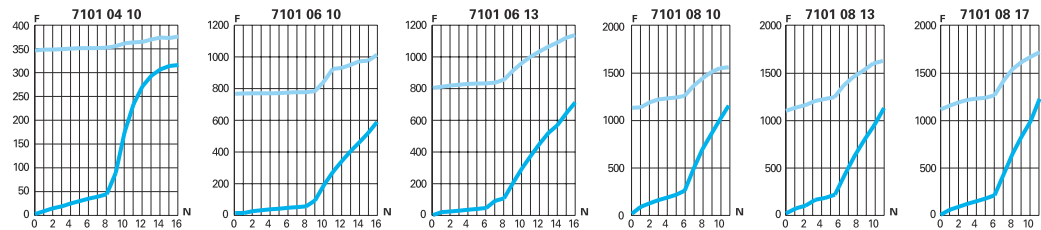

7101

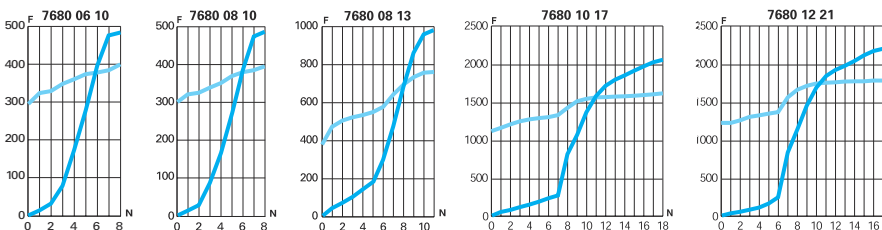

7680



6 bar

 Sentido regulación
 Sentido retorno
F: Caudal en NI/min
N: Número de vueltas de regulación

Características de caudal (a 6 bar) de los racores reguladores de caudal



7180

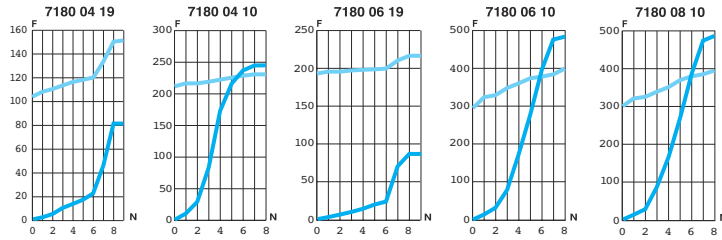

7110 7111

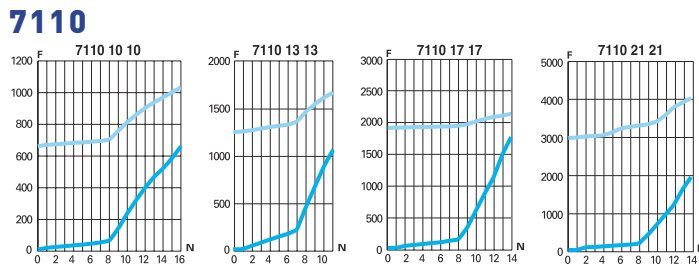

7111

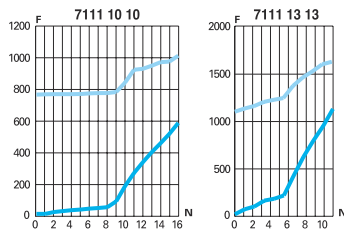

7170

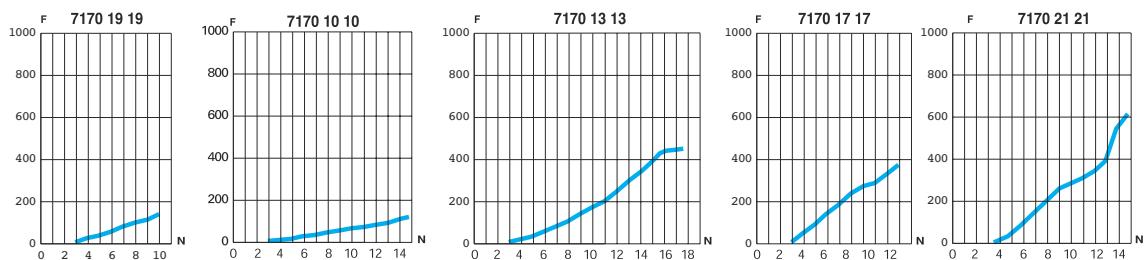

Racores de bloqueo



Cuando se retira el umbral de pilotaje, estos accesorios garantizan la seguridad de los operadores y protegen la instalación cortando el suministro de aire comprimido en el circuito.

Ø métrico:
4 a 12 mm

Características técnicas

- **Fluidos adecuados:** aire comprimido
- **Presión de trabajo:** 1 a 10 bar
- **Temperatura de trabajo:** -20°C a +70°C
-25°C a +70°C (versión de metal)

Modelo	Caudal de alimentación 6 bar	Umbral de pilotaje y despilotaje según presión de alimentación	Umbral de pilotaje y despilotaje según presión de alimentación					
			2 bar	4 bar	6 bar	8 bar	10 bar	
ØD 6 y 8 mm, roscas G1/8, G1/4, R1/8, R1/4	650NI /min	Pilotaje	2,40	2,90	3,30	3,60	4,00	
	650NI /min	Despilotaje	1,50	1,80	2,15	2,40	2,80	
ØD 10 y 12 mm, G1/2, R3/8, R1/2	1600NI /min	Pilotaje	2,70	3,20	3,50	3,80	4,10	
	1600NI /min	Despilotaje	1,40	1,80	2,10	2,40	2,70	

Las prestaciones dependen de los fluidos, del material y del tubo utilizados. El uso está garantizado para un vacío de 755 mm Hg (99% de vacío).

Materiales

Sin silicona

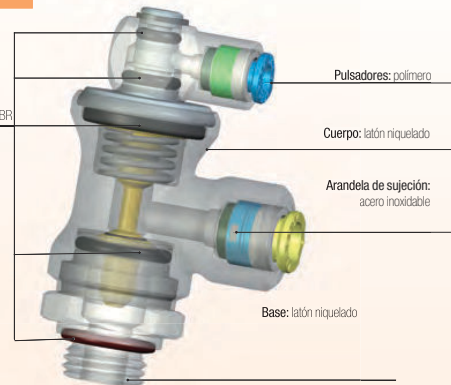

Ventajas

- Se montan siempre dos por cilindro
- Dimensiones reducidas
- Durabilidad testada según exigencias de DI 2006/42/EC (B10d = 10 000 000 de ciclos a una frecuencia de 1Hz, según ISO 19973)
- Orientabilidad total que facilita el cableado para adaptarse a cualquier configuración
- Excelente resistencia a las nieblas salinas y a las chispas

Regulaciones

- RoHS
- PED
- REACH
- B10d >110 millones de ciclos

Principio de funcionamiento

Cilindro en movimiento (pilotado)

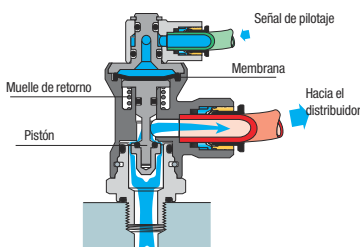

Señal de autorización de movimiento de pilotaje

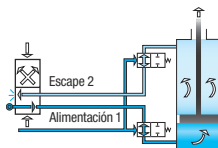

Cilindro bloqueado (despilotado)

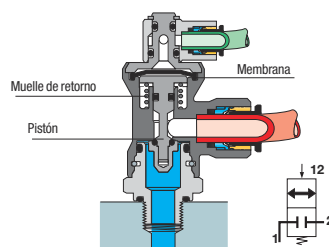

Señal de autorización de movimiento de despilotaje

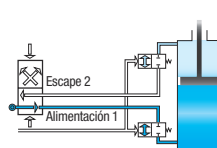

Instalación

Montados por parejas, los racores de bloqueo se instalan directamente sobre el cilindro. Su total orientabilidad confiere una gran flexibilidad para la realización de circuitos neumáticos.

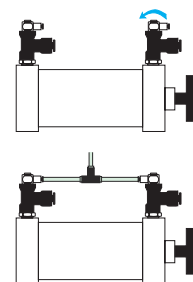

Racores de bloqueo

7880 Racor de bloqueo, rosca macho BSPP

Latón niquelado, NBR

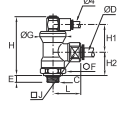

ØD	C		E	F	G	H	H1	H2	J	L	Kg
6	G1/8	7880 06 10	5,5	21	24	53	24,5	21	17	28	0,127
	G1/4	7880 06 13	6,5	21	24	53	24,5	21	17	28	0,130
8	G1/4	7880 08 13	6,5	21	24	53	24,5	21	17	28	0,124
	G3/8	7880 08 17	7,5	21	24	53	24,5	21	17	28	0,127
10	G3/8	7880 10 17	7,5	24	28	58	25	25	27	35	0,210
12	G1/2	7880 12 21	9	24	28	58	25	25	27	37,5	0,220

7881 Racor de bloqueo, rosca macho / hembra BSPP

Latón niquelado, NBR

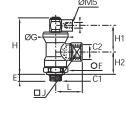

C1	C2		E	F	G	H	H1	H2	J	L	Kg
G1/8	G1/4	7881 13 10	5,5	21	24	53	24,5	21	17	25,5	0,119
G1/4	G1/4	7881 13 13	6,5	21	24	53	24,5	21	17	25,5	0,120
G3/8	G3/8	7881 17 17	7,5	24	28	58	25	25	27	34	0,208
G1/2	G1/2	7881 21 21	9	24	28	58	25	25	27	40	0,221

7885 Racor de bloqueo, rosca macho BSPT

Latón niquelado, NBR

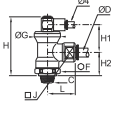

ØD	C		F	G	H	H1	H2	J	L	Kg
6	R1/8	7885 06 10	21	24	51,5	25	20	17	28	0,127
	R1/4	7885 06 13	21	24	51,5	25	20	17	28	0,131
8	R1/4	7885 08 13	21	24	51,5	25	20	17	28	0,126
	R3/8	7885 08 17	21	24	51,5	25	20	17	28	0,131
10	R3/8	7885 10 17	24	28	57	25	24	27	35	0,217
12	R1/2	7885 12 21	24	28	57	25	24	27	37,5	0,229

Rosca con "pre-coating"

7886 Racor de bloqueo, rosca macho / hembra BSPT

Latón niquelado, NBR

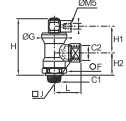

C1	C2		F	G	H	H1	H2	J	L	Kg
R1/8	R1/4	7886 13 10	21	24	51,5	25	20	17	26,5	0,121
R1/4	R1/4	7886 13 13	21	24	51,5	25	20	17	26,5	0,126
R3/8	R3/8	7886 17 17	24	28	57	25	24	27	34	0,225
R1/2	R1/2	7886 21 21	24	28	57	25	24	27	40	0,235

Rosca con "pre-coating"

7883 Racor de bloqueo-regulador de caudal, rosca macho BSPP

Latón niquelado, Polímero técnico, NBR

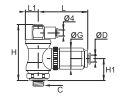

ØD	C		G	H	H1	L	L max	L1	Kg
4	G1/8	7883 04 10	21,5	53	21	46,5	52,0	12	0,166
	G1/8	7883 06 10	21,5	53	21	46,5	52,0	12	0,163
6	G1/4	7883 06 13	21,5	53	21	46,5	52,0	12	0,166
	G1/4	7883 08 13	27	57,5	24,5	54	60,0	14	0,252
8	G3/8	7883 08 17	27	57,5	24,5	54	60,0	14	0,254

Función combinada racor de bloqueo / regulador de caudal Temperatura de trabajo: 0 a +70°C

Válvulas anti-retorno pilotadas



Las válvulas anti-retorno pilotadas están destinadas a proteger las instalaciones: en caso de corte de la llegada de aire comprimido, bloquean la alimentación del cilindro y lo mantienen así- en su posición.

Ø métrico:
6 a 12 mm

Características técnicas

- **Fluidos adecuados:** aire comprimido
- **Presión de trabajo:** 1 a 10 bar
- **Temperatura de trabajo:** -5°C a +60°C
- **Umbral de apertura de la válvula:** 0,3 bar

Ventajas

- Montaje por parejas directamente en el cilindro
- 3 funciones en 1 producto:
 - válvula anti-retorno pilotada
 - regulador de caudal
 - purga manual
- Ahorro de tiempo al volver a arrancar durante una intervención gracias a la purga

Materiales

Sin silicona

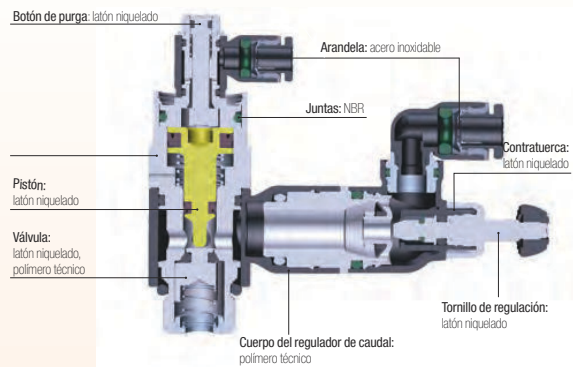

Reglamentaciones

- RoHS
- REACH
- PED

Principio de funcionamiento

Funcionamiento normal

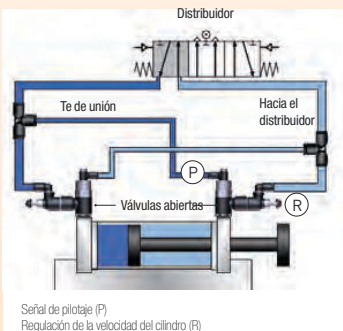

Parada de emergencia o caída de presión

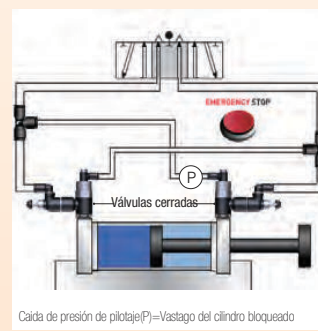

Purgador

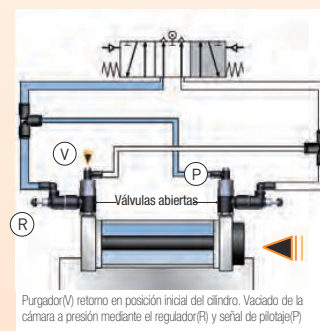

Modelo		Umbral de pilotaje y despilotaje				
		2 bar	4 bar	6 bar	8 bar	10 bar
G1/8	pilotaje	1,2	1,72	2,44	2,96	3,56
	despilotaje	0,56	0,96	1,12	1,76	2,12
G1/4	pilotaje	0,92	1,52	2,12	2,68	3,28
	despilotaje	0,64	1,16	1,68	2,16	2,64
G3/8	pilotaje	1,12	1,84	2,56	3,32	4,08
	despilotaje	0,64	1,04	1,44	1,84	2,36
G1/2	pilotaje	1,04	1,60	2,12	2,76	3,88
	despilotaje	0,76	1,28	1,76	2,20	2,72

Caudal máximo a 6 bar (NI/min)	7894 06 10	7894 06 13	7894 08 10	7894 08 13	7894 08 17	7894 10 17	7894 10 21	7894 12 21
Sentido regulación	250	475	240	585	875	940	1535	1560
Sentido retorno	365	620	355	815	1085	1205	1860	1940

Válvulas anti-retorno pilotadas

7892 Válvula anti-retorno pilotada, rosca macho BSPP

Polímero técnico, Latón niquelado, NBR



ØD	C		E	F	G	H	H1	H2	L	Kg
6	G1/8	7892 06 10	6	13	14	42	30	7	21	0,020
	G1/4	7892 06 13	9	17	18,5	45	32	9	23	0,042
8	G1/8	7892 08 10	6	13	14	42	29	9	25	0,020
	G1/4	7892 08 13	9	17	18,5	45	32	9	27	0,042
8	G3/8	7892 08 17	6	20	22,5	57	41	11	28	0,093
	G3/8	7892 10 17	6	20	22,5	57	41	11	31	0,144
10	G1/2	7892 10 21	10	24	28	63	47	16	36	0,109
	G1/2	7892 12 21	10	24	28	63	47	16	36	0,150

7894 Válvula anti-retorno pilotada regulador de caudal y purga, rosca macho BSPP

Polímero técnico, Latón niquelado

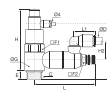

ØD	C		E	F1	F2	G	H	H1	H2	H3	L	L max	L1	Kg
6	G1/8	7894 06 10	6	13	8	14	46	7	24	31	48,5	51,0	16	0,041
	G1/4	7894 06 13	9	17	10	18,5	49	11	18	31	59,5	65,0	17	0,067
8	G1/8	7894 08 10	6	13	8	14	46	7	27	31	48,5	51,0	22	0,051
	G1/4	7894 08 13	9	17	10	18,5	49	11	23	31	59,5	65,0	23	0,068
8	G3/8	7894 08 17	7	20	14	22,5	69	13	21	40	67,5	73,0	23	0,060
	G3/8	7894 10 17	7	20	14	22,5	69	13	29	40	67,5	73,0	26	0,061
10	G1/2	7894 10 21	9	24	17	28	76	12,5	26	47	74	81,0	26	0,234
	G1/2	7894 12 21	9	24	17	28	76	12,5	27	47	74	81,0	30	0,237

Válvulas de purga rápida metálicas



La gama completa de válvulas de purga rápida metálicas se ofrece en latón niquelado, aluminio y acero inoxidable. Estas válvulas aumentan la velocidad de retorno del cilindro haciendo pasar el escape directamente a la atmósfera.

Características técnicas

- **Fluidos adecuados:** aire comprimido
- **Presión de trabajo:** 7970: 0,7 a 10 bar
7971 y 7899: 2 a 10 bar
- **Temperatura de trabajo:** 7970: -20°C a +70°C
7971: -10°C a +70°C
7899: Roscas G1/8 y G1/4: -10°C to +120°C
Roscas G3/8 a G1: -20°C a +180°C

Materiales

Sin silicona

Juntas de labio:
7970-7971: elastómero poliuretano
7899: G1/8 y G1/4, FKM
G3/8 a G1, poliuretano

Cuerpo:

Modelo 7970: latón niquelado
Modelo 7971: aluminio anodizado
Modelo 7899: acero inoxidable

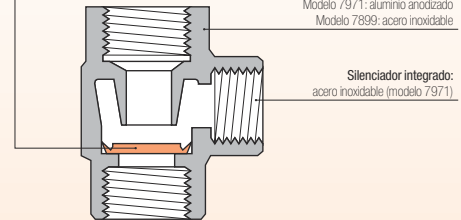

Ventajas

- Reducción de los tiempos de ciclo: velocidad de retorno elevada
- Silenciador de escape integrado y orientación de 360° está disponible en algunas versiones

Reglamentaciones

- RoHS
- REACH
- PED

Principio de funcionamiento

Montaje sobre cilindro

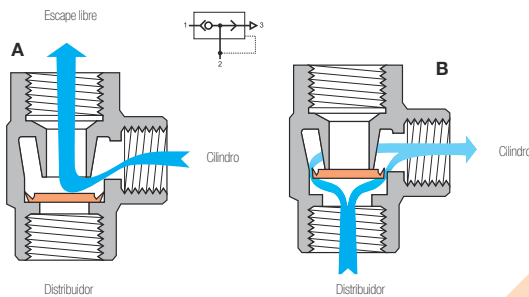

Esquema de montaje

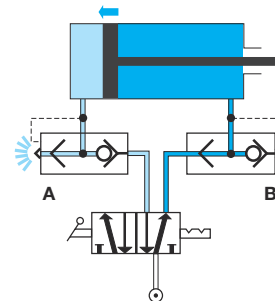

7970 Racor de purga rápida en codo, rosca hembra BSPP y métrica

Latón niquelado

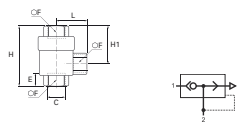

C	E	F	H	H1	L	Kg
M5x0,8 7970 19 19	5	10	24,8	15,6	4	0,029
G1/8 7970 10 10	7,5	14	42	28	8	0,084
G1/4 7970 13 13	11	19	53	34,5	11	0,150
G3/8 7970 17 17	12	21	58	36	12	0,153
G1/2 7970 21 21	14	26	71	44	14	0,312
G3/4 7970 27 27	16	32	86	52	18	0,449
G1 7970 34 34	19	38	94	56	19	0,528

7971 Racor purga rápida en línea, rosca macho BSPT / hembra BSPP

Aluminio tratado

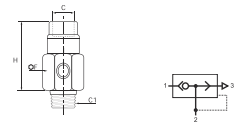

C	C1	F	H	Kg	
G1/8	R1/8	7971 10 10	18	51	0,013
G1/4	R1/4	7971 13 13	18	49	0,018
G3/8	R3/8	7971 17 17	27	56	0,048
G1/2	R1/2	7971 21 21	34	70	0,086

Nivel sonoro :
7971 10 10 : 70 dBa
7971 13 13 : 70 dBa
7971 17 17 : 72 dBa
7971 21 21 : 88 dBa

Válvulas de purga rápida metálicas

7899 Válvula de purga, rosca hembra BSPP

Acero inox 316L

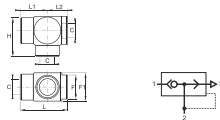

DN	C		F	F1	H	L	L1	L2	Kg
7	G1/8	7899 00 10	17	22	31,5	37,5	21	16,5	0,096
	G1/4	7899 00 13	17	22	31,5	37,5	21	16,5	0,083
9	G3/8	7899 00 17	22	26	37	44,5	25,5	19	0,140
12	G1/2	7899 00 21	27	32	45	54	31	23	0,235
18	G3/4	7899 00 27	38	46	65	79	44	35	0,800
	G1	7899 00 34	38	46	65	79	44	35	0,667

Nivel sonoro :
7971 10 10 : 70 dBa
7971 13 13 : 70 dBa
7971 17 17 : 72 dBa
7971 21 21 : 88 dBa

Válvulas anti-retorno



Las válvulas anti-retorno aseguran el paso del aire comprimido en un sentido y lo bloquean en sentido contrario. Montadas antes del circuito que se debe proteger, aseguran una perfecta protección.

Ø métrico:
4 a 12 mm

Características técnicas

Fluidos adecuados	aire comprimido	
Presión de trabajo	1 a 10 bar	
Temperatura de trabajo	0°C a +70°C	
Umbral de apertura de la válvula	0,3 bar	
Características de caudales (NI/min)	Modelo	Caudal en aire a 6 bar
	4 mm	350
	6 mm	670
	8 mm	1080
	10 mm	2230
12 mm	2300	

Materiales

Sin silicona

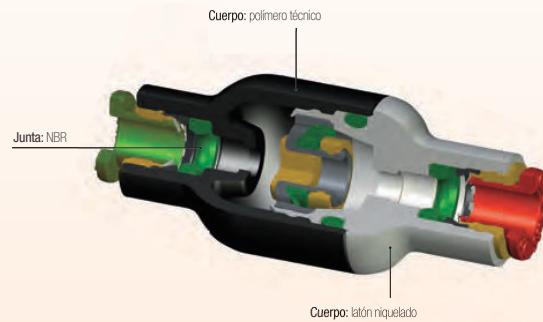

Ventajas

- Disponible en racor de entrada o unión de conexión instantánea
- Durabilidad testada según exigencias de DI 2006/42/CE

Instalación segura:

- Símbolo que indica el sentido de funcionamiento de la válvula
- Botón pulsador verde: alimentación ; botón pulsador rojo: escape

Reglamentaciones

- RoHS
- REACH
- PED
- B10d: > 40 millones de ciclos

Principio de funcionamiento

Modelo en línea

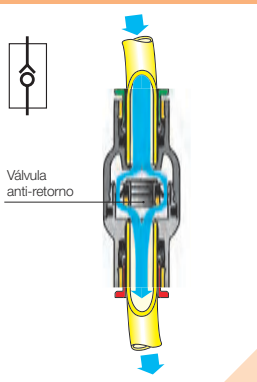

Modelo en la alimentación

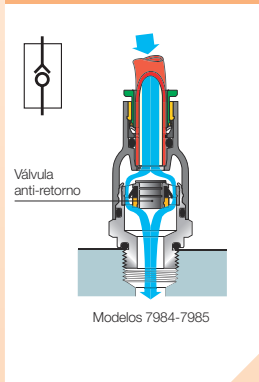

Modelo en el escape

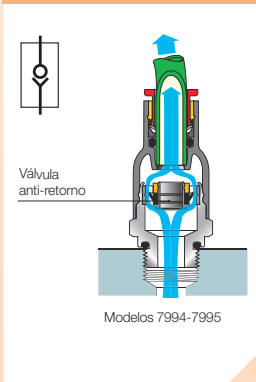

Esquema de implantación

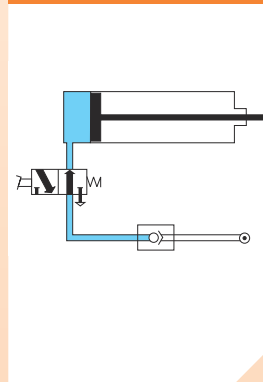

Válvulas anti-retorno

7996 Unión igual anti-retorno

Polímero técnico, Latón niquelado, NBR

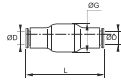

ØD		G	L	Kg
4	7996 04 00	16	38,5	0,008
6	7996 06 00	16	41	0,013
8	7996 08 00	19	51,5	0,017
10	7996 10 00	23	63,5	0,070
12	7996 12 00	23	66,5	0,050

7985 Racor recto anti-retorno alimentación, rosca BSPT

Polímero técnico, Latón niquelado, NBR

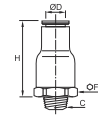

ØD	C	F	H	Kg
4	R1/8 7985 04 10	16	28,5	0,016
6	R1/8 7985 06 10	16	30,5	0,016
	R1/4 7985 06 13	16	30,5	0,021
8	R1/8 7985 08 10	19	36	0,022
	R1/4 7985 08 13	19	36	0,020
12	R1/2 7985 12 21	23	44	0,048

Rosca con "pre-coating"

7984 Racor recto anti-retorno alimentación, rosca BSPP y métrica

Polímero técnico, Latón niquelado, NBR

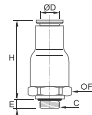

ØD	C	E	F	H	Kg
4	M5x0,8 7984 04 19	3	9	32	0,008
	G1/8 7984 04 10	5	16	28,5	0,015
6	G1/8 7984 06 10	5	16	30,5	0,015
	G1/4 7984 06 13	5,5	16	30,5	0,015
8	G1/8 7984 08 10	5	19	36	0,021
	G1/4 7984 08 13	5,5	19	36	0,023

7995 Racor recto anti-retorno escape, rosca BSPT

Polímero técnico, Latón niquelado, NBR

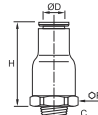

ØD	C	F	H	Kg
4	R1/8 7995 04 10	16	28,5	0,015
6	R1/8 7995 06 10	16	30,5	0,016
	R1/4 7995 06 13	16	30,5	0,022
8	R1/8 7995 08 10	19	36	0,022
	R1/4 7995 08 13	19	36	0,026
12	R3/8 7995 12 17	23	42	0,042

Rosca con "pre-coating"

7994 Racor recto anti-retorno escape, rosca BSPP y métrica

Polímero técnico, Latón niquelado, NBR

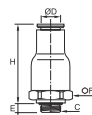

ØD	C	E	F	H	Kg
4	M5x0,8 7994 04 19	3	9	32	0,790
	G1/8 7994 04 10	5	16	28,5	0,018
6	G1/8 7994 06 10	5	16	30,5	0,015
	G1/4 7994 06 13	5,5	16	30,5	0,015
8	G1/8 7994 08 10	5	19	36	0,023
	G1/4 7994 08 13	5,5	19	36	0,023
12	G1/2 7994 12 21	7,5	23	44	0,045

Válvulas anti-retorno regulables de latón niquelado



Las válvulas anti-retorno regulables aseguran el paso del aire comprimido en un sentido y lo bloquean en sentido contrario. Este producto integra una regulación muy fina de la presión de apertura para una mayor flexibilidad.

Características técnicas

- **Fluidos adecuados:** aire comprimido
- **Presión de trabajo:** 0 a 12 bar
- **Temperatura de trabajo:** -20°C a +80°C

Fluidos adecuados	Roscas		0 a 4 vueltas (valores indicativos)			
		M5x0,8 - G1/8 - G1/4		1 a 0,10 bar		
	G3/8		1 a 0,15 bar			
	G1/2		1 a 0,20 bar			

Par de apriete máx.	Roscas					
	M5 x0,8	G1/8	G1/4	G3/8	G1/2	
daN.m	0,16	0,8	1,2	3	3,5	

Ventajas

- Regulación y bloqueo del umbral de apertura de la válvula mediante dos llaves Allen distintas que impide cualquier desajuste imprevisto
- Diseño con tuerca de bloqueo que asegura la regulación inicial en caso de vibraciones y manipulaciones involuntarias
- Adecuado para la industria agroalimentaria (cumplimiento de la FDA) y formas exteriores lisas que facilitan la limpieza in situ

Principio de funcionamiento

Etapas 1

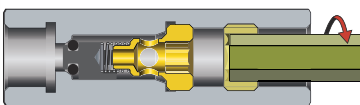

Desenroscar la tuerca de apriete con una llave Allen.

Etapas 2

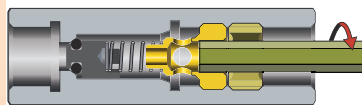

Desenroscar la tuerca de regulación con una llave Allen más pequeña para regular la presión de apertura de la válvula. El número de vueltas permite regular la presión de apertura de 1 bar a 0,10 bar.

Etapas 3

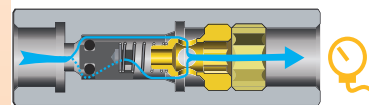

Volver a enroscar la tuerca de apriete con la llave Allen para bloquear la tuerca de regulación. Comprobar a continuación la presión con un manómetro.

Materiales

Componentes externos

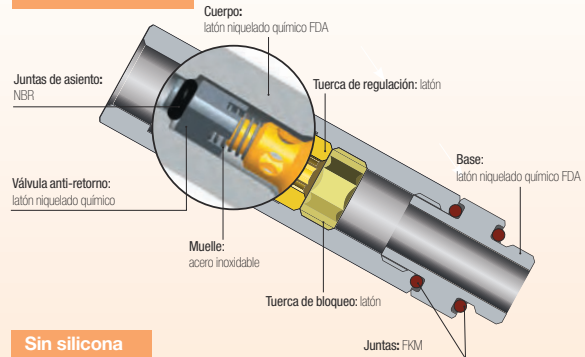

Sin silicona

Reglamentaciones

- RoHS
- REACH
- FDA : 21CFR

7930 Válvula anti-retorno ajustable doble hembra, rosca BSPP y métrica

Latón niquelado químico FDA, FKM

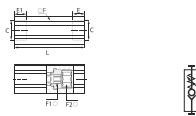

C	E	E1	F	F1	F2	L	Kg
M5x0,8 7930 19 19	8	4	13	4	6	49	0,055
G1/8 7930 10 10	8	6	13	4	6	45	0,033
G1/4 7930 13 13	10	7,5	16	6	8	54	0,073
G3/8 7930 17 17	11	8,5	20	8	10	61,5	0,163
G1/2 7930 21 21	13	10	24	10	12	73	0,171

7931 Válvula anti-retorno ajustable alimentación, rosca macho / hembra BSPP

Latón niquelado químico FDA, FKM

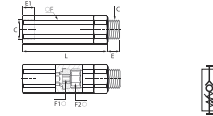

C	E	E1	F	F1	F2	L	Kg
G1/8 7931 10 10	5,5	6	13	4	6	51,5	0,043
G1/4 7931 13 13	6,5	7,5	16	6	8	61,5	0,208
G3/8 7931 17 17	7,5	8,5	20	8	10	70	0,125
G1/2 7931 21 21	9	10	24	10	12	82,5	0,212

Válvulas anti-retorno regulables de latón niquelado

7932 Válvula anti-retorno ajustable escape, rosca macho / hembra BSP

Latón niquelado químico FDA, FKM

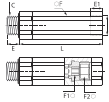

C		E	E1	F	F1	F2	L	Kg
G1/8	7932 10 10	5,5	8	13	4	6	51,5	0,009
G1/4	7932 13 13	6,5	10	16	6	8	61,5	0,058
G3/8	7932 17 17	7,5	11	20	8	10	70	0,123
G1/2	7932 21 21	9	13	24	10	12	82,5	0,212

Productos complementarios para válvulas anti-retorno regulables

Racores

LF 3000®



LF 3600



Accesorios niquelados



Válvulas anti-retorno LIQUIfit®



LIQUIfit® responde perfectamente a las exigencias de paso de los líquidos alimentarios y evita cualquier retorno de flujo. Instalada en el circuito, permite una protección total del mismo.

Ø métrico: 6 a 12 mm
Ø pulgadas: 1/4" a 1/2"

Características técnicas

- **Fluidos adecuados:** agua, bebidas, fluidos alimentarios
- **Presión de trabajo:** 1 a 10 bar
- **Temperatura de trabajo:** 1°C a +65°C
- **Umbral de apertura de la válvula:** 0,02 bar hasta O.D. 3/8" / 0,03 bar per O.D. 1/2"

Ventajas

- Perfectamente adecuada para usos con agua, bebidas y fluidos alimentarios (líquidos y gases)
- Excelente compatibilidad química
- Diseño higiénico gracias a sus superficies muy lisas

Materiales

Sin silicona



Reglamentaciones

- RoHS
- FDA: 21 CFR
- NSF 51
- REACH

7992 Válvula anti-retorno

POM, EPDM

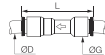

ØD		G	L	Kg
6	7992 06 00WP2	15,5	45,5	0,007
8	7992 08 00WP2	17,5	48,5	0,010
10	7992 10 00WP2	20	57,5	0,014
12	7992 12 00WP2	23,5	67,5	0,022

7992 Válvula anti-retorno

Pulgadas

POM, EPDM



ØD		G	L	Kg
1/4	7992 56 00WP2	17	51	0,008
3/8	7992 60 00WP2	20	55	0,011
1/2	7992 62 00WP2	23	68	0,021

5/16" también disponible = 7992 08 00WP2

Productos asociados

En este catálogo se incluye la gama completa de productos LIQUIfit®:

- Racores instantáneos para tubo métrico y tubo en pulgadas (capítulo 1)
- Válvulas (capítulo 4)

Como complemento de la gama LIQUIfit®, la gama de tubo PE Advanced (capítulo 3) es adecuada para los entornos más exigentes, aprobada para el contacto permanente con las bebidas y los productos alimentarios y en el tratamiento del agua.

Válvulas anti-retorno regulables de acero inoxidable



Las válvulas anti-retorno de acero inoxidable responden de manera óptima a los entornos severos y al transporte de numerosos fluidos industriales. Aseguran el paso de los fluidos en un sentido y lo bloquean en sentido contrario.

Características técnicas

- **Fluidos adecuados:** Numerosos fluidos
- **Presión de trabajo:** 0,5 a 40 bar
- **Temperatura de trabajo:** -20°C a +180°C

	Roscas	NI/min	Kv
Características de caudales en agua	G1/8	18,88	1,60
	G1/4	19,91	1,69
	G3/8	35,54	3,01
	G1/2	36,50	3,10
	G3/4	65,86	5,59
Umbral de apertura de la válvula	G1	92,60	7,86
		0,25 bar	

Ventajas

- Extremadamente robusto mecánicamente y dimensiones reducidas
- Adecuado para entornos sometidos a tensiones químicas importantes
- Seguridad gracias al símbolo que indica el sentido del fluido
- Contribución a la higiene de los equipos gracias a su superficie exterior lisa

Materiales

Sin silicona

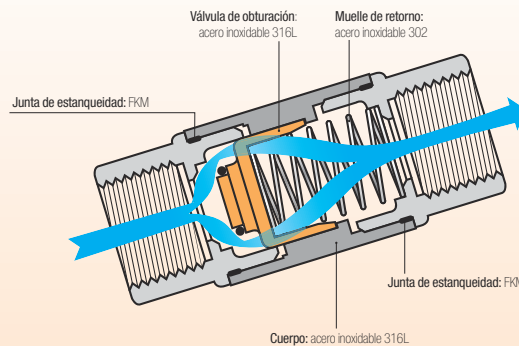

Reglamentaciones

- RoHS
- REACH
- PED

4890 Válvula anti-retorno, rosca hembra BSPP

Acero inox 316L, FKM

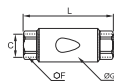

DN	C	F	G	L	Kg
10	G1/8 4890 10 10	17	22	50	0,082
	G1/4 4890 13 13	17	22	50	0,073
15	G3/8 4890 17 17	22	30	67	0,183
	G1/2 4890 21 21	24	30	71	0,182
20	G3/4 4890 27 27	32	42	84	0,288
25	G1 4890 34 34	38	42	90	0,418

4892 Válvula anti-retorno alimentación, rosca hembra BSPP / escape macho BSPP

Acero inox 316L, FKM

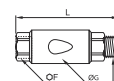

DN	C	F	G	L	Kg
10	G1/8 4892 10 10	17	22	56	0,090
	G1/4 4892 13 13	17	22	58	0,082
	G3/8 4892 17 17	22	30	75	0,191
15	G1/2 4892 21 21	24	30	79	0,210
20	G3/4 4892 27 27	32	42	84	0,313
25	G1 4892 34 34	38	42	102	0,514

4891 Válvula anti-retorno alimentación, rosca macho BSPP/escape hembra BSPP

Acero inox 316L, FKM

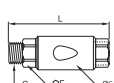

DN	C	F	G	L	Kg
10	G1/8 4891 10 10	17	22	56	0,084
	G1/4 4891 13 13	17	22	58	0,082
15	G3/8 4891 17 17	22	30	75	0,191
	G1/2 4891 21 21	24	30	79	0,210
20	G3/4 4891 27 27	32	42	84	0,300
25	G1 4891 34 34	38	42	102	0,519

4895 Válvula anti-retorno, rosca hembra NPT

Acero inox 316L, FKM

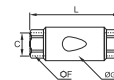

DN	C	F	G	L	Kg
10	NPT1/8 4895 11 11	17	22	50	0,082
	NPT1/4 4895 14 14	17	22	54	0,079
15	NPT3/8 4895 18 18	22	30	67	0,194
	NPT1/2 4895 22 22	24	30	77	0,195

Racores de arranque progresivo



Gracias al aumento progresivo en presión del circuito posterior, estos racores participan de este modo en la prevención de riesgos de accidentes industriales.

Ø métrico:
8 a 10 mm

Características técnicas

- **Fluidos adecuados:** aire comprimido
- **Presión de trabajo:** 3 a 10 bar
- **Temperatura de trabajo:** -15°C a +60°C

Par de apriete máx.	Roscas		daN.m
		G1/4	
	G3/8		1,5
	G1/2		1,8

Características de caudal	Modelo	Caudal a 6 bar	Kv
		7860 08 13	1500 NI/min
	7860 10 13	2100 NI/min	1,20
	7860 10 17	2200 NI/min	1,30
	7870 08 13	1500 NI/min	0,80
	7870 10 13	2000 NI/min	1,15
	7870 10 17	2000 NI/min	1,15

Materiales

Sin silicona



01 // Racores

Principio de funcionamiento

Modelo para seccionador

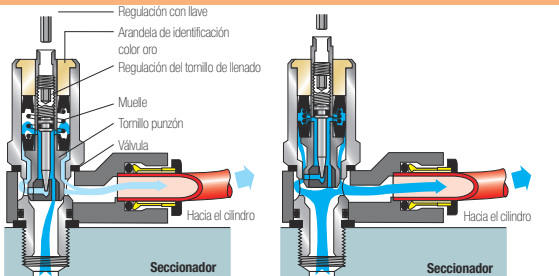

Modelo para distribuidor

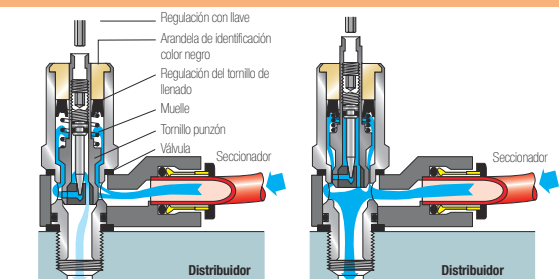

Regulación del tornillo de llenado

Actuando sobre el tornillo-punzón se regula la velocidad de paso de aire, lo cual permite optimizar la duración de llenado en función del volumen y de las características específicas de la instalación.

- Para proceder con la regulación:
- inmovilizar el pistón mediante una llave
 - regular el tornillo punzón con una llave Allen
 - llave de 1,5 para Ø 8 mm
 - llave de 2,5 para Ø 10 y 12 mm

Par apriete máx.: 0,1 daN.m

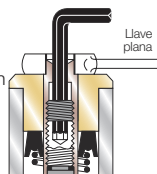

Ventajas

Protección de personas y equipos:

- Prevención de riesgos de accidente después de cualquier parada de una instalación en la que se haya realizado una purga
- Retorno a la posición memorizada de su distribuidor con total seguridad
- Regulación del tiempo de puesta a presión

Montados en seccionador:

- 7860: arandela de identificación amarilla
- Protección de toda la instalación
- Velocidad de llenado simultánea de toda la instalación posterior

Montados en distribuidor:

- 7870: arandela de identificación negra
- Selección de los circuitos que se deben proteger
- Optimización de la velocidad de llenado del cilindro montado en el circuito del distribuidor

Reglamentaciones

- RoHS
- REACH
- PED

Ciclo de presión del cilindro

Cuando la presión de salida llega a los 2/3 de la presión de alimentación, el paso total se establece automáticamente.

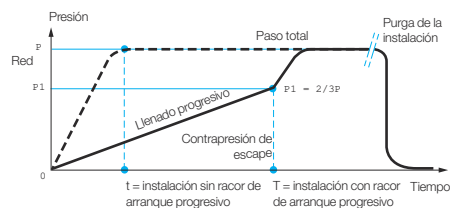

Racores con funciones

Válvulas anti-retorno de acero inoxidable

Racores de arranque progresivo

7860 Racor de arranque progresivo para seccionador, rosca macho BSPP

Polímero técnico, Latón niquelado, NBR

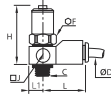

ØD	C		F	H max	H min	J	L	L1	Kg
8	G1/4	7860 08 13	17	61	54	20	35	10	0,064
	G1/4	7860 10 13	22	62	55	25	41	12,5	0,112
10	G3/8	7860 10 17	22	62	55	25	41	12,5	0,115

7870 Racor de arranque progresivo para distribuidor, rosca macho BSPP

Polímero técnico, Latón niquelado, NBR

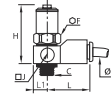

ØD	C		F	H max	H min	J	L	L1	Kg
8	G1/4	7870 08 13	17	61	54	20	35	10	0,066
	G1/4	7870 10 13	22	62	55	25	41	12,5	0,113
10	G3/8	7870 10 17	22	62	55	25	41	12,5	0,116

Nuestro programa de seguridad: Conformidad con la Directiva 2006/42/CE y la norma ISO 13849-1

Más de 250 números de parte dedicados para:

- Cero accidentes para nuestros clientes
- La integridad de la máquina
- Cumplimiento del equipo



Racores reguladores de presión



Los reguladores de presión Parker Legris estabilizan a un valor máximo determinado la presión suministrada al equipo neumático, independientemente de las variaciones en el tramo anterior.

Ø métrico:
4 a 10 mm

Características técnicas (7300)

- **Fluidos adecuados:** aire comprimido
- **Presión de trabajo:** Presión de entrada: 1 a 16 bar
Presión de salida: 1 a 8 bar
- **Temperatura de trabajo:** -10°C a +70°C

Par de apriete (BSPT)	Rosca	G1/8	G1/4	G3/8
		daN.m	0,4	0,5

Ventajas

- Regulación sencilla de la presión de salida gracias al tornillo moleteado
- Señales con cifras en el tornillo que permiten la selección de la presión requerida
- Montaje en batería en una regleta de distribución permite a partir de una presión de alimentación única, distribuir a cada equipo la presión suficiente
- Adecuado para aplicaciones que requieren controlar el esfuerzo del cilindro: cilindros de marcado, de unión, de engaste

Materiales (7300)

Sin silicona



Reglamentaciones

- RoHS
- REACH
- PED

Principio de funcionamiento

Implantación en tramo anterior al distribuidor

Regulación de la presión de alimentación en las dos cámaras del cilindro

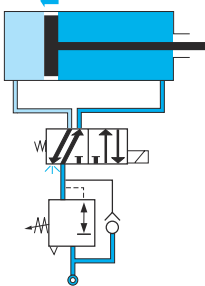

Implantación en tramo posterior al distribuidor

Fase 1: regulación de la presión de alimentación en la alimentación

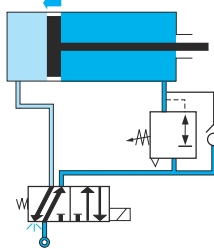

Fase 2: no altera el escape clásico por el distribuidor

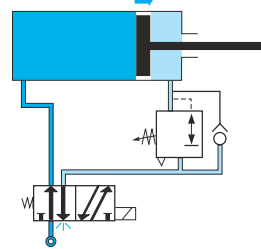

Características de caudal a 7 bar (NI/min)

modelos G1/8

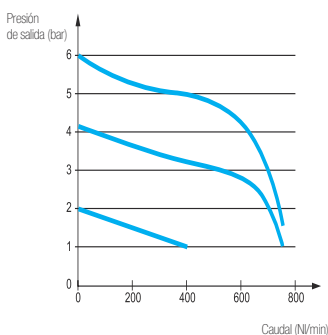

modelos G1/4

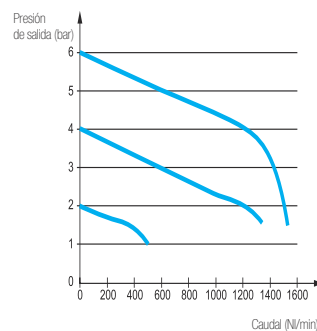

modelos G3/8

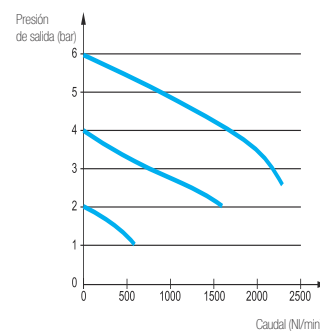

Racores reguladores de presión

7300 Regulador de presión, macho BSPP

Polímero técnico, Latón niquelado, NBR

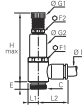

ØD	C		E	F1	F2	G1	G2	H max	L1	L2	Kg
4	G1/8	7300 04 10	4,5	17	13	14	17	65	7	18,5	0,047
	G1/8	7300 06 10	4,5	17	13	14	17	65	7	20	0,047
6	G1/4	7300 06 13	7,5	17	13	14	17	74,5	9,5	22	0,065
	G1/8	7300 08 10	4,5	17	13	14	17	65	7	25	0,048
8	G1/4	7300 08 13	7,5	17	13	14	17	74,5	9,5	27	0,066
	G3/8	7300 08 17	8,5	22	17	18,5	22	84	11,5	28,5	0,122
10	G1/4	7300 10 13	7,5	17	13	14	17	74,5	9,5	29	0,066
	G3/8	7300 10 17	8,5	22	17	18,5	22	84	11,5	30,5	0,122

DRV Reductores de presión

Latón



A	A1		HEX	L	L1	Presión de salida	Presión máxima de trabajo
G1/4	G1/4	DRV13/20	17	34	9	2 bar	15 bar
G1/4	G1/4	DRV13/30	17	34	9	3 bar	15 bar
G1/4	G1/4	DRV13/40	17	34	9	4 bar	15 bar
G1/4	G1/4	DRV13/50	17	34	9	5 bar	15 bar
G1/4	G1/4	DRV13/60	17	34	9	6 bar	15 bar
G1/4	G1/4	DRV13/70	17	34	9	7 bar	15 bar
G1/4	G1/4	DRV13/80	17	34	9	8 bar	15 bar
G1/4	G1/4	DRV13/100	17	34	9	10 bar	15 bar

Racores captadores con detección neumática

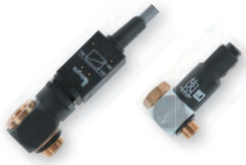

Los captadores señalan cualquier caída de presión y detectan el final de carrera de un cilindro. Emiten una señal de salida neumática o eléctrica cuando el nivel de presión en la cámara de escape del cilindro desciende por debajo de su umbral de despirotaje.

Ø métrico:
4 mm

Características técnicas

- **Fluidos adecuados:** aire comprimido
- **Presión de trabajo:** 3 a 8 bar
- **Temperatura de trabajo:** -15°C a +60°C
- **Presión de despirotaje:** 0,85 a 1 bar
- **Tiempo de conmutación:** Modelo 7818: 3 ms
- **Contacto abierto/cerrado:** Modelo 7828: 2A / 0-48 V
2A / 250 V 50 Hz

Ventajas

- Detección del final de la carrera del vástago del cilindro
- Con salida neumática**
Montaje exclusivamente neumático
2 montajes posibles:
- Alimentado en presión permanente (P1): garantiza una señal neumática cuando se alcanza la presión de despirotaje
 - Alimentado en la canalización distribuidor-cilindro del lado opuesto: no puede aparecer ninguna señal neumática (S) imprevista en la presurización gracias a la presión motriz que alimenta el racor captador (P1)

Con salida eléctrica

- Montaje combinando eléctrica y neumática
- Montaje único mediante alimentación eléctrica permanente (BU)
- Garantiza una señal eléctrica cuando se alcanza la presión de despirotaje

Materiales

Sin silicona

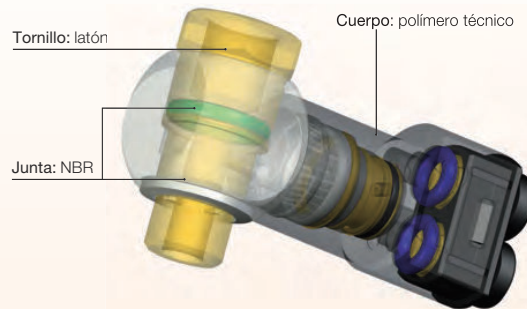

Reglamentaciones

- RoHS
- REACH
- PED

Principio de funcionamiento

Esquema montaje neumático



P': Contrapresión de escape
P: Presión motriz
P1: Presión de alimentación del captador
S: Señal de salida

Electrical Installation Diagram



La conexión se realiza mediante 3 cables de 0,5 mm² y de una longitud de 2 m.
Contactor: 5A / 250 V 5W / 48V

Cilindro en movimiento

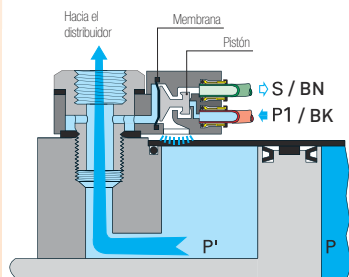

Cilindro en posición final

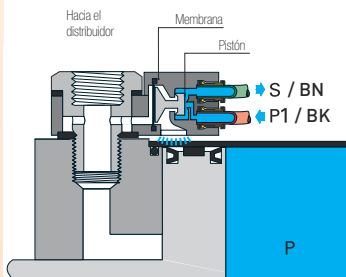

Ciclo de presión del cilindro

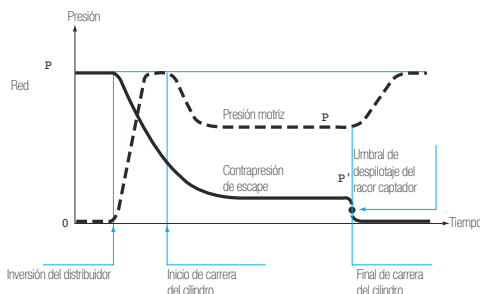

Esquema de implantación

Según el modelo, S1, S2 y P1 pueden ser neumáticas o eléctricas. Ver los esquemas de montaje al lado.

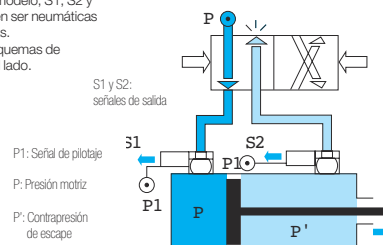

Racores captadores de detección neumática

7818 Captador neumático, rosca macho BSPP y métrica

Polímero técnico, zamak, NBR, Latón

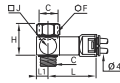

ØD	C	F	H	J	L	L1	Kg
M5x0,8	7818 04 19*	8	16	11	43,5	5,5	0,025
G1/8	7818 04 10	14	23	16	44,5	8	0,043
4	G1/4 7818 04 13	17	28	19,5	46,5	10	0,061
	G3/8 7818 04 17	22	29	23,5	49	12	0,083
	G1/2 7818 04 21	27	30	31,5	52,5	16	0,125

* Tornillo de acero cincado y bicromatado

7828 Captador eléctrico/ neumático, rosca macho/ hembra BSPP y métrica

Polímero técnico, NBR, Latón

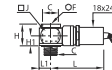

C	F	H	H1	J	L	L1	Kg
M5x0,8 7828 00 19	8	20	10	11	49	5,5	0,116
G1/8 7828 00 10	6	20	10	16	52	8	0,132
G1/4 7828 00 13	8	20	10	21	54	10,5	0,142
G3/8 7828 00 17	10	22	12	28	57	14	0,171

7818 Captador neumático, rosca macho/ hembra BSPP

Polímero técnico, zamak, NBR, Latón

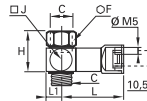

C	F	H	J	L	L1	Kg
G1/8 7818 19 10	14	23	16	40,5	8	0,049
G1/4 7818 19 13	17	28	19,5	42,5	10	0,065

Racores de intervención



Los racores de intervención permiten aislar un circuito sin purgar el conjunto de la instalación. Están diseñados para facilitar las conexiones y desconexiones repetidas, con total seguridad.

Ø métrico:
6 a 10 mm

Características técnicas

- **Fluidos adecuados:** aire comprimido
- **Presión de trabajo:** 0 a 10 bar
- **Temperatura de trabajo:** -20°C a +80°C
- **Características de caudal en aire a 6 bar:** DN 5 mm: 1000 NI/min
DN 7 mm: 1900 NI/min

Par de apriete máximos	Roscas	G1/8	G1/4	G3/8
	daN.m	0,8	1,2	3

Ventajas

- Purga parcial de la instalación durante las intervenciones y ahorro de energía y de tiempo para el mantenimiento
- Protección de las personas mediante el mantenimiento de la presión si es necesario
- Clic audible que indica la conexión correcta
- Identificación de los circuitos mediante anillo de colores (bajo demanda)

Principio de funcionamiento

Circuito cerrado

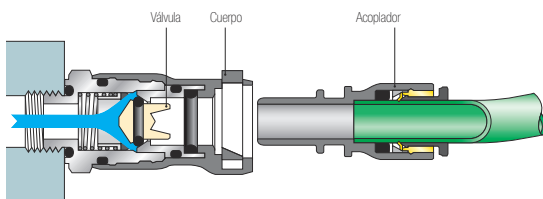

Circuito abierto

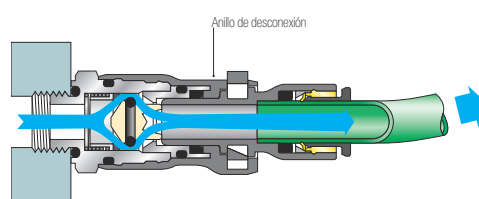

Características de caudal - Pérdidas de carga

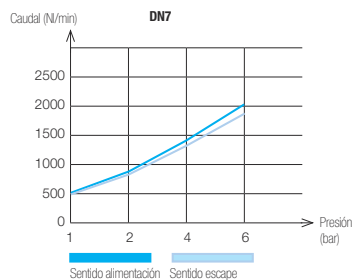
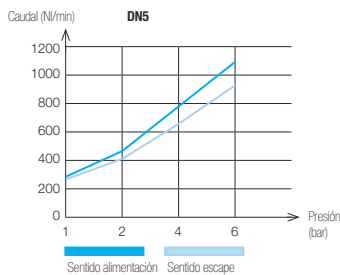

Materiales

Sin silicona

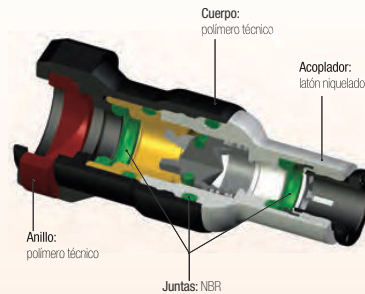

Reglamentaciones

- RoHS
- REACH
- PED

Racores de intervención

7926 Cuerpo con salida de conexión instantánea

Polímero técnico, Latón niquelado, NBR

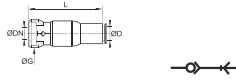

DN	ØD		G	L	Kg
5	6	7926 05 06	18,5	44	0,020
5	8	7926 05 08	18,5	49	0,024
7,3	10	7926 07 10	22	58,5	0,044

7960 Acoplador recto

Polímero técnico, NBR

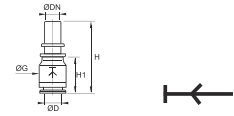

DN	ØD		G	H	H1	Kg
5	6	7960 05 06	13,5	36,5	17,5	0,007
5	8	7960 05 08	13,5	37	18	0,003
7,3	10	7960 07 10	16	41	20,5	0,004

7921 Cuerpo con rosca macho BSPP

Polímero técnico, Latón niquelado, NBR

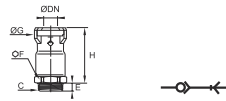

DN	C		E	F	G	H	Kg
5	G1/8	7921 05 10	5,5	16	18,5	31,5	0,021
5	G1/4	7921 05 13	5,5	16	18,5	31,5	0,023
7,3	G1/4	7921 07 13	5,5	20	22	37,5	0,039
7,3	G3/8	7921 07 17	5,5	20	22	37,5	0,040

7961 Acoplador recto, rosca macho BSPP

Polímero técnico, Latón niquelado, NBR

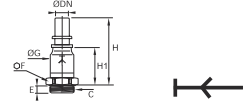

DN	C		E	F	G	H	H1	Kg
5	G1/8	7961 05 10	5,5	13	13,5	46	27	0,017
5	G1/4	7961 05 13	5,5	16	13,5	46	27	0,020
7,3	G1/4	7961 07 13	5,5	16	16	51,5	31	0,025
7,3	G3/8	7961 07 17	5,5	20	16	51,5	31	0,034

Válvulas de mando manual



Los racores de mando manual ofrecen un sistema fiable y duradero de apertura y de cierre del circuito cuando el sistema se debe cambiar frecuentemente. Permiten reducir significativamente el tiempo de intervención en los circuitos neumáticos.

Ø métrico:
4 a 8 mm

Características técnicas

- **Fluidos adecuados:** aire comprimido
- **Presión de trabajo:** 0 a 10 bar
Model 0669: 0 a 16 bar
- **Temperatura de trabajo:** -10°C a +80°C
Modelo 0669: -5°C a +70°C

Ventajas

Racores de palanca basculante:

- 2 modelos:
 - 3/2: apertura, cierre, purga
 - 2/2: apertura, cierre

Racores de corredera:

- Utilización unidireccional que garantiza la purga del circuito posterior
- Identificación inmediata del sistema de purga por el color (rojo)

Materiales

Sin silicona

Juntas: NBR

Tornillo:

Válvula de palanca basculante: latón niquelado con junta de estanqueidad
Válvula de corredera: latón niquelado

Cuerpo:

Válvula de palanca basculante: polímero técnico
Válvula de corredera: latón niquelado



Reglamentaciones

• RoHS

• REACH

• PED

Principio de funcionamiento

Racores de palanca basculante



Abierto

Cerrado

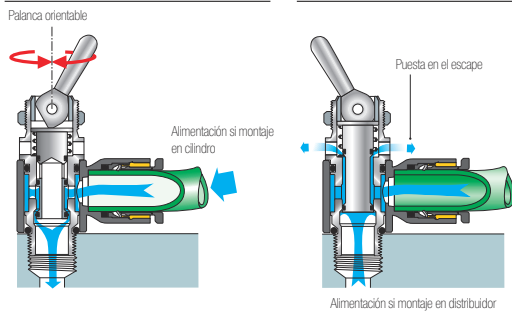

Válvulas de corredera

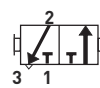

Abierto: alimentación del conducto posterior

Cerrado: puesta en el escape del conducto posterior

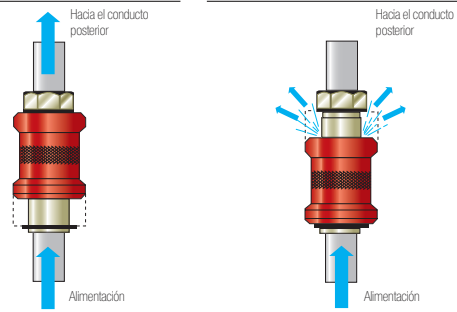

Válvulas de mando manual

7800 Válvula 3/2 de palanca basculante alimentación, rosca macho BSPP y métrica

Polímero técnico, Latón niquelado, NBR

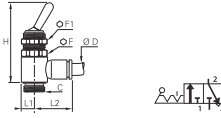

ØD	C		F	F1	H	L1	L2	Kg
4	M5x0,8	7800 04 19	14	14	55	7	18,5	0,032
	G1/8	7800 04 10	14	14	43	7	18,5	0,023
6	M5x0,8	7800 06 19	14	14	55	7	18,5	0,032
	G1/8	7800 06 10	14	14	43	7	20	0,023
8	G1/4	7800 06 13	17	14	50,5	9	22	0,048
	G1/8	7800 08 10	14	14	43	7	25	0,024
	G1/4	7800 08 13	17	14	50,5	9	27	0,049

Para las referencias 7800 04 19 y 7800 06 19, el sellado sub-base se realiza con una junta PTFE y el par de apriete del montaje es de 0,16 daN.m máximo.

7802 Válvula 2/2 con palanca basculante, rosca macho BSPP

Polímero técnico, Latón niquelado, NBR

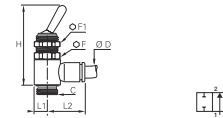

ØD	C		F	F1	H	L1	L2	Kg
4	G1/8	7802 04 10	14	14	43	7	18,5	0,023
	G1/8	7802 06 10	14	14	43	7	20	0,024
6	G1/4	7802 06 13	17	14	50,5	9	22	0,051
8	G1/8	7802 08 10	14	14	43	7	25	0,025
	G1/4	7802 08 13	17	14	50,5	9	27	0,052

7801 Válvula 3/2 de palanca basculante escape, rosca macho BSPP

Polímero técnico, Latón niquelado, NBR

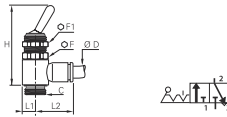

ØD	C		F	F1	H	L1	L2	Kg
4	G1/8	7801 04 10	14	14	43	7	18,5	0,023
	G1/8	7801 06 10	14	14	43	7	20	0,023
6	G1/4	7801 06 13	17	14	50,5	9	22	0,050
8	G1/8	7801 08 10	14	14	43	7	25	0,026

0669 Válvula 3/2 de corredera, rosca hembra BSPP y métrica

Latón niquelado, NBR

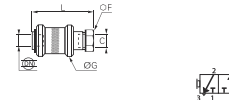

DN	C		F	G	L	Kg
2,5	M5x0,8	0669 02 19	10	14	30,5	0,012
4	G1/8	0669 04 10	14	25	48	0,050
7	G1/4	0669 07 13	19	30	58	0,096
10	G3/8	0669 10 17	22	35	68	0,154
14	G1/2	0669 14 21	27	40	75	0,210
19	G3/4	0669 19 27	32	50	83	0,330

Silenciadores



Los silenciadores, diseñados para instalarse en los circuitos en el escape, permiten reducir el nivel sonoro de los equipos en funcionamiento, mejorando así el confort de los usuarios.

Características técnicas

- **Fluidos adecuados:** aire comprimido
- **Presión de trabajo:** Polietileno: 0 a 10 bar
Bronce sinterizado: 0 a 12 bar
Acero inoxidable 316L: 0 a 12 bar
- **Temperatura de trabajo:** Polietileno: -10°C a +80°C
Bronce sinterizado: -20°C a +150°C
Acero inoxidable 316L: -20°C a +180°C

Ventajas

- 3 materiales disponibles :
 - Polietileno: excelente compromiso entre caudal de escape y atenuación del ruido
 - Bronce sinterizado: robusto y económico
 - Acero inoxidable 316L: resistencia química y mecánica aumentada
- Reguladores de caudal integrados en 2 versiones

Materiales

Sin silicona

Cuerpo:
latón (0670-0673-0675-0671-0677-0672)
polímero (0674-0676)
acero inoxidable (0682-0683)

Silenciadores:
bronce sinterizado (0670-0673-0675-0671-0677-0672)
polímero (0674-0676)
acero inoxidable 316L (0682-0683)

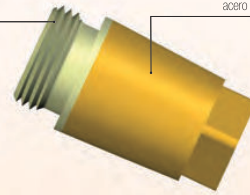

Reglamentaciones

- RoHS
- REACH
- PED
- 2003/10/CE
- OSHA

Caudales y niveles sonoros de los silenciadores 0672 y 0676

0672

	Número de vueltas						Nivel sonoro en dBA a 6 bar a 350N/min
	0	1	2	3	4	5	
0672 00 10	0	200	600	740	-	-	81
0672 00 13	0	300	650	1280	-	-	82
0672 00 17	0	450	950	1300	1500	-	83
0672 00 21	0	830	1430	1800	2100	2220	83

0676

	Número de vueltas										Nivel sonoro en dBA a 6 bar a 350N/min
	0	1	2	3	4	5	6	7	8	9	
0676 00 10	0	30	90	210	335	370	390	390	395	395	82
0676 00 13	0	22	25	50	340	750	940	980	1000	1025	84
0676 00 19	0	22	69	97	125	143	-	-	-	-	81
0676 00 17	0	518	1147	1716	2153	2571	2823	2930	-	-	85
0676 00 21		814	1849	2880	4087	5044	5236	-	-	-	86

0674 Silenciador polímero, rosca macho BSPP y métrica

Polímero técnico

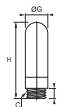

C	E	G	H	Kg
M5x0,8 0674 00 19	4	6,5	23	0,003
G1/8 0674 00 10	6	12,5	34	0,002
G1/4 0674 00 13	7	15,5	42,5	0,003
G3/8 0674 00 17	11,5	18,5	67,5	0,006
G1/2 0674 00 21	11	23,5	78	0,010
G3/4 0674 00 27	15,5	38,5	131	0,035
G1 0674 00 34	19,5	49	160	0,056

0676 Silenciador polímero regulador, rosca macho BSPP y métrica

Polímero técnico



C	F	F1	G	H	H1	Kg
M5x0,8 0676 00 19	8	1,5	9,2	16	11	0,008
G1/8 0676 00 10	13	2,5	15	20,5	14,5	0,003
G1/4 0676 00 13	15	4	18	29	22	0,006
G3/8 0676 00 17	20	6	24	38	30	0,018
G1/2 0676 00 21	25	8	30	50	40	0,045

Silenciadores

0670 Silenciador, rosca macho BSPP

Bronce sinterizado, Latón

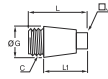

C	G	J	L	L1	Kg
G1/8 0670 00 10	12	7	22	17	0,007
G1/4 0670 00 13	15	9	27	21	0,015
G3/8 0670 00 17	19	11	35	28	0,027
G1/2 0670 00 21	23	13	43	34	0,042
G3/4 0670 00 27	30	17	55	53,5	0,089
G1 0670 00 34	37	21	65	53	0,145

0673 Silenciador compacto, rosca macho BSPP y métrica

Latón



C	E	F	H	Kg
M5x0,8 0673 00 19	4	8	8,5	0,001
G1/8 0673 00 10	6	13	12	0,008
G1/4 0673 00 13	8	16	16	0,012
G3/8 0673 00 17	8	19	17	0,022
G1/2 0673 00 21	9	24	18	0,041

0675 Silenciador con base, rosca macho BSPP y métrica

Latón



C	F	L	L1	Kg
M5x0,8 0675 00 19	8	17	13	0,002
M7x1 0675 00 55	10	23	20	0,006
G1/8 0675 00 10	13	26	20	0,014
G1/4 0675 00 13	16	34	26	0,014
G3/8 0675 00 17	19	41	33	0,024
G1/2 0675 00 21	24	46	36	0,073

0671 Silenciador enclavable

Latón niquelado



ØD	G	L	L1	Kg
4 0671 04 00	13	43,5	28,5	0,014
6 0671 06 00	15	50	33,5	0,024
8 0671 08 00	15	51	34	0,025
10 0671 10 00	19,5	67	45,5	0,052
12 0671 12 00	20	68	45	0,052

0677 Silenciador miniatura, rosca macho BSPP

Latón

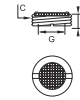

C	G	H	Kg
G1/8 0677 00 10	5,5	4	0,002
G1/4 0677 00 13	6	4,5	0,003
G3/8 0677 00 17	9,5	5	0,006
G1/2 0677 00 21	12,5	5,5	0,010
G3/4 0677 00 27	19	6	0,019
G1 0677 00 34	24	7	0,025

0672 Silenciador regulable, rosca macho BSPP

Bronce sinterizado, Latón



C	E	F	G	H max	H min	Kg
G1/8 0672 00 10	8	14	14	21	17	0,017
G1/4 0672 00 13	8	17	17	24	20	0,029
G3/8 0672 00 17	10	22	22	28	20	0,056
G1/2 0672 00 21	12	27	27	37	28	0,094

0682 Silenciador compacto, rosca macho BSPP

Acero inox 316L

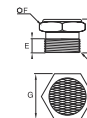

C	E	F	G	H	Kg
G1/8 0682 00 10	8	7	14	15	0,007
G1/4 0682 00 13	8	7	17	15	0,011
G3/8 0682 00 17	10	8	22	18	0,019
G1/2 0682 00 21	12	10	27	22	0,037
G3/4 0682 00 27	15	12	32	27	0,063
G1 0682 00 34	18	14	38	32	0,116

0683 Silenciador compacto, rosca macho NPT

Acero inox 316L

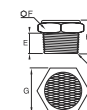



C	E	F	G	H	Kg
NPT1/8 0683 00 11	7	7	14	14	0,008
NPT1/4 0683 00 14	11	7	17	18	0,014
NPT3/8 0683 00 18	11	8	22	19	0,021
NPT1/2 0683 00 22	15	10	27	25	0,042



RACORES DE COMPRESIÓN

Racores de compresión

	Materiales	Fluidos	Presión máxima (bar)	Temperaturas		Resistencia en entornos agresivos		Page
				Min.	Max.	Mecánica	Química	
Racores de compresión								
Racores de compresión de latón 	Latón	aire comprimido, fluidos industriales	550 (dependiendo del tipo de tubo utilizado)	-60°C	+250°C	Excelente	Moderada	137
Racores de compresión de acero inoxidable 	Acero inoxidable 316L	Todos fluidos	400 (80 bar en ambientes agresivos)	-60°C	+250°C	Excelente	Excelente	151
Racores de cánula PL de latón niquelado 	Latón niquelado	aire comprimido, fluidos industriales	40 (dependiendo del tipo de tubo utilizado)	-40°C	+100°C	Buena	Buena	157

Codificación estándar de los racores de compresión

0105	14	27	99
Tipo de artículo	Ø	Rosca	Sufijo
01XX: latón 18XX: acero inoxidable	04 = 4 mm 06 = 6 mm ... 20 = 20 mm 28 = 28 mm	10 = 1/8 13 = 1/4 ... 21 = 1/2 27 = 3/4	39: junta bimaterial 40: acero tratado 60: tuerca alargada 70: material polímero 99: níquel químico

Codificación estándar de los racores PL

F3BPL	8/10	-1/4
Tipo de artículo	Ø	Rosca
FBPL F3BPL HBPL WBPL ...	2.7/4 4/6 6/8 7.5/10 8/10 10/12 11/14	BSPT: 1/8 1/4 3/8 ... Métrica: M10 M12 NPT: con adaptador BSPT y NPT

Racores de compresión de latón



Estos racores ofrecen a los usuarios un gran número de posibilidades de conexión con una gran variedad de tubos, sin soldadura ni preparación. Es la garantía de una excelente estanqueidad a lo largo del tiempo con prestaciones máximas.

Ø métrico:
4 a 28 mm

Características técnicas

- **Fluidos adecuados:** Agua, aceite de mecanizado, combustible, aceite hidráulico, aire comprimido, fluidos químicos, desinfectantes
- **Presión de trabajo:** De vacío hasta 550 bar
- **Temperatura de trabajo:** -60°C a +250°C sin junta imperdible, con tubos metálicos

Temperatura de utilización: -20°C a +100°C, con junta imperdible y tubo poliamida. Las prestaciones dependen de los fluidos, del material y del tubo utilizados. El uso está garantizado para un vacío de 755 mm Hg (99% de vacío). El sellado de la rosca está bajo responsabilidad de los usuarios.

Ventajas

- 22 configuraciones
- Excelente estanqueidad gracias al engaste del racor en el tubo
- Junta metálica para una vida útil, presión y temperatura óptimas
- Conexión de distintos tipos de tubos: metálicos, polímero, acero, caucho..
- Conexión de varios diámetros de tubos gracias al sistema de reducción de montaje

Materiales

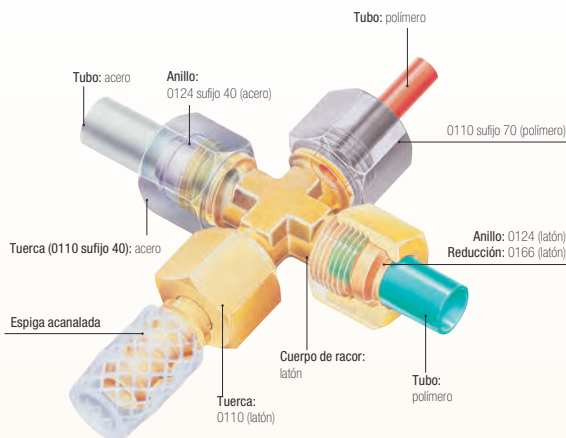

Reglamentaciones

- PED
- REACH
- RoHS

Combinaciones: Ø tubos / paso del fluido

La tabla siguiente indica los diámetros de paso máximos en función de las roscas de implantación en algunos ejemplos de diámetros de tubos.

Ø ext. del tubo	Rosca BSPP	Paso máx.
4-5-6	G1/8	4
6-8-10	G1/4	7
10-12-14	G3/8	11
14-15-16-18	G1/2	14
18-20-22	G3/4	18
22-25-28	G1	24

Longitudes de tubos para montaje

Longitud de tubo (L) mínimo a dejar entre 2 racores.

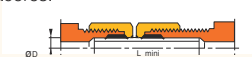

ØD	L (mm)	ØD	L (mm)	ØD	L (mm)
4	26,5	12	39	20	51
5	26	14	41	22	54
6	26	15	41	25	62
8	32	16	46,5	28	62
10	39	18	49,5		

Especificaciones técnicas del par de apriete de las tuercas

Par de apriete en daN.m =

par de apriete máximo de una tuerca 0110 y de un anillo 0124, sobre tubo de cobre o latón y sobre tubo de acero

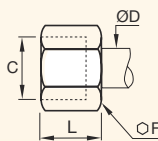

Tuerca 0110 y 0110..40

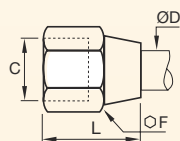

Tuerca 0110..60

Ø D (mm)	Ø F 0110	Ø F 0110..60	daN.m máx. cobre o latón	Ø F 0110..40	daN.m máx. acero
4	10	11	0,7	10	1,5
5	12	13	0,7	12	1,5
6	13	13	1,5	13	2,5
8	14	16	1,5	14	2,5
10	19	20	1,8	19	3
12	22	22	3	22	4,5
14	24	24	3,5	24	5,5
15	24	24	4	24	6
16	27	27	5	27	7
18	30	30	6	30	9
20	32	32	6	32	10
22	36	36	7	36	12
25	41	41	8	41	13
28	42		9		

Racores de compresión de latón

Instalación de los racores de compresión

Corte del tubo



Cortar el tubo de polímero o de metal en forma de codo con una herramienta adecuada.

Preparación de la conexión



Desbarbar sus bordes interiores y exteriores (tubo de metal); cuando resulte necesario el curvado del tubo, realizarlo antes de la conexión.

Deslizar la tuerca por el tubo; lubricar la rosca del cuerpo, el anillo y la rosca interior de la tuerca para facilitar el apriete (ídem para la versión de acero inoxidable); montar el anillo en el extremo del tubo.

Conexión del tubo



Poner el tubo haciendo tope contra el reborde del cuerpo del racor y pre-enrosacar a mano.

Montaje final



Enrosacar la tuerca con la llave, para obtener el engaste del anillo en el tubo; la conexión está realizada cuando se alcanza el par de apriete aconsejado (ver tablas siguientes).

En caso de arrastre del tubo (diámetro > 14 mm), se recomienda utilizar un refuerzo.

Tipo de tubo recomendado

Tubo de cobre: cobre estirado en frío y en barras rectas.

Tubo de latón: en barras rectas templadas en frío (presión de trabajo idéntico al tubo de cobre)

Tubo de "cobre recocido en rollo": reducir la presión de trabajo en un 35 % y evitar totalmente en caso de vibraciones.

Tubo de acero de circuito: tubo "fino" estirado en frío, sin soldadura, recocido blanco y en barras rectas. Uso exclusivo en tubos de acero de Ø 6 a 16 mm exterior: espesor máx. 1 mm
En diámetros superiores a 16 mm en el exterior, el espesor máximo debe ser de 1,5 mm.

Tubo de poliamida: semi-rígido
En calidad de poliamida rígida, multiplicar todas las cifras de esta tabla por 1,8.

Tipo de configuraciones recomendadas para el montaje tubo-racores

Montaje realizado con anillo Parker Legris de latón y tuerca de latón.

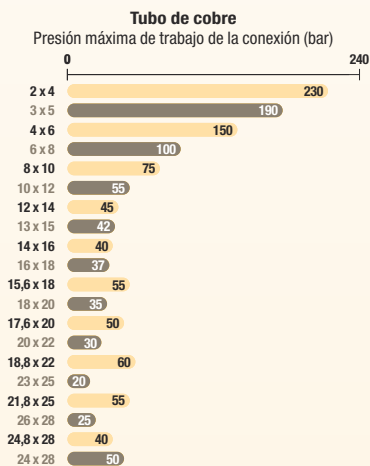

Montaje realizado con anillo Parker Legris de acero tratado y tuerca de acero tratado (serie con sufijo 40).

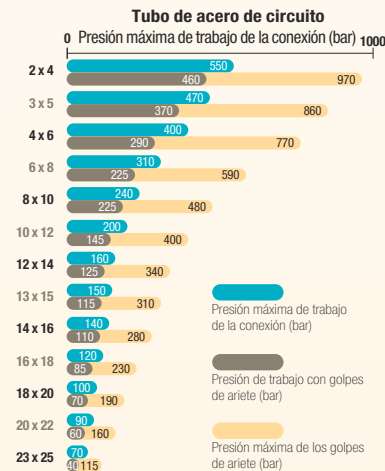

Montaje realizado con anillo y tuerca Parker Legris de latón.

Tubo de poliamida semi-rígido Parker Legris
Presión máxima de trabajo de la conexión (bar)

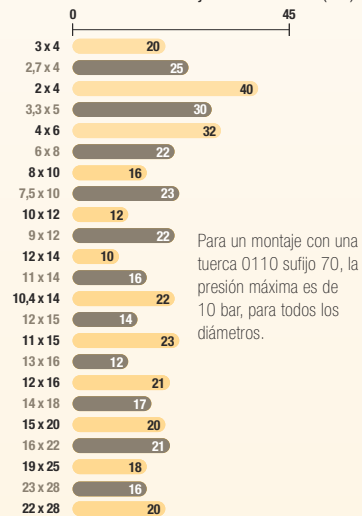

Coefficientes reductores de la presión de trabajo según la temperatura para tubos semi-rígidos

Temperatura °C	-40°C / -15°C	-15°C / +30°C	+30°C / +50°C	+50°C / +70°C	+70°C / +100°C
Factor	1,8	1	0,68	0,55	0,31

Los racores de compresión de latón Parker Legris no son compatibles con el amoníaco y sus derivados.

Las indicaciones anteriores resultan de nuestra amplia experiencia; al ser cada uso un caso particular, no pueden comprometer nuestra responsabilidad y recomendamos a nuestros clientes realizar pruebas en las condiciones reales de uso.

Racores de compresión de latón

0105 Racor de entrada recto, rosca macho BSPT

Latón

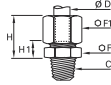

ØD	C		F	F1	H max	H1	Kg
4	R1/8	0105 04 10	10	10	17	7	0,012
R1/8	0105 05 10	11	12	17,5	7,5	0,016	
5	R1/4	0105 05 13	14	12	17,5	7,5	0,023
R1/8	0105 06 10	11	13	18	7,5	0,017	
6	R1/4	0105 06 13	14	13	18	7,5	0,024
R3/8	0105 06 17	17	13	18	8,5	0,030	
R1/8	0105 08 10	13	14	19,5	7	0,021	
8	R1/4	0105 08 13	14	14	19,5	7	0,026
R3/8	0105 08 17	17	14	20,5	8	0,032	
R1/8	0105 10 10	17	19	24	9	0,043	
10	R1/4	0105 10 13	17	19	24	9	0,047
R3/8	0105 10 17	17	19	24	9	0,048	
R1/2	0105 10 21	22	19	25	10	0,066	
R1/4	0105 12 13	19	22	24	9	0,059	
12	R3/8	0105 12 17	19	22	24	9	0,060
R1/2	0105 12 21	22	22	25	10	0,076	
R1/4	0105 14 13	22	24	25	8	0,067	
14	R3/8	0105 14 17	22	24	25	8	0,068
R1/2	0105 14 21	22	24	26	9	0,079	
R3/4	0105 14 27	27	24	27	10	0,106	
15	R3/8	0105 15 17	22	24	25	8	0,066
R1/2	0105 15 21	22	24	26	9	0,076	
R1/4	0105 16 13	24	27	27	9,5	0,092	
16	R3/8	0105 16 17	24	27	27	9,5	0,093
R1/2	0105 16 21	24	27	27	9,5	0,101	
R3/4	0105 16 27	27	27	28	10,5	0,123	
18	R1/2	0105 18 21	27	30	30	10,5	0,128
R3/4	0105 18 27	27	30	30	10,5	0,140	
20	R1/2	0105 20 21	30	32	32	11	0,147
R3/4	0105 20 27	30	32	32	11	0,160	
R1/2	0105 22 21	32	36	33	11	0,188	
22	R3/4	0105 22 27	32	36	33	11	0,198
R1	0105 22 34	36	36	33	11	0,229	
25	R3/4	0105 25 27	36	41	36	11	0,265
R1	0105 25 34	36	41	36	11	0,281	
R3/4	0105 28 27	41	42	36	11	0,273	
28	R1	0105 28 34	41	42	36	11	0,282

Bajo demanda, se pueden fabricar con roscas métricas cónicas o roscas NPT, como pedido especial, cuando las cantidades lo justifiquen.

0105 Racor de entrada recto, rosca macho NPT

Latón

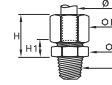

ØD	C		F	F1	H max	H1	Kg
6	NPT1/8	0105 06 11	11	13	18	7,5	0,018
NPT1/4	0105 06 14	14	13	18	7,5	0,027	
8	NPT1/8	0105 08 11	13	14	21	7	0,021
NPT1/4	0105 08 14	14	14	18,5	7	0,026	
NPT1/4	0105 10 14	17	19	24	9	0,047	
10	NPT3/8	0105 10 18	17	19	24	9	0,047
NPT1/2	0105 10 22	22	19	25	10	0,066	

0101 Racor de entrada recto con junta imperdible, rosca macho BSPP y métrica

Latón, Polímero técnico

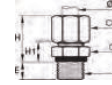

20 bar

ØD	C		E	F	F1	H max	H1	Kg
4	M5x0,8	0101 04 19	5	10	10	16,5	8	0,011
G1/8	0101 04 10	6,5	13	10	16,5	8	0,016	
5	G1/8	0101 05 10	6,5	13	12	17,5	8,5	0,019
6	G1/8	0101 06 10	6,5	13	13	18	8,5	0,020
G1/4	0101 06 13	8	17	13	18	9,5	0,030	
G1/8	0101 08 10	6,5	13	14	19	8,5	0,021	
8	G1/4	0101 08 13	8	17	14	19,5	9	0,031
G3/8	0101 08 17	11	22	14	20	10,5	0,043	
10	G1/4	0101 10 13	8	17	19	24	11	0,048
G3/8	0101 10 17	11	22	19	24	11,5	0,061	
G1/4	0101 12 13	8	19	22	24	11	0,061	
12	G3/8	0101 12 17	11	22	22	24	11,5	0,069
G1/2	0101 12 21	12	27	22	24	12	0,089	
G3/8	0101 14 17	11	22	24	25	10,5	0,075	
14	G1/2	0101 14 21	12	27	24	25	11	0,093
G3/8	0101 15 17	11	22	24	25	10,5	0,071	
15	G1/2	0101 15 21	12	27	24	25	11	0,093
G3/8	0101 16 17	11	22	27	27	12	0,092	
G1/2	0101 16 21	12	27	27	27	12,5	0,110	
18	G1/2	0101 18 21	12	27	30	29,5	12,5	0,131
G3/4	0101 18 27	13	32	30	29,5	13	0,154	
20	G3/4	0101 20 27	13	32	32	31	13	0,166
G3/4	0101 22 27	13	32	36	32	13	0,197	
22	G1	0101 22 34	15	41	36	31	13,5	0,259
28	G1	0101 28 34	15	41	42	35,5	13,5	0,300

Con junta imperdible Las juntas imperdibles referencia 0602 se encuentran en el subcapítulo "accesorios de conexión".

Racores de compresión de latón

0101..39 Racor de entrada recto con junta bi-materia, rosca macho BSPP

Latón, Acero galvanizado con junta NBR



250 bar

ØD	C		E	F	F1	H max	H1	Kg
4	G1/8	0101 04 10 39	5,5	13	10	17,5	9	0,016
	G1/8	0101 05 10 39	5,5	13	12	18,5	9,5	0,019
6	G1/8	0101 06 10 39	5,5	13	13	19	9,5	0,020
	G1/4	0101 06 13 39	7	17	13	19	10,5	0,030
8	G1/8	0101 08 10 39	5,5	13	14	20	9,5	0,022
	G1/4	0101 08 13 39	7	17	14	20,5	10	0,031
10	G3/8	0101 08 17 39	9,5	22	14	21,5	12	0,045
	G1/4	0101 10 13 39	7	17	19	25	12	0,048
12	G3/8	0101 10 17 39	9,5	22	19	25,5	13	0,062
	G1/4	0101 12 13 39	7	19	22	25	12	0,062
14	G3/8	0101 12 17 39	9,5	22	22	25	13	0,071
	G1/2	0101 12 21 39	10,5	27	22	25	13,5	0,091
15	G3/8	0101 14 17 39	9,5	22	24	26,5	12	0,074
	G1/2	0101 15 21 39	10,5	27	24	26,5	12,5	0,094
16	G3/8	0101 16 17 39	9,5	22	27	28,5	13,5	0,093
	G1/2	0101 16 21 39	10,5	27	27	28,5	14	0,111
18	G1/2	0101 18 21 39	10,5	27	30	31	14	0,131
	G3/4	0101 18 27 39	11,5	32	30	31	14,5	0,156
20	G3/4	0101 20 27 39	11,5	32	32	32,5	14,5	0,167
	G3/4	0101 22 27 39	11,5	32	36	32,5	14,5	0,200
22	G1	0101 22 34 39	13	41	36	33	15,5	0,261
28	G1	0101 28 34 39	13	41	42	37,5	15,5	0,301

Con junta bi-materia. Las juntas imperdibles referencia 0139 se encuentran en el subcapítulo "accesorios de conexión".

0101 Racor de entrada recto, rosca macho métrica

Latón

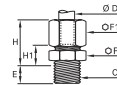

ØD	C		E	F	F1	H max	H1	Kg
4	M7x1	0101 04 55	6,5	10	10	16,5	7,5	0,012
	M8x1	0101 04 56	6,5	11	10	16,5	7,5	0,013
5	M8x1	0101 05 56	6,5	11	12	17,5	8	0,016
	M10x1	0101 05 60	6,5	14	12	17,5	8,5	0,020
6	M10x1	0101 06 60	6,5	14	13	18	8,5	0,021
	M10x1.5	0101 06 62	6,5	14	13	18	8,5	0,021
8	M12x1	0101 08 65	8	17	14	19,5	9	0,029
	M12x1.25	0101 08 66	8	17	14	19,5	9	0,029
10	M13x1.25	0101 08 68	8	17	14	19,5	9	0,030
	M14x1.25	0101 10 70	8	17	19	24	11	0,047
12	M14x1.5	0101 10 71	8	17	19	24	11	0,047
	M16x1.25	0101 10 74	9	19	19	24	11	0,052
14	M16x1.5	0101 10 75	9	19	19	24	11	0,051
	M18x1.5	0101 10 78	9	22	19	24	11,5	0,059
16	M16x1.5	0101 12 75	9	19	22	24	11	0,061
	M18x1.5	0101 12 78	9	22	22	24	11,5	0,070
18	M18x1.5	0101 14 78	9	22	24	25	10,5	0,073
	M20x1.5	0101 14 80	10	24	24	25	11	0,084
20	M20x1.5	0101 16 80	10	24	27	27	12,5	0,103
	M22x1.5	0101 16 82	10	27	27	27	12,5	0,112
22	M22x1.5	0101 18 82	10	27	30	29,5	12,5	0,131

Racores de compresión de latón

0114 Racor de entrada recto, rosca hembra BSPP

Latón

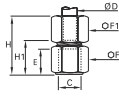

ØD	C		E	F	F1	H max	H1	Kg
4	G1/8	0114 04 10	9,5	14	10	26	16,5	0,020
	G1/4	0114 04 13	13,5	17	10	30	20,5	0,030
5	G1/8	0114 05 10	9,5	14	12	28	17	0,024
	G1/4	0114 05 13	13,5	17	12	31	21	0,032
6	G1/8	0114 06 10	9,5	14	13	28	17	0,025
	G1/4	0114 06 13	13,5	17	13	32	21	0,034
G3/8	0114 06 17	14	22	13	32	21,5	0,051	
	G1/8	0114 08 10	9,5	14	14	29	16,5	0,026
8	G1/4	0114 08 13	13,5	17	14	33	20,5	0,035
	G3/8	0114 08 17	14	22	14	34	21	0,052
10	G1/4	0114 10 13	13,5	17	19	37	21,5	0,052
	G3/8	0114 10 17	14	22	19	37	22	0,069
G1/2	0114 10 21	18,5	27	19	42	26,5	0,099	
	G1/4	0114 12 13	13,5	19	22	36	20,5	0,068
12	G3/8	0114 12 17	14	22	22	37	22	0,078
	G1/2	0114 12 21	18,5	27	22	42	26,5	0,109
14	G1/4	0114 14 13	13,5	22	24	36	18,5	0,084
	G3/8	0114 14 17	14	22	24	38	21	0,081
G1/2	0114 14 21	18,5	27	24	43	25,5	0,111	
	G3/8	0114 15 17	14	22	24	38	21	0,077
15	G1/2	0114 15 21	18,5	27	24	43	25,5	0,109
	G1/4	0114 16 13	13,5	24	27	36	18	0,109
16	G3/8	0114 16 17	14	24	27	38	20,5	0,108
	G1/2	0114 16 21	18,5	27	27	44	26	0,129
G3/8	0114 18 17	14	27	30	39	19,5	0,141	
	G1/2	0114 18 21	18,5	27	30	45	26	0,146
G3/4	0114 18 27	19,5	32	30	46	27	0,165	
	G1/2	0114 20 21	18,5	30	32	44,5	24	0,173
20	G3/4	0114 20 27	19,5	32	32	47	26,5	0,174
	G3/4	0114 22 27	19,5	32	36	48	26,5	0,204

0109 Codo, rosca macho BSPT

Latón

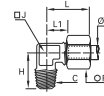

ØD	C		F	H	J	L max	L1	Kg
4	R1/8	0109 04 10	10	17	8	19,0	9,5	0,016
	R1/4	0109 04 13	10	20	10	19,0	11	0,025
5	R1/8	0109 05 10	12	17,5	8	21,0	11	0,019
	R1/4	0109 05 13	12	21,5	10	22,0	12	0,029
6	R1/8	0109 06 10	13	18	8	22,0	11	0,021
	R1/4	0109 06 13	13	21,5	10	22,0	12	0,030
R1/8	0109 08 10	14	18,5	10	28,0	15	0,028	
	R1/4	0109 08 13	14	22	10	28,0	15	0,033
R3/8	0109 08 17	14	24	12	28,0	15	0,044	
	R1/4	0109 10 13	19	25	12	30,0	14,5	0,053
10	R3/8	0109 10 17	19	25,5	12	30,0	14,5	0,059
	R1/2	0109 10 21	19	32	19	36,0	21	0,108
R1/4	0109 12 13	22	26	15	30,0	15	0,073	
	R3/8	0109 12 17	22	27	15	30,0	15	0,077
R1/2	0109 12 21	22	32	19	36,0	21	0,114	
	R3/8	0109 14 17	24	30	19	35,0	18	0,104
R1/2	0109 14 21	24	32	19	35,0	18	0,112	
	R3/8	0109 15 17	24	30	19	35,0	18	0,101
R1/2	0109 15 21	24	32	19	35,0	18	0,107	
	R3/8	0109 16 17	27	30	19	39,0	21	0,122
R1/2	0109 16 21	27	33,5	19	39,0	21	0,132	
	R3/4	0109 16 27	27	36,5	23	41,0	23	0,189
R1/2	0109 18 21	30	35,5	23	41,0	21,5	0,181	
	R3/4	0109 18 27	30	36,5	23	41,0	21,5	0,197
R1/2	0109 20 21	32	36,5	23	42,0	21,5	0,186	
	R3/4	0109 20 27	32	38	23	42,0	21,5	0,203
R3/4	0109 22 27	36	40	27	50,0	30	0,293	
	R1	0109 22 34	36	44	27	50,0	30	0,332
25	R1	0109 25 34	41	44	27	54,0	30	0,370
28	R1	0109 28 34	42	48	32	54,0	30	0,378

Bajo demanda, se pueden fabricar con roscas métricas cónicas o roscas NPT, como pedido especial, cuando las cantidades lo justifiquen.

0109 Codo, rosca macho NPT

Latón

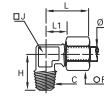

ØD	C		F	H	J	L max	L1	Kg
6	NPT1/8	0109 06 11	13	18	8	22,0	11	0,021
	NPT1/4	0109 06 14	13	21,5	10	22,0	12	0,030
8	NPT1/8	0109 08 11	14	18,5	10	28,0	15	0,027
	NPT1/4	0109 08 14	14	22	10	28,0	15	0,032
10	NPT1/4	0109 10 14	19	25	12	30,0	14,5	0,054

Racores de compresión de latón

0199 Codo orientable, rosca macho BSPP

Latón, NBR

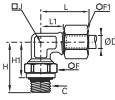

20 bar

ØD	C	F	F1	H	H1	H1 max	J	L max	L1	Kg
4	G1/8 0199 04 10	14	10	23	16	17,0	8	19,0	9,5	0,022
	G1/4 0199 04 13	19	10	30,5	22	23,5	10	19,0	11	0,043
6	G1/8 0199 06 10	14	13	23	16	17,0	8	22,0	11	0,027
	G1/4 0199 06 13	19	13	30,5	22	23,5	10	22,0	12	0,047
8	G1/8 0199 08 10	14	14	24	17	18,0	10	28,0	15	0,034
	G1/4 0199 08 13	19	14	30,5	22	23,5	10	28,0	15	0,050
10	G3/8 0199 08 17	22	14	33,5	24	25,5	12	28,0	15	0,065
	G1/4 0199 10 13	19	19	31	22,5	24,0	12	30,0	14,5	0,067
14	G3/8 0199 10 17	22	19	33,5	24	25,5	12	30,0	14,5	0,079
	G1/2 0199 10 21	27	19	40	29,5	31,0	19	37,0	22	0,136
18	G3/8 0199 14 17	22	24	35,5	26	27,5	19	35,0	18	0,115
	G1/2 0199 14 21	27	24	40	29,5	31,0	19	35,0	18	0,138
22	G1/2 0199 18 21	27	30	40	29	30,5	23	41,0	21,5	0,193
	G3/4 0199 18 27	32	30	43,5	32	33,5	23	41,0	21,5	0,224
22	G3/4 0199 22 27	32	36	45,5	34	36,0	32	51,0	31	0,381
	G1 0199 22 34	41	36	54	40,5	43,0	32	51,0	31	0,414

Racor orientable

0103 Te, rosca macho lateral BSPT

Latón

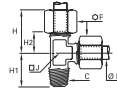

ØD	C	F	H max	H1	H2	J	Kg
4	R1/8 0103 04 10	10	19	17	9,5	8	0,025
	R1/8 0103 06 10	13	22	18	11	8	0,033
6	R1/4 0103 06 13	13	27	21,5	16	10	0,048
	R1/4 0103 08 13	14	28	22	15	10	0,050
10	R1/4 0103 10 13	19	30	25	14,5	12	0,085
	R1/4 0103 12 13	22	30	26	15	15	0,114

Bajo demanda, se pueden fabricar con roscas métricas cónicas o roscas NPT, como pedido especial, cuando las cantidades lo justifiquen.

0118..39 Banjo simple, codo orientable con tornillo, rosca macho BSPP

Latón, Acero galvanizado con junta NBR

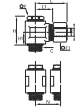

250 bar

ØD	C	F	F1	H	H1	L max	L1	N	Kg
4	G1/8 0118 04 10 39	14	10	23	9,5	24,0	14,5	17,5	0,040
	G1/8 0118 05 10 39	14	12	23	9,5	25,0	14,5	17,5	0,042
6	G1/8 0118 06 10 39	14	13	23	9,5	25,0	14,5	17,5	0,043
	G1/4 0118 06 13 39	17	13	24	10	26,0	16	21	0,058
8	G1/8 0118 08 10 39	14	14	23	9,5	28,0	15,5	17,5	0,055
	G1/4 0118 08 13 39	17	14	24	10	28,0	15,5	21	0,059
10	G3/8 0118 08 17 39	22	14	31,5	13,5	30,0	18	26,5	0,113
	G1/4 0118 10 13 39	17	19	30	13	34,0	19	23	0,118
12	G3/8 0118 10 17 39	22	19	31,5	13,5	34,0	19	26,5	0,128
	G1/4 0118 12 13 39	17	22	33	14,5	34,0	19	23	0,128
14	G3/8 0118 12 17 39	22	22	34,5	15	34,0	19	26,5	0,137
	G1/4 0118 14 13 39	17	24	36	16	37,0	20,5	28	0,190
16	G3/8 0118 14 17 39	22	24	37,5	16,5	37,0	20,5	28	0,196
	G1/2 0118 14 21 39	27	24	39	16,5	38,0	20,5	32,5	0,207
18	G1/2 0118 15 21 39	27	24	40	16,5	38,0	20,5	32,5	0,202
	G1/2 0118 16 21 39	27	27	40	16,5	38,0	21	32,5	0,225
22	G1/2 0118 18 21 39	27	30	47	20	43,0	24,5	36	0,372
	G3/4 0118 22 27 39	32	36	54	22,5	45,0	24,5	39	0,467

Con junta bi-materia. Las juntas imperdibles referencia 0139 se encuentran en el subcapítulo "accesorios de conexión".

0119 Banjo doble, te orientable, tornillo, rosca macho BSPP

Latón, Polímero técnico

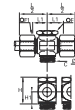

20 bar

ØD	C	F	F1	H	H1	L/2	L1	N	Kg
8	G1/4 0119 08 13	17	14	25	10	28	15,5	21	0,075
	G3/8 0119 08 17	22	14	32	13	30,5	18	26,5	0,135

Junta imperdible.
Las juntas bi-materia referencia 0139 se encuentran en el capítulo Accesorios.

Racores de compresión de latón

0119..39 Banjo doble, te orientable, tornillo, rosca macho BSPP

Latón, Acero galvanizado con junta NBR

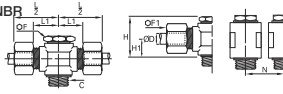

Q250 bar

ØD	C		F	F1	H	H1	L/2	L1	N	Kg
4	G1/8	0119 04 10 39	14	10	23	9,5	24	14,5	17,5	0,050
6	G1/8	0119 06 10 39	14	13	23	9,5	25	14,5	17,5	0,055
8	G1/8	0119 08 10 39	14	14	23	9,5	28	15,5	17,5	0,072
	G1/4	0119 08 13 39	17	14	24	10	28	15,5	21	0,076
10	G1/4	0119 10 13 39	17	19	30	13	34	19	23	0,156
12	G1/4	0119 12 13 39	17	22	33	14,5	34	19	23	0,180
14	G1/2	0119 14 21 39	27	24	39	16,5	38	20,5	32,5	0,256

Con junta bi-materia. Las juntas imperdibles referencia 0139 se encuentran en el subcapítulo "accesorios de conexión".

Racores especiales

Gracias a su saber hacer y a su experiencia, Parker Legris puede estudiar en estrecha colaboración con sus clientes y a partir de un pliego de condiciones, racores de compresión especiales que respondan a necesidades específicas.

La gama de racores de compresión está disponible también, por encargo, con un tratamiento de superficie níquel químico, para mejorar la resistencia a la corrosión y la compatibilidad química de los racores (a la referencia del racor se le asignará entonces un sufijo 99).

Las indicaciones anteriores resultan de nuestra amplia experiencia. Al ser cada uso un caso particular, no pueden comprometer nuestra responsabilidad y recomendamos a nuestra clientela realizar pruebas en las condiciones reales de uso.



Racores de compresión de latón / Racores de unión

0106 Unión igual

Latón



ØD		F	F1	L max	L1	Kg
4	0106 04 00	10	10	28.0	10	0,016
5	0106 05 00	11	12	31.0	11	0,023
6	0106 06 00	11	13	32.0	11	0,026
8	0106 08 00	13	14	36.0	10	0,031
10	0106 10 00	17	19	42.0	13	0,070
12	0106 12 00	19	22	42.0	13	0,091
14	0106 14 00	22	24	45.0	11	0,103
15	0106 15 00	22	24	45.0	11	0,096
16	0106 16 00	24	27	48.0	13	0,145
18	0106 18 00	27	30	53.0	14	0,190
20	0106 20 00	30	32	56.0	14	0,217
22	0106 22 00	32	36	60.0	14	0,281
28	0106 28 00	41	42	64.0	14	0,398

0102 Codo igual

Latón

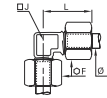

ØD		F	J	L max	Kg
4	0102 04 00	10	5	19.0	0,017
5	0102 05 00	12	8	21.0	0,025
6	0102 06 00	13	8	22.0	0,027
8	0102 08 00	14	10	28.0	0,038
10	0102 10 00	19	12	30.0	0,072
12	0102 12 00	22	15	30.0	0,097
14	0102 14 00	24	19	35.0	0,133
15	0102 15 00	24	19	35.0	0,122
16	0102 16 00	27	19	39.0	0,168
18	0102 18 00	30	23	41.0	0,236
20	0102 20 00	32	23	42.0	0,238
22	0102 22 00	36	27	50.0	0,375
28	0102 28 00	42	32	54.5	0,473

0116 Unión igual pasatabiques

Latón

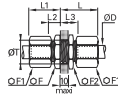

ØD		F	F1	F2	L max	L1 max	L2	L3	ØT min	Kg
4	0116 04 00	10	10	13	27.0	17.0	7	17	8,3	0,024
5	0116 05 00	13	12	14	28.0	18.0	7,5	17,5	10,3	0,035
6	0116 06 00	13	13	14	28.0	19.0	7,5	17,5	10,3	0,037
8	0116 08 00	14	14	17	29.0	20.0	7	17	12,3	0,045
10	0116 10 00	19	19	22	33.0	25.0	9	19	16,5	0,100
12	0116 12 00	22	22	22	33.0	25.0	9	19	18,5	0,121
14	0116 14 00	24	24	27	35.0	25.0	8	18	20,5	0,143
15	0116 15 00	24	24	24	35.0	25.0	8	18	20,5	0,134
16	0116 16 00	27	27	27	36.0	28.0	9,5	19,5	22,5	0,192
18	0116 18 00	27	30	30	40.0	30.0	10,5	20,5	24,5	0,238
20	0116 20 00	32	30	32	41.0	31.0	11	21	27,5	0,275
22	0116 22 00	36	36	36	42.0	32.0	11	21	30,5	0,379

0104 Te igual

Latón

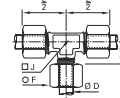

ØD		F	H	J	L/2	Kg
4	0104 04 00	10	9,5	8	19	0,029
5	0104 05 00	12	11	8	21	0,037
6	0104 06 00	13	11	8	22	0,040
8	0104 08 00	14	15	10	28	0,054
10	0104 10 00	19	14,5	12	30	0,104
12	0104 12 00	22	15	15	30	0,140
14	0104 14 00	24	18	19	35	0,190
15	0104 15 00	24	18	19	35	0,171
16	0104 16 00	27	21	19	39	0,245
18	0104 18 00	30	21,5	23	41	0,328
20	0104 20 00	32	21,5	23	42	0,336
22	0104 22 00	36	29	27	50	0,520

0142 Y igual

Latón

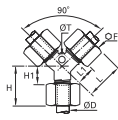

ØD		F	H max	H1	L max	L1	ØT	Kg
4	0142 04 00	10	16,5	7	26,5	17	4,2	0,031
6	0142 06 00	13	19,5	8,5	28,0	17	4,2	0,047
8	0142 08 00	14	21	8	30,0	17	6,2	0,059
10	0142 10 00	19	24,5	9	37,5	22	6,2	0,127
12	0142 12 00	22	26	11	38,0	23	6,2	0,168
14	0142 14 00	24	28	11	41,5	24,5	6,2	0,194

0107 Cruz igual

Latón

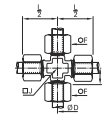

ØD		F	H	J	L/2	Kg
6	0107 06 00	13	11	8	22	0,052
8	0107 08 00	14	15	11	28	0,073
10	0107 10 00	19	14,5	14	30	0,141
12	0107 12 00	22	15	15	35	0,231
14	0107 14 00	24	18	20	35	0,244
16	0107 16 00	27	21	20	39	0,319
18	0107 18 00	30	21,5	25	41	0,436
22	0107 22 00	36	29	27	50	0,677

Complementos de los racores de compresión de latón

0166 Reducción tres piezas

Latón

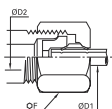

ØD1	ØD2		F	Kg
4	6	0166 04 06	13	0,011
5	6	0166 05 06	13	0,010
6	8	0166 06 08	14	0,012
6	10	0166 06 10	19	0,030
6	12	0166 06 12	22	0,043
6	14	0166 06 14	24	0,052
6	16	0166 06 16	27	0,077
8	10	0166 08 10	19	0,027
8	12	0166 08 12	22	0,040
8	14	0166 08 14	24	0,050
8	16	0166 08 16	27	0,076
10	12	0166 10 12	22	0,037
10	14	0166 10 14	24	0,045
10	16	0166 10 16	27	0,069
10	18	0166 10 18	30	0,096
10	20	0166 10 20	32	0,107
10	22	0166 10 22	36	0,146
12	16	0166 12 16	27	0,066
12	22	0166 12 22	36	0,142
14	16	0166 14 16	27	0,060
14	18	0166 14 18	30	0,084
14	25	0166 14 25	41	0,189
16	20	0166 16 20	32	0,086
16	22	0166 16 22	36	0,125
18	22	0166 18 22	36	0,118
20	25	0166 20 25	41	0,168

ØD1 = tubo a montar, ØD2 = para racor de xx mm Cada una de estas referencias incluye las 3 piezas : - la reducción propiamente dicha - el anillo latón ref 0124 - la tuerca

0124..40 Anillo de estanqueidad de acero

Acero galvanizado



ØD		Kg
4	0124 04 00 40	0,001
5	0124 05 00 40	0,001
6	0124 06 00 40	0,001
8	0124 08 00 40	0,001
10	0124 10 00 40	0,003
12	0124 12 00 40	0,004
14	0124 14 00 40	0,005
15	0124 15 00 40	0,004
16	0124 16 00 40	0,006
18	0124 18 00 40	0,007
20	0124 20 00 40	0,008
22	0124 22 00 40	0,010
25	0124 25 00 40	0,014

0111 Anillo de estanqueidad BNA*

Latón



ØD		Kg
4	0111 04 00	0,001
5	0111 05 00	0,001
6	0111 06 00	0,001
8	0111 08 00	0,001
10	0111 10 00	0,002
12	0111 12 00	0,002
14	0111 14 00	0,003
15	0111 15 00	0,003
16	0111 16 00	0,004

* BNA: Oficina de Normalización del Automóvil

0124 Anillo de estanqueidad de latón

Latón



ØD		Kg
4	0124 04 00	0,001
5	0124 05 00	0,001
6	0124 06 00	0,001
8	0124 08 00	0,001
10	0124 10 00	0,003
12	0124 12 00	0,004
14	0124 14 00	0,005
15	0124 15 00	0,004
16	0124 16 00	0,006
18	0124 18 00	0,007
20	0124 20 00	0,009
22	0124 22 00	0,012
25	0124 25 00	0,016
28	0124 28 00	0,017

0110 Tuerca de apriete de latón

Latón



ØD	C		F	L	Kg
4	M8x1	0110 04 00	10	11	0,004
5	M10x1	0110 05 00	12	11	0,006
6	M10x1	0110 06 00	13	11	0,008
8	M12x1	0110 08 00	14	13	0,008
10	M16x1.5	0110 10 00	19	15	0,019
12	M18x1.5	0110 12 00	22	15	0,025
14	M20x1.5	0110 14 00	24	15	0,029
15	M20x1.5	0110 15 00	24	15	0,028
16	M22x1.5	0110 16 00	27	17	0,044
18	M24x1.5	0110 18 00	30	18	0,059
20	M27x1.5	0110 20 00	32	18	0,059
22	M30x1.5	0110 22 00	36	19	0,081
25	M33x1.5	0110 25 00			0,131
28	M36x1.5	0110 28 00			0,108

Complementos de los racores de compresión de latón

0110..40 Tuerca de apriete de latón

Acero galvanizado



ØD	C		F	L	Kg
4	M8x1	0110 04 00 40	10	11	0,004
6	M10x1	0110 06 00 40	13	12	0,008
8	M12x1	0110 08 00 40	14	13,5	0,008
10	M16x1.5	0110 10 00 40	19	16	0,018
12	M18x1.5	0110 12 00 40	22	16,5	0,026
16	M22x1.5	0110 16 00 40	27	18	0,042
18	M24x1.5	0110 18 00 40	30	19	0,057
22	M30x1.5	0110 22 00 40	36	21,5	0,084

0110..60 Tuerca de apriete prolongado de latón

Latón



ØD	C		F	L	Kg
4	M8x1	0110 04 00 60	11	14,5	0,007
6	M10x1	0110 06 00 60	13	17,5	0,011
8	M12x1	0110 08 00 60	16	20	0,018
10	M16x1.5	0110 10 00 60	20	23	0,032
12	M18x1.5	0110 12 00 60	22	25	0,038

0110..70 Tuerca-bicorno de polímero técnico

Polímero técnico



10 bar

ØD	C		F	L	Kg
4	M8x1	0110 04 00 70	8	13	0,001
6	M10x1	0110 06 00 70	11	15	0,002

Nota : no montar esta tuerca-bicorno de plástico sobre tubos metálicos

0122 Espiga acanalada para tubo

Latón

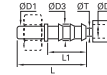

ØD1	ØD2	ØD3		L	L1	ØT min	Kg
4	4	6	0122 04 04	37,5	22,5	3	0,004
6	4	6	0122 06 04	37,5	22,5	3	0,005
	7	9	0122 06 07	37,5	22,5	6	0,007
8	6	8	0122 08 06	40	22,5	5	0,007
	7	9	0122 08 07	40	22,5	6	0,008
10	10	12,5	0122 08 10	40	22,5	9	0,012
	7	9	0122 10 07	43	22,5	6	0,010
10	10	12,5	0122 10 10	43	22,5	9	0,014
	10	12,5	0122 12 10	43	22,5	9	0,013
12	13	15	0122 12 13	50	29,5	12	0,018
	13	15	0122 14 13	52	29,5	12	0,019
14	16	18,5	0122 14 16	60,5	38	15	0,031
	13	15	0122 15 13	52	29,5	12	0,019
15	16	18,5	0122 15 16	60,5	38	15	0,032
	13	15	0122 16 13	53,5	29,5	12	0,021
16	16	18,5	0122 16 16	62	38	15	0,032
	16	18,5	0122 18 16	62	38	15	0,031
18	19	21,5	0122 18 19	62	38	18	0,040
	16	18,5	0122 20 16	64	38	15	0,034
20	19	21,5	0122 20 19	64	38	18	0,039
	22	19	21,5	0122 22 19	64	38	18
25	19	21,5	0122 25 19	70	38	18	0,048
	25	27,5	0122 25 25	70	38	24	0,054

0165 Espiga acanalada para tubo

Latón

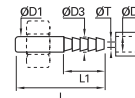

ØD1	ØD2	ØD3		L	L1	ØT min	Kg
4	4	4,3	0165 04 06	30	15	2	0,002
5	4	4,3	0165 05 06	30	15	2	0,003
	4	4,3	0165 06 06	30	15	2	0,003
6	6	6,4	0165 06 08	30	15	4	0,004
	8	8,4	0165 06 10	30	15	4	0,005
8	6	6,4	0165 08 08	32,5	15	4	0,006
	8	8,4	0165 08 10	32,5	15	6	0,006
10	10	10,7	0165 08 12	37,5	20	8	0,009
	8	8,4	0165 10 10	35,5	15	6	0,008
10	10	10,7	0165 10 12	40,5	20	8	0,010
	12	12,7	0165 10 14	40,5	20	8	0,012
12	10	10,7	0165 12 12	40,5	20	8	0,011
	12	12,7	0165 12 14	40,5	20	10	0,013
14	12	12,7	0165 14 14	42,5	20	10	0,015
15	13	13,7	0165 15 16	42,5	20	11	0,015
16	13	13,7	0165 16 16	44	20	11	0,018

Complementos de los racores de compresión de latón

0126 Tapón para racor de compresión

Latón



ØD		L	Kg
4	0126 04 00	10	0,002
6	0126 06 00	10	0,003
8	0126 08 00	11,5	0,006
10	0126 10 00	13	0,010
12	0126 12 00	13	0,014
14	0126 14 00	13,5	0,020
18	0126 18 00	16	0,038
22	0126 22 00	18	0,003

Esta pieza permite cerrar la salida de un racor. Se monta en lugar del anillo. Si posteriormente interesa utilizar esta salida, bastará cambiar el tapón por el anillo correspondiente. El tapón es reutilizable.

0125 Tapón extremo tubo para racor de compresión

Latón



ØD	C	F	L	L1	Kg	
4	M8x1	0125 04 00	10	12	8	0,005
6	M10x1	0125 06 00	11	13,5	9,5	0,008
8	M12x1	0125 08 00	14	14	9	0,013
10	M16x1,5	0125 10 00	17	18	11	0,025

Esta pieza permite tapar la salida de un tubo en el que ya se ha montado el anillo y su tuerca de apriete. Al coincidir la rosca macho del tapón con la rosca hembra de la tuerca de cierre, la salida queda totalmente cerrada. Para conectar de nuevo, bastará sacar el tapón y roscar la tuerca con su anillo, directamente al cuerpo del racor.

0220 Tapón hexagonal con junta impermeable, rosca macho BSPP y métrica

Latón, Polímero técnico

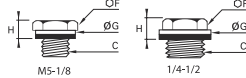

C	F	G	H1	Kg	
M5x0,8	0220 19 00	8	8	5	0,002
G1/8	0220 10 00	14	14	7,5	0,011
G1/4	0220 13 00	17	17	7,5	0,020
G3/8	0220 17 00	17	22	8,5	0,024
G1/2	0220 21 00	22	27	10	0,041

Con junta impermeable
M5: con ranura para destornillador
Máxima presión de utilización = 20 bar
Características generales según norma BNA 229 (excepto M5): rosca BSPP, norma ISO 228-1
rosca métrica ISO, norma NFE 03-054

0220..39 Tapón hexagonal con junta impermeable, rosca macho BSPP y métrica

Latón, Acero galvanizado con junta NBR

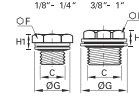

C	F	G	H	Kg	
G1/8	0220 10 00 39	14	14	6,5	0,012
G1/4	0220 13 00 39	17	17	6,5	0,020
G3/8	0220 17 00 39	17	22	8	0,025
G1/2	0220 21 00 39	22	26	9	0,042
G3/4	0220 27 00 39	22	32	10	0,059
G1	0220 34 00 39	27	39,5	10,5	0,088

Tapón con junta bi-materia.
Las juntas bi-materia referencia 0139 se encuentran en el capítulo 9.
Presión máxima 250 bar

0120 Adaptador de orientación, rosca macho BSPT

Latón



ØD	C	F	L	L1	Kg	
4	R1/8	0120 04 10	11	25,5	14	0,007
5	R1/8	0120 05 10	11	26	14,5	0,007
	R1/8	0120 06 10	11	26,5	15	0,008
6	R1/4	0120 06 13	14	31	15	0,015
	R1/8	0120 08 10	11	28,5	17	0,009
8	R1/4	0120 08 13	14	33	17	0,016
	R3/8	0120 08 17	17	33,5	17	0,020
10	R1/4	0120 10 13	14	36	20	0,017
	R3/8	0120 10 17	17	36,5	20	0,022
12	R1/2	0120 10 21	22	41	20	0,039
	R1/4	0120 12 13	14	36	20	0,017
14	R3/8	0120 12 17	17	36,5	20	0,022
	R1/2	0120 12 21	22	41	20	0,040
16	R3/8	0120 14 17	17	38	21,5	0,023
	R1/2	0120 14 21	22	42,5	21,5	0,042
15	R3/8	0120 15 17	17	38	21,5	0,023
	R1/2	0120 15 21	22	42,5	21,5	0,040
18	R3/8	0120 16 17	17	39,5	23	0,024
	R1/2	0120 16 21	22	44	23	0,042
20	R1/2	0120 18 21	22	44,5	23,5	0,042
	R3/4	0120 18 27	27	47,5	23,5	0,070
22	R3/4	0120 20 27	27	49	25	0,070
	R1	0120 22 34	36	52,5	25,5	0,117
28	R1	0120 28 34	36	57	30	0,140

Complementos de los racores de compresión de latón

0112 Tornillo para anillo de estanqueidad racor de compresión, rosca macho métrica

Latón



ØD	C		E	F	L	Kg
4	M8x1	0112 04 00	7	10	13	0,005
5	M10x1	0112 05 00	7,5	11	13,5	0,007
6	M10x1	0112 06 00	7,5	11	13,5	0,006
8	M12x1	0112 08 00	8	13	15	0,008
10	M16x1.5	0112 10 00	11	17	18	0,018
12	M18x1.5	0112 12 00	11	19	18	0,021
14	M20x1.5	0112 14 00	11	22	18	0,026

Esta pieza permite la salida de un tubo directamente de un distribuidor o de un punto de implantación por medio de un orificio especial y de un anillo universal Parker Legris. Para la mecanización de estos orificios en los que se aloja el anillo universal Parker Legris, sírvanse consultarnos.

0128..39 Adaptador de orientación con junta bi-materia, rosca macho BSPP

Latón, Acero galvanizado con junta NBR



ØD	C		E	F	H	Kg
4	G1/8	0128 04 10 39	7,5	13	20	0,009
	G1/4	0128 04 13 39	9	17	22	0,015
6	G1/8	0128 06 10 39	7,5	13	21	0,010
	G1/4	0128 06 13 39	9	17	23	0,016
8	G1/8	0128 08 10 39	7,5	13	23	0,011
	G1/4	0128 08 13 39	9	17	25	0,017
	G3/8	0128 08 17 39	12	22	26	0,033
10	G1/4	0128 10 13 39	9	17	28	0,018
	G3/8	0128 10 17 39	12	22	29	0,034
14	G1/2	0128 10 21 39	27	27	30	0,049
	G3/8	0128 14 17 39	12	22	30,5	0,035
18	G1/2	0128 14 21 39	27	27	31,5	0,049
	G1/2	0128 18 21 39	27	27	33,5	0,051
22	G3/4	0128 18 27 39	14	32	34,5	0,085
	G3/4	0128 22 27 39	14	32	36,5	0,081
28	G1	0128 22 34 39	16,5	41	38	0,123
	G1	0128 28 34 39	16,5	41	42,5	0,147

Con junta bi-materia
Las juntas bi-materia referencia 0139 se encuentran en el subcapítulo "Accesorios de conexión".

0151..39 Unión doble orientable, con junta bi-materia, rosca macho BSPP

Latón, NBR, Acero galvanizado con junta NBR



C		E	E1	F	F1	H	H1	Kg
G1/8	0151 10 10 39	5,5	7	13	14	6	6,5	0,017
G1/4	0151 13 13 39	7	8,5	17	19	6,5	9	0,036
G3/8	0151 17 17 39	9,5	9,5	22	22	9	9	0,056
G1/2	0151 21 21 39	10,5	10,5	27	27	10	10	0,082
G3/4	0151 27 27 39	11,5	11,5	32	32	11	10	0,122
G1	0151 34 34 39	13	13,5	41	41	12,5	10,5	0,217

Con junta bi-materia
Las juntas bi-materia referencia 0139 se encuentran en el subcapítulo "Accesorios de conexión".

0168..39 Reducción, rosca macho BSPP junta bi-materia / hembra BSPP y métrica

Latón, Acero galvanizado con junta NBR



C1	C2		E	F	H	Kg
G1/8	M5x0,8	0168 10 19 39	8	14	4,5	0,009
G1/4	M5x0,8	0168 13 19 39	8	17	5	0,018
G1/4	G1/8	0168 13 10 39	8	17	5	0,012
G3/8	G1/8	0168 17 10 39	10	19	5	0,020
G3/8	G1/4	0168 17 13 39	10	19	5	0,013
G1/2	G1/8	0168 21 10 39	12	24	7,5	0,053
G1/2	G1/4	0168 21 13 39	12	24	7,5	0,044
G1/2	G3/8	0168 21 17 39	12	24	7,5	0,031
G3/4	G1/4	0168 27 13 39	12	32	9,5	0,100
G3/4	G3/8	0168 27 17 39	12	32	9,5	0,086
G3/4	G1/2	0168 27 21 39	12	32	9,5	0,065

Con junta bi-materia
Las juntas bi-materia referencia 0139 se encuentran en el subcapítulo "Accesorios de conexión".

0127 Refuerzo interior de latón para tubo polímero

Latón

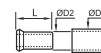

ØD1	ØD2		L	Kg
4	2	0127 04 00	11	0,001
		0127 04 25	413	0,001
4	2,7	0127 04 27	11	0,001
		0127 05 03	11	0,001
5	3,3	0127 05 00	11,5	1,000
		0127 06 00	11,5	0,001
8	5,5	0127 08 55	14	0,001
		0127 08 00	14	0,001
10	7	0127 10 07	18	0,001
		0127 10 75	18	0,001
10	8	0127 10 00	18	0,002
		0127 12 08	26	0,002
12	9	0127 12 09	18	0,001
		0127 12 00	18	0,001
14	11	0127 14 11	16	0,002
		0127 14 00	18	0,003
15	12	0127 15 12	18	0,002
		0127 16 13	18	0,003
18	14	0127 18 14	19,5	0,003
		0127 22 16	21	0,005

A temperaturas y presiones elevadas, el uso de esta piezas evita que el tubo se retraiga, garantizando un buen agarre.

Espigas acanaladas para tubo auto-retráctil



Esta gama de racores responde a las exigencias del sector del automóvil y de la robótica, combinando calidad de fabricación óptima CNOMO, larga vida útil y una sencillez de instalación para un uso seguro.

Ø métrico:
6 a 22 mm

Características técnicas

- **Fluidos adecuados:** Líquido de refrigeración, aire comprimido
- **Presión de trabajo:** 0 a 16 bar
- **Temperatura de trabajo:** 0°C a +100°C (agua)
-20°C a +70°C (aire)

Par de apriete, modelo 0132	DN	6	8	10	14	18	22
	daN.m		0,7	1,5	1,8	3,5	6

Las prestaciones dependen de los fluidos, del material y del tubo utilizados.

Ventajas

- Instalación simple y rápida
- Resistencia a las chispas
- Solución económica y de ahorro de tiempo
- Propiedades mecánicas probadas para el uso industrial robotizado

Materiales

Sin silicona

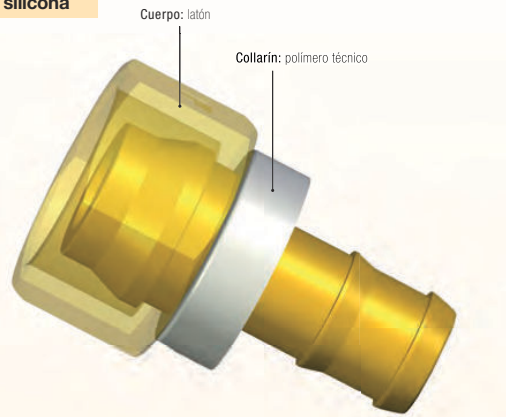

Instalación con la herramienta de ajuste

Herramienta diseñada para insertar una espiga acanalada y un tubo auto-retráctil. Referencia de la **0650 00 00 05**



Corte del tubo y colocación en la herramienta

Cortar el tubo en forma de codo y colocar la espiga en el soporte de la herramienta prevista a tal efecto.



Ajuste a presión del tubo

Accionar la herramienta de ajuste; la conexión es conforme cuando el tubo hace tope en el collarín. Esta herramienta está diseñada para adaptarse a 5 diámetros de tubos distintos y permite una manipulación sencilla, sin esfuerzo.

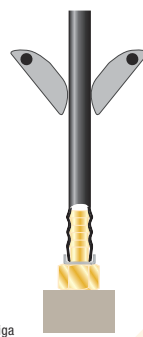

Reglamentaciones

Industriales:

- RoHS
- PED
- REACH

La selección del tubo auto-retráctil se hace por el Ø DN, por ejemplo:

Espiga acanalada	Ø ext. (tubo)	Ø DN (tubo)	Tubo auto-retráctil
0132 10 56	10	1/4	10..H 56...



Espigas acanaladas para tubo auto-retráctil

0132 Racor de espiga rápido para racor universal latón

Latón

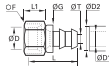

ØD	ØD1	ØD2		F	G	L	L1	ØT	Kg
6	6,3	13	0132 06 56	12	16,5	32,5	12,5	4,8	0,010
8	6,3	13	0132 08 56	14	16,5	29,5	11,5	4,8	0,015
10	6,3	13	0132 10 56	19	16,5	30	14	4,8	0,028
	9,5	16	0132 10 60	19	19,5	34	14	7,5	0,030
14	9,5	16	0132 14 60	24	19,5	35,5	15	7,5	0,050
	12,7	19	0132 14 62	24	23,5	39,5	15	10	0,054
18	12,7	19	0132 18 62	30	23,5	41,5	17	10	0,090
	15,9	23	0132 18 66	30	27	50	17	13,5	0,090
22	19,1	27	0132 22 69	36	30,5	56,5	17	16	0,130

Collarín de polímero técnico

0133..39 Racor de espiga rápido con junta bi-materia, rosca macho BSPP

Latón, Acero galvanizado con junta NBR

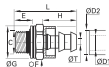

ØD1	ØD2	C		E	F	G	H	L	ØT	Kg
6,3	13	G1/8	0133 56 10 39	5,5	13	14	20	31,5	4,8	0,012
6,3	13	G1/4	0133 56 13 39	7	17	17	20	33,5	4,8	0,017
9,5	16	G1/4	0133 60 13 39	7	17	17	24	37,5	7,5	0,022
9,5	16	G3/8	0133 60 17 39	9,5	22	22	24	42,5	7,5	0,038
12,7	19	G3/8	0133 62 17 39	9,5	22	22	28	46,5	10	0,045
12,7	19	G1/2	0133 62 21 39	10,5	27	26	28	48,5	10	0,059
15,9	23	G1/2	0133 66 21 39	10,5	27	26	36,5	57	13,5	0,064
15,9	23	G3/4	0133 66 27 39	11,5	32	32	36,5	59	13,5	0,095
19,1	27	G3/4	0133 69 27 39	11,5	32	32	43	65,5	16	0,111

Collarín de polímero técnico, con junta bi-materia. Las juntas bi-materia referencia 0139 se encuentran en el subcapítulo "accesorios de conexión".

0134 Racor de espiga rápido, rosca macho BSPT

Latón

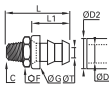

ØD1	ØD2	C		F	G	L	L1	ØT	Kg
6,3	13	R1/8	0134 56 10	14	16,5	32,5	20	4,8	0,015
6,3	13	R1/4	0134 56 13	14	16,5	37	20	4,8	0,020
9,5	16	R1/4	0134 60 13	14	19,5	41	24	7,5	0,022
9,5	16	R3/8	0134 60 17	19	19,5	41,5	24	7,5	0,036
12,7	19	R3/8	0134 62 17	19	23,5	45,5	28	10	0,038
12,7	19	R1/2	0134 62 21	22	23,5	50	28	10	0,062
15,9	23	R1/2	0134 66 21	22	27	58,5	36,5	13,5	0,056
15,9	23	R3/4	0134 66 27	27	27	60,5	36,5	13,5	0,101
19,1	27	R3/4	0134 69 27	27	30,5	67	43	16	0,108

Collarín de polímero técnico

Racores de compresión de acero inoxidable



Estos racores "universal" ofrecen una excelente resistencia a los ambientes y fluidos agresivos. Resisten las presiones y las temperaturas elevadas, así como los golpes de ariete y las vibraciones intensas. Adecuado para los fluidos alimenticios.

Ø métrico:
6 a 16 mm

Características técnicas

- **Fluidos adecuados:** Todos los tipos de fluidos
- **Presión de trabajo:** De vacío hasta 400 bar
80 bar en entornos agresivos)
- **Temperatura de trabajo:** -60°C a +250°C con tubos metálicos

Par de apriete de la tuerca	DN	6	8	10	12	16
	daN.m		2	3	4	6,5

Las prestaciones dependen de los fluidos y del tubo utilizados.
El uso está garantizado para un vacío de 755 mm Hg (99% de vacío).
El sellado de la rosca está bajo responsabilidad de los usuarios.

Ventajas

- Excelente estanqueidad y mantenimiento del racor en el tubo
- Ausencia de junta para garantizar una vida útil máxima
- Posibilidad de conectar fácilmente distintos tipos de tubos y diámetros a un mismo cuerpo de racor
- No se requiere refuerzo para los tubos de acero inoxidable y de poliamida rígida inferior a 12 mm
- Conexión de diferentes tipos de tuberías y tubos: metal, polímeros, acero, goma...
- Diseñado exclusivamente en acero inoxidable 316L

Combinaciones: Ø tubos / paso del fluido

La tabla siguiente indica los diámetros de paso máximos en función de las roscas de implantación en algunos ejemplos de diámetros de tubos.

Ø ext. del tubo	Rosca BSPP	Paso máximo
6	G1/8	4
6-8-10	G1/4	7
10-12	G3/8	11
16	G1/2	14

Longitudes de tubos para montaje

Longitud de tubo (L) mínimo a dejar entre 2 racores.



ØD	L mm	ØD	L mm
4	26,5	10	39
6	26	12	39
8	32	16	46,5

El uso de los racores de compresión Parker Legris está condicionado por los materiales de los tubos instalados. Se incluyen a continuación las tablas recapitulativas de las presiones de trabajo en función de los materiales de los tubos.

Tipo de tubo recomendado

Tubo de poliamida semi-rígido o de fluoropolímero

Tubo de acero inoxidable

Tubo "fino" estirado en frío, sin soldadura, hipertemplado, decapado y pasivado, con tolerancia sobre el espesor +/- 0,1 mm. Empleo exclusivo en tubos de acero inoxidable "finos" de Ø 6 a 16 mm exterior (espesor máximo 1 mm).

Tipo de configuraciones recomendadas para el montaje tubo/racores

Montaje realizado con anillo y tuerca Parker Legris de acero inoxidable y un refuerzo.

Tubo de acero inoxidable

Tubo de acero inoxidable: en barras rectas templadas en frío (resultados idénticos)
Tubo de acero inoxidable recocido en rollos: reducir la presión de trabajo en un 35 %; evitar totalmente en caso de vibraciones.

Materiales

Sin silicona

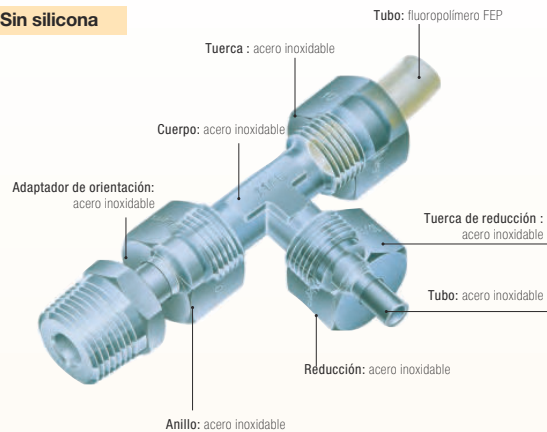

Reglamentaciones

- RoHS
- PED
- REACH
- 1935/2004

Racores de compresión de acero inoxidable

Tubo de poliamida semi-rígida

Presión máxima de trabajo de la conexión (bar)

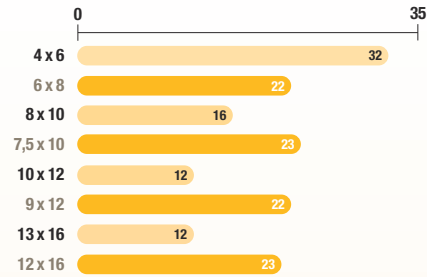

Tubo de acero inoxidable

Presión máxima de trabajo de la conexión (bar)

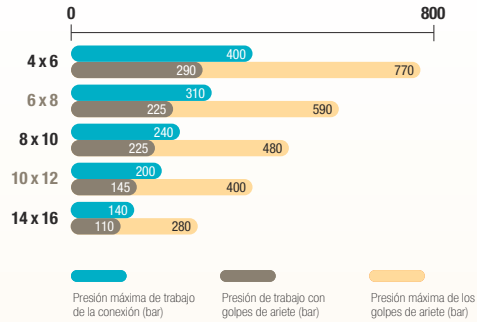

Coefficientes reductores de la presión de trabajo según la temperatura para tubos semi-rígidos

Temperaturas °C	-40°C / -15°C	-15°C / +30°C	+30°C / +50°C	+50°C/+70°C	+70°C/+100°C
Coefficientes	1,8	1	0,68	0,55	0,31

Las indicaciones anteriores resultan de nuestra amplia experiencia. Al ser cada uso un caso particular, no pueden comprometer nuestra responsabilidad y recomendamos a nuestros clientes realizar pruebas en las condiciones reales de uso.

Instalación

Montaje

El racor se compone de 3 piezas (cuerpo / anillo / tuerca). Para el esquema de las etapas de montaje, ver página "Racores de compresión de latón".

Esquema: producto acabado montado

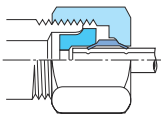

Cuando aparece una muy ligera deformación interior del tubo, significa que se ha logrado un buen engaste.

Montaje de codos orientables

Codo 1802 + Adaptador 1820 =

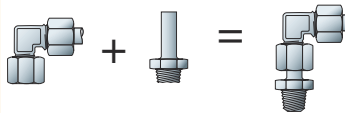

Racores especiales

Si los racores de compresión de acero inoxidable estándar no se pueden utilizar, Parker Legris puede estudiar, sobre un pliego de condiciones, racores específicos.

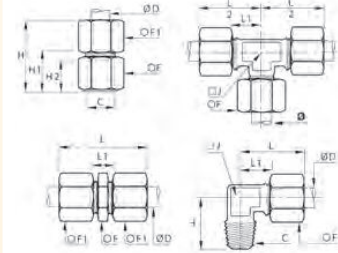

Racores de compresión de acero inoxidable

1805 Racor de entrada recto, rosca macho BSPT

Acero inox 316L

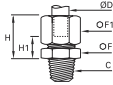

ØD	C	F	F1	H max	H1	Kg
6	R1/8 1805 06 10	12	13	19,5	7,5	0,017
	R1/4 1805 06 13	14	13	19,5	7,5	0,025
8	R1/8 1805 08 10	13	14	21	7	0,019
	R1/4 1805 08 13	14	14	21	7	0,024
10	R1/4 1805 10 13	17	19	25,5	9	0,043
	R3/8 1805 10 17	17	19	25,5	9	0,049
12	R1/2 1805 10 21	22	19	26,5	10	0,076
	R1/4 1805 12 13	19	22	26	9	0,054
16	R3/8 1805 12 17	19	22	26	9	0,057
	R1/2 1805 12 21	22	22	27	10	0,081
16	R3/8 1805 16 17	24	27	28,5	9,5	0,086
	R1/2 1805 16 21	24	27	28,5	9,5	0,093

1809 Codo, rosca macho BSPT

Acero inox 316L

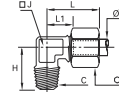

ØD	C	F	H	J	L max	L1	Kg
6	R1/8 1809 06 10	13	18	8	25,5	13,5	0,020
	R1/4 1809 06 13	13	23	10	25,5	13,5	0,029
8	R1/8 1809 08 10	14	20,5	10	28,5	14,5	0,026
	R1/4 1809 08 13	14	23	10	28,5	14,5	0,030
10	R1/4 1809 10 13	19	25	12	32,5	16	0,051
	R3/8 1809 10 17	19	25,5	12	32,5	16	0,057
12	R1/2 1809 10 21	19	32	18	36,5	20	0,091
	R1/4 1809 12 13	22	26	14	34,0	17	0,067
16	R3/8 1809 12 17	22	27	14	34,0	17	0,070
	R1/2 1809 12 21	22	32	18	37,0	20	0,098
16	R3/8 1809 16 17	27	28,5	18	39,5	21	0,107
	R1/2 1809 16 21	27	31,5	18	39,5	21	0,114

1805 Racor de entrada recto, rosca macho NPT

Acero inox 316L

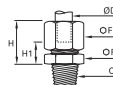

ØD	C	F	F1	H max	H1	Kg
6	NPT1/8 1805 06 11	12	13	19,5	7,5	0,018
	NPT1/4 1805 06 14	14	13	19,5	7,5	0,027
8	NPT3/8 1805 06 18	19	13	20,5	8,5	0,033
	NPT1/8 1805 08 11	13	14	21	7	0,021
10	NPT1/4 1805 08 14	14	14	21	7	0,027
	NPT1/4 1805 10 14	17	19	25,5	9	0,045
12	NPT3/8 1805 10 18	19	19	25,5	9	0,055
	NPT1/2 1805 10 22	22	19	26,5	10	0,082
16	NPT1/4 1805 12 14	19	22	26	9	0,057
	NPT3/8 1805 12 18	19	22	26	9	0,060
16	NPT1/2 1805 12 22	22	22	27	10	0,086

1809 Codo, rosca macho NPT

Acero inox 316L

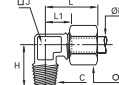

ØD	C	F	H	J	L max	L1	Kg
6	NPT1/4 1809 06 14	13	25,5	10	25,5	13,5	0,032
8	NPT1/8 1809 08 11	14	22	10	28,5	14,5	0,027
	NPT1/4 1809 08 14	14	25,5	10	28,5	14,5	0,032
10	NPT1/4 1809 10 14	19	27,5	12	32,5	16	0,053
	NPT3/8 1809 10 18	19	28	12	32,5	16	0,060
12	NPT1/2 1809 10 22	19	35	18	36,5	20	0,096
	NPT1/2 1809 12 22	22	35	18	37,0	20	0,101

1814 Racor de entrada recto, rosca hembra BSPP

Acero inox 316L

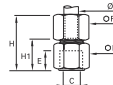

ØD	C	E	F	F1	H max	H1	Kg
6	G1/8 1814 06 10	7,5	14	13	29	17	0,024
	G1/4 1814 06 13	11	17	13	29	21	0,031
8	G1/4 1814 08 13	11	17	14	34,5	20,5	0,033
10	G3/8 1814 10 17	11,5	22	19	38,5	22	0,064
	G1/2 1814 10 21	15	27	19	43	26,5	0,094
12	G3/8 1814 12 17	11,5	22	22	39	22	0,073
	G1/2 1814 12 21	15	27	22	43,5	26,5	0,102
16	G1/2 1814 16 21	15	27	27	45	26	0,121

Racores de compresión de acero inoxidable

1820 Adaptador de orientación, rosca macho BSPT

Acero inox 316L

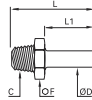

ØD	C		F	L	L1	Kg
6	R1/8	1820 06 10	12	26,5	15	0,009
	R1/4	1820 06 13	14	31	15	0,017
8	R1/8	1820 08 10	12	28,5	17	0,008
	R1/4	1820 08 13	14	33	17	0,016
10	R1/4	1820 10 13	14	36	20	0,016
	R3/8	1820 10 17	17	36,5	20	0,025
12	R1/2	1820 10 21	22	41	20	0,052
	R1/4	1820 12 13	14	36	20	0,016
	R3/8	1820 12 17	17	36,5	20	0,023
16	R1/2	1820 12 21	22	41	20	0,048
	R3/8	1820 16 17	17	39,5	23	0,022
	R1/2	1820 16 21	22	44	23	0,039

1820 Adaptador de orientación, rosca macho BSPT

Acero inox 316L



ØD	C		F	L	L1	Kg
8	NPT1/8	1820 08 11	12	28,5	17	0,009
	NPT1/4	1820 08 14	14	33	17	0,019
10	NPT1/4	1820 10 14	14	36	20	0,018
	NPT1/4	1820 12 14	14	36	20	0,019
12	NPT3/8	1820 12 18	19	36,5	20	0,028
	NPT1/2	1820 12 22	22	41	20	0,053

Racores de compresión de acero inoxidable



1806 Unión igual

Acero inox 316L

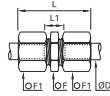

ØD		F	F1	L max	L1	Kg
6	1806 06 00	12	13	34,5	11	0,025
8	1806 08 00	13	14	38,5	10	0,029
10	1806 10 00	17	19	46	13	0,065
12	1806 12 00	19	22	47	13	0,085
16	1806 16 00	24	27	51	13	0,135

1816 Unión igual pasatabiques

Acero inox 316L

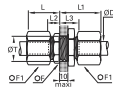

ØD		F	F1	L max	L1 max	L2	L3	ØT min	Kg
6	1816 06 00	13	13	28,0	19	7,5	17	10,5	0,034
8	1816 08 00	14	14	29,0	20	7	17	12,5	0,042
10	1816 10 00	19	19	33,0	25	9	19	16,5	0,093
12	1816 12 00	22	22	33,0	25	9	19	18,5	0,113
16	1816 16 00	27	27	36,0	28	9,5	19,5	22,5	0,179

1802 Codo igual

Acero inox 316L

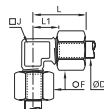

ØD		F	J	L max	L1	Kg
6	1802 06 00	13	8	25,5	13,5	0,027
8	1802 08 00	14	10	28,5	14,5	0,034
10	1802 10 00	19	12	32,5	16	0,070
12	1802 12 00	22	14	34,0	17	0,092
16	1802 16 00	27	18	39,5	21	0,151

1804 Te igual

Acero inox 316L

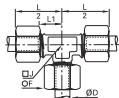

ØD		F	J	L/2	L1	Kg
6	1804 06 00	13	8	25,5	13,5	0,039
8	1804 08 00	14	10	28,5	14,5	0,049
10	1804 10 00	19	12	32,5	16	0,100
12	1804 12 00	22	14	34	17	0,133
16	1804 16 00	27	18	39,5	21	0,216

Racores de compresión de acero inoxidable

1866 Reducción tres piezas

Acero inox 316L

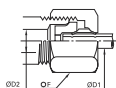

ØD1	ØD2		F	Kg
6	8	1866 06 08	14	0,011
	10	1866 06 10	19	0,027
8	10	1866 08 10	19	0,025

1824 Anillo de estanqueidad de acero inoxidable

Acero inox 316L



ØD		Kg
6	1824 06 00	0,002
8	1824 08 00	0,001
10	1824 10 00	0,003
12	1824 12 00	0,004
16	1824 16 00	0,005

1810 Tuerca de apriete de acero inoxidable

Acero inox 316L



ØD	C		F	L	Kg
6	M10x1	1810 06 00	13	11	0,007
8	M12x1	1810 08 00	14	13	0,008
10	M16x1.5	1810 10 00	19	15	0,017
12	M18x1.5	1810 12 00	22	15	0,024
16	M22x1.5	1810 16 00	27	17	0,041

1822 Espiga acanalada para tubo de caucho

Acero inox 316L

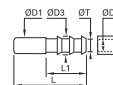

ØD1	ØD2	ØD3		L	L1	ØT min	Kg
6	7	9	1822 06 07	37,5	22,5	6	0,006
	6	8	1822 08 06	40	22,5	5	0,007
8	7	9	1822 08 07	40	22,5	6	0,007
	10	12,5	1822 08 10	40	22,5	9	0,011
10	7	9	1822 10 07	43	22,5	6	0,009
	10	12,5	1822 10 10	43	22,5	9	0,012
12	10	12,2	1822 12 10	43	22,5	9	0,012
	13	15	1822 12 13	50	29,5	13	0,015

1827 Refuerzo interior de acero inoxidable para tubo fluoropolímero

Acero inox 316L

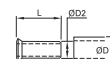

ØD1	ØD2		L	Kg
6	4	1827 06 00	11,5	0,001
8	6	1827 08 00	14	0,001
10	8	1827 10 00	18	0,001
12	9	1827 12 09	18	0,001
	10	1827 12 00	18	0,001
16	13	1827 16 13	18	0,002
	14	1827 16 00	18	0,002

Este refuerzo debe utilizarse obligatoriamente con el tubo de fluoropolímero FEP, a cualquier temperatura o presión que pueda soportar el conjunto de racor + tubo.

Racores de cánula de latón niquelado PL



Los racores PL adecuados para tubos flexibles son desmontables y reutilizables.

Ø métrico:
4 a 14 mm

Características técnicas

- **Fluidos adecuados:** aire comprimido
Otros fluidos: consúltenos
- **Presión de trabajo:** De vacío hasta 18 bar con tuerca BPLM-M
De vacío hasta 40 bar con tuerca BPLM
- **Temperatura de trabajo:** -40°C a +100°C

Par de apriete (Nm)	M5 x0,8	M6 x1	1/8	1/4	3/8	1/2
BSPT Thread			8	12	14	16
Roscas BSPP con "O" ring			1,2	1,5	2,5	3,5
Roscas BSPP con manguito de metal			5	8	10	12
Rosca métrica	0,8	0,8				

Las prestaciones dependen de los fluidos, del material y del tubo utilizados.
El uso está garantizado para un vacío de 755 mm Hg (99% de vacío).
Para una utilización con el tubo a prueba de fuego, consúltenos.

Materiales

Sin silicona

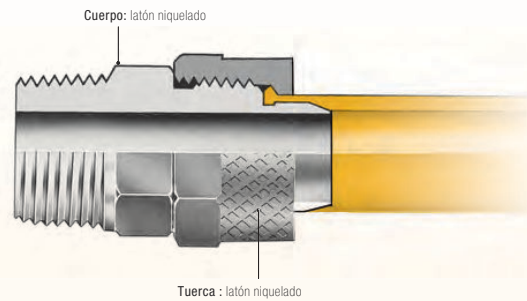

Ventajas

- Compatible con los tubos flexibles y semi-rígidos (poliuretano, poliamida, polietileno, fluoropolímeros...)
- Sistema de estanqueidad directo fiable, sin junta y sin anillo de anclaje
- Niquelado para una resistencia a la corrosión elevada

Instalación

Corte del tubo



Cortar el tubo de polímero en forma de codo.

Preparación de la conexión



Deslizar la tuerca de ajuste por el tubo.

Conexión del tubo



Empujar el tubo hasta el tope en el cuerpo del racor.

Montaje final



Enroscar la tuerca a fondo, a mano (en el caso de un tubo flexible) y con la llave (en el caso de un tubo semi-rígido) hasta el contacto con el cuerpo.

F3BPL Racor de entrada recto, macho BSPT

Latón niquelado



ØD	C		F	F1	H	Kg
2.7x4	R1/8	F3BPL2.7/4-1/8	12	8	16	0,009
4x6	R1/8	F3BPL4/6-1/8	12	12	19,5	0,016
	R1/4	F3BPL4/6-1/4	14	12	20	0,025
6x8	R1/8	F3BPL6/8-1/8	12	14	19,5	0,019
	R1/4	F3BPL6/8-1/4	14	14	20	0,026
8x10	R3/8	F3BPL6/8-3/8	17	14	20	0,030
	R1/4	F3BPL8/10-1/4	14	16	21,5	0,031
10x12	R3/8	F3BPL8/10-3/8	17	16	21,5	0,043
	R3/8	F3BPL10/12-3/8	17	18	23	0,036
11x14	R3/8	F3BPL11/14-3/8	22	22	23,5	0,061

Compatible con la tuerca BPLM-M únicamente

F4BPL Racor de entrada recto, macho BSPT

Latón niquelado, NBR



ØD	C		E	F	F1	H	Kg
4x6	G1/8	F4BPL4/6-1/8	6	13	12	19,5	0,031
6x8	G1/4	F4BPL6/8-1/4	8	16	14	20	0,033

Compatible con la tuerca BPLM-M únicamente

Racores de cánula de latón niquelado PL

F8BPL Racor de entrada recto, macho métrica

Latón niquelado, NBR



ØD	C		E	F	F1	H	Kg
6x8	M10x1	F8BPL6/8M10	8	14	13	20	0,025
	M12x1.25	F8BPL6/8M12	8	17	14	28	0,028

Compatible con la tuerca BPLM Los racores se entregan con una junta de cobre
Presión de trabajo máx.: 40 bar

C8BPL-1 Codo, rosca macho métrica

Latón niquelado, NBR

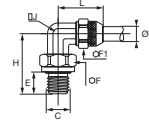

ØD	C		E	F	F1	H	J	L	Kg
6x8	M10x1	C8BPL6/8M10	6,5	14	14	22	10	23	0,030
	M12x1.25	C8BPL6/8M12X125	8	17	14	25	10	23	0,035

Los racores se suministran con juntas. El tornillo es de acero tratado. Compatible con la tuerca BPLM-M únicamente

C3BPL Codo, rosca macho BSPT

Latón niquelado

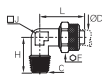

ØD	C		F	H	J	L	Kg
2.7x4	R1/8	C3BPL2.7/4-1/8	8	17	8	19,5	0,018
	R1/8	C3BPL4/6-1/8	12	17	8	22,5	0,022
4x6	R1/4	C3BPL4/6-1/4	12	20	10	22,5	0,031
	R1/8	C3BPL6/8-1/8	14	17	10	22,5	0,029
6x8	R1/4	C3BPL6/8-1/4	14	20	10	22,5	0,031
	R3/8	C3BPL6/8-3/8	14	22,5	11	24	0,064
7.5x10	R1/4	C3BPL7.5/10-1/4	16	22,5	12	28	0,057
	R1/4	C3BPL8/10-1/4	16	21,5	11	25,5	0,057
8x10	R3/8	C3BPL8/10-3/8	16	22,5	11	25,5	0,057
	R3/8	C3BPL10/12-3/8	18	24,5	14	30	0,060
11x14	R3/8	C3BPL11/14-3/8	22	28	14	34	0,075

Compatible con la tuerca BPLM-M únicamente

R3BPL Te, rosca macho lateral BSPT

Latón niquelado

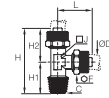

ØD	C		F	H	H1	H2	J	Kg
4x6	R1/8	R3BPL4/6-1/8	12	39,5	17	22,5	8	0,035
	R1/4	R3BPL4/6-1/4	12	43,5	21	22,5	10	0,048

Compatible con la tuerca BPLM-M únicamente

S3BPL Te, rosca macho central BSPT

Latón niquelado

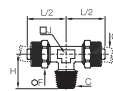

ØD	C		F	H	J	L/2	Kg
4x6	R1/8	S3BPL4/6-1/8	12	17	8	22,5	0,035
	R1/4	S3BPL4/6-1/4	12	20,5	10	22,5	0,047

Compatible con la tuerca BPLM-M únicamente

C4BPL Codo, rosca macho BSPP

Latón niquelado, NBR



ØD	C		E	F	F1	H	J	L	Kg
4x6	G1/4	C4BPL4/6-1/4	8	17		25	10	23,5	0,066
6x8	G1/4	C4BPL6/8-1/4	8	17	14	25	10	23,5	0,068

Los racores se suministran con juntas. El tornillo es de acero tratado. Compatible con la tuerca BPLM-M únicamente

COR4BPL Banjo simple, rosca macho BSPP

Latón niquelado, Acero tratado, NBR

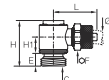

ØD	C		E	F	H	H1	L	Kg
4x6	G1/8	COR4BPL4/6-1/8	6,5	12	25,5	9	24	0,069
	G1/4	COR4BPL4/6-1/4	8	12	31,5	10	26	0,097
6x8	G1/4	COR4BPL6/8-1/4	8	14	31,5	10	26	0,101
	G1/8	COR4BPL6/8-1/8	6,5	14	25,5	9	24	0,073

Los racores se suministran con juntas. El tornillo es de acero tratado. Compatible con la tuerca BPLM-M únicamente

Racores de cánula de latón niquelado PL



HBPL Unión doble igual

Latón niquelado



ØD		F	F1	L	Kg
2.7x4	HBPL2.7/4	8	8	26	0,010
4x6	HBPL4/6	12	12	34,5	0,021
6x8	HBPL6/8	14	14	35	0,030
8x10	HBPL8/10	14	16	38	0,043
10x12	HBPL10/12	17	18	41	0,056

Compatible con la tuerca BPLM-M únicamente

BPLM Tuerca de apriete

Latón niquelado

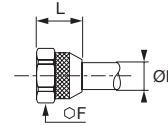

ØD	C		E	F	L	Kg
2.7x4	M6x0,50	BPL4M	6	8	8	0,003
4x6	M8x0,75	BPL6M	6,5	9	9	0,006
6x8	M12x1	BPL8M	7,5	14	10,5	0,009
8x10	M14x1	BPL10M	8	16	11,5	0,014

Presión de trabajo máx.: 40 bar

JBPL Te igual

Latón niquelado



ØD		F	H	J	L/2	Kg
4x6	JBPL4/6	12	22,5	8	22,5	0,042
6x8	JBPL6/8	14	22,5	10	22,5	0,057

Compatible con la tuerca BPLM-M únicamente

BPLM-M Tuerca de apriete

Latón niquelado



ØD	C		F	L	Kg
4x6	M8x0,75	BPL6M-1	9	9	0,006
6x8	M12x1	BPL8M-1	14	10,5	0,008
8x10	M14x1	BPL10M-1	16	11,5	0,012

WBPL Unión doble igual, pasatabiques

Latón niquelado

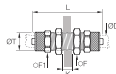

ØD		F	F1	K max	L	ØT	Kg
4x6	WBPL4/6	14	12	10,5	48	10	0,030
6x8	WBPL6/8	16	14	10,5	48	12	0,040
8x10	WBPL8/10	17	16	8,5	50	14	0,057

Compatible con la tuerca BPLM-M únicamente

Racores de cánula de latón niquelado PL, acero inoxidable o compuesto

MV Racores de implantación hembra

Latón

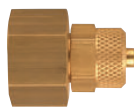

ØD	C		HEX	L
4x6	G1/8	MV10/06	14	23
	G1/4	MV13/06	17	25
6x8	G1/4	MV13/08	17	25

EV Racores de implantación

Latón

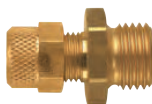

ØD	C		HEX	L	Versión
3x4	M5	EV05/04	7	20	Latón
3x5	M5	EV05/05	7	20	Latón
4x6	M5	EV05/06	8	21	Latón
	G1/8	EV10/06	12	25	Latón
6x8	G1/8	EV10/08	14	24	Latón
4x6	G1/4	EV13/06	17	26	Latón
6x8	G1/4	EV13/08	17	26	Latón
8x10	G1/4	EV13/10	17	31	Latón
9x12	G1/4	EV13/12	17	31	Latón
	G3/8	EV17/12	19	31	Latón

EV Racores de implantación

Acero inoxidable



ØD	C		HEX	L	Versión
3x4	M5	EV05/04R	7	20	AISI 303
3x5	M5	EV05/05R	7	20	AISI 303
4x6	M5	EV05/06R	8	21	AISI 303
	G1/8	EV10/06R	12	25	AISI 303
6x8	G1/8	EV10/08R	14	24	AISI 303

EV Racores de cánula con la tuerca de plástico

POM ou PVDF

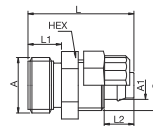

ØD	C		HEX	G	L	L1	L2	Versión
4x6	G1/4	EV13/06DX	14	M 10 x 1	25	8	13	POM
6x8	G1/4	EV13/08DX	14	M 12 x 1	25	8	13	POM
4x6	G1/4	EV13/06FX	14	M 10 x 1	25	8	13	PVDF
6x8	G1/4	EV13/08FX	14	M 12 x 1	25	8	13	PVDF

EK Espiga acanalada plástico y pasatabiques

POM ou PVDF

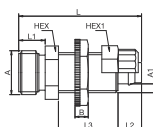

ØD	C		HEX	HEX1	B	G	L	L1	L2	L3	Versión
4x6	G1/4	EK13/06DX	14	14	4	M 10 x 1	37	7	8	18	POM
6x8	G1/4	EK13/08DX	14	17	4	M 12 x 1	37	8	8	18	POM
4x6	G1/4	EK13/06FX	14	14	4	M 10 x 1	37	7	8	18	PVDF
6x8	G1/4	EK13/08FX	14	17	4	M 12 x 1	37	8	8	18	PVDF

ACCESORIOS ROSCADOS Y REGLETAS DE DISTRIBUCIÓN

Accesorios roscados y regletas de distribución

	Materiales	Fluidos	Presión máxima (bar)	Temperatura		Resistencia en entornos agresivos		Página
				Min.	Máx.	Mecánica	Química	
Accesorios roscados y regletas de distribución								
Adaptadores en latón niquelado 	Latón niquelado	Aire comprimido	60	-10°C	+80°C	Buena	Moderada	163
Adaptadores en latón 	Latón	Aire comprimido	200	-40°C	+150°C	Buena	Moderada	168
Adaptadores en acero inoxidable 	Acero inoxidable 316L	Todos los fluidos	200	-20°C	+180°C	Excelente	Excelente	173
Regletas de distribución 	Aluminio anodizado, latón	Aire comprimido	20	-10°C	+80°C	Excelente	Buena	176
Tapones roscados 	Latón, latón niquelado, acero inoxidable, acero	Todos los fluidos (dependiendo de los materiales)	200	-60°C	+180°C	Excelente	Moderada a Excelente	178
Accesorios 	FKM, cobre, polímero	Todos los fluidos (dependiendo de los materiales)	250	-250°C	+260°C		Excelente	182

Adaptadores de latón niquelado

0912 Codo igual, rosca hembra BSPP y métrica

Latón niquelado

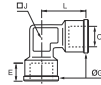

C	E	G	J	L	Kg
M5x0,8 0912 00 19	4	8	9	11	0,007
G1/8 0912 00 10	8	13	10	18,5	0,015
G1/4 0912 00 13	11,5	17	12	22,5	0,029
G3/8 0912 00 17	11,5	21	15	25,5	0,043
G1/2 0912 00 21	14	26	19	30	0,073
G3/4 0912 00 27	16,5	32	22	35,5	0,106
G1 0912 00 34	18	38,5	28	40,5	0,165

0921 Codo igual, rosca hembra / macho métrica

Latón niquelado



C	E	G	H	J	L	Kg
M5x0,8 0921 00 19	4	8	11,5	9	11	0,007

0913 Codo igual, rosca macho BSPT / hembra BSPP

Latón niquelado

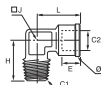

C1	C2	E	G	H	J	L	Kg	
R1/8	G1/8	0913 00 10	8	13	17	10	18,5	0,012
R1/4	G1/4	0913 00 13	11,5	17	22,5	12	22,5	0,025
R3/8	G3/8	0913 00 17	11,5	21	25,5	15	25,5	0,040
R1/2	G1/2	0913 00 21	14	26	30	19	30	0,064
R3/4	G3/4	0913 00 27	16,5	32	34,5	22	35,5	0,098
R1	G1	0913 00 34	18	38,5	40,5	28	40,5	0,162

0914 Codo igual, rosca macho BSPT

Latón niquelado



C	H	J	L	Kg
R1/8 0914 00 10	17	10	17	0,010
R1/4 0914 00 13	22,5	12	22,5	0,022
R3/8 0914 00 17	25,5	15	25,5	0,034
R1/2 0914 00 21	30	19	30	0,057
R3/4 0914 00 27	34,5	22	34,5	0,093
R1 0914 00 34	40,5	28	40,5	0,157

0910 Y igual, rosca hembra BSPP

Latón niquelado



C	E	F	H	Kg
G1/8 0910 00 10	8	13	12	0,019
G1/4 0910 00 13	11	17	14	0,033
G3/8 0910 00 17	11,5	20	16	0,046
G1/2 0910 00 21	14	25	19	0,085

0911 Y igual, rosca macho central BSPT / hembra BSPP

Latón niquelado

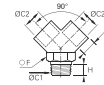

C1	C2	E	F	H	Kg	
R1/8	G1/8	0911 00 10	8	13	8	0,022
R1/4	G1/4	0911 00 13	11	17	11	0,038
R3/8	G3/8	0911 00 17	11,5	20	11,5	0,051
R1/2	G1/2	0911 00 21	14	25	14	0,105

0915 Te igual, rosca hembra BSPP y métrica

Latón niquelado



C	E	G	H	J	L/2	Kg
M5x0,8 0915 00 19	5	8	11	9	11	0,010
G1/8 0915 00 10	8	13	18,5	10	18,5	0,021
G1/4 0915 00 13	11	17	22,5	12	22,5	0,042
G3/8 0915 00 17	11,5	21	25,5	15	25,5	0,062
G1/2 0915 00 21	14	26	30	19	30	0,097
G3/4 0915 00 27	16,5	32	35,5	22	35,5	0,145
G1 0915 00 34	18	38,5	40,5	28	40,5	0,238

0916 Te igual, rosca macho central BSPT / hembra BSPP

Latón niquelado

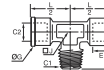

C1	C2	E	G	H	J	L/2	Kg	
R1/8	G1/8	0916 00 10	8	13	17	10	18	0,019
R1/4	G1/4	0916 00 13	11	17	22,5	12	22,5	0,038
R3/8	G3/8	0916 00 17	11,5	21	25,5	15	25,5	0,058
R1/2	G1/2	0916 00 21	14	26	30	19	30	0,091
R3/4	G3/4	0916 00 27	16,5	32	34,5	22	35	0,139

Adaptadores de latón niquelado

0917 Te igual, rosca macho lateral BSPT / hembra BSPP

Latón niquelado

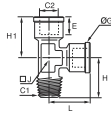

C1	C2		E	G	H	H1	J	L	Kg
R1/8	G1/8	0917 00 10	8	13	17	18,5	10	18,5	0,019
R1/4	G1/4	0917 00 13	11	17	22,5	22,5	12	22,5	0,038
R3/8	G3/8	0917 00 17	11,5	21	25,5	25,5	15	25,5	0,058
R1/2	G1/2	0917 00 21	14	26	30	30	19	30	0,089
R3/4	G3/4	0917 00 27	16,5	32	34,5	35,5	22	35,5	0,136

0927 Te igual, rosca macho BSPT

Latón niquelado

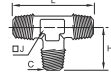

C		H	J	L	Kg
R1/8	0927 00 10	17	10	34	0,013
R1/4	0927 00 13	22,5	12	45	0,032
R3/8	0927 00 17	25,5	15	51	0,056
R1/2	0927 00 21	30	19	60	0,079
R3/4	0927 00 27	34,5	22	69	0,130

0928 Te igual, rosca macho BSPT / hembra central BSPP

Latón niquelado

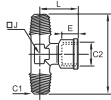

C1	C2		E	H	J	L	Kg
R1/8	G1/8	0928 00 10	8	34	10	18,5	0,016
R1/4	G1/4	0928 00 13	11	45	12	22,5	0,035
R3/8	G3/8	0928 00 17	11,5	51	15	25,5	0,053
R1/2	G1/2	0928 00 21	14	60	19	30	0,086
R3/4	G3/4	0928 00 27	16,5	69	22	35,5	0,236

0932 Te igual, rosca macho BSPT / hembra central BSPP

Latón niquelado

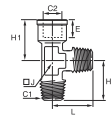

C1	C2		E	H	H1	J	L	Kg
R1/8	G1/8	0932 00 10	8	17	18,5	10	17	0,016
R1/4	G1/4	0932 00 13	11	22,5	22,5	12	22,5	0,035
R3/8	G3/8	0932 00 17	11,5	25,5	25,5	15	25,5	0,053
R1/2	G1/2	0932 00 21	14	30	30	19	30	0,091
R3/4	G3/4	0932 00 27	16,5	34,5	35,5	22	34,5	0,080

0908 Cruz igual, rosca hembra BSPP

Latón niquelado

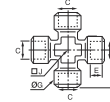

C		E	G	H	J	Kg
G1/8	0908 00 10	8	13	21	10	0,038
G1/4	0908 00 13	11	17	25,5	13	0,074
G3/8	0908 00 17	11,5	21	28	17	0,109
G1/2	0908 00 21	14	26	33,5	21	0,186

0909 Cruz igual, rosca macho BSPT / hembra BSPP

Latón niquelado

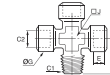

C1	C2		E	G	H	J	Kg
R1/8	G1/8	0909 00 10	8	13	18,5	10	0,034
R1/4	G1/4	0909 00 13	11	17	23,5	13	0,069
R3/8	G3/8	0909 00 17	11,5	21	26	17	0,098
R1/2	G1/2	0909 00 21	14	26	31	21	0,168

0178 Reducción, rosca macho BSPP / hembra BSPP y métrica

Latón niquelado, NBR

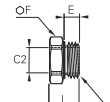

C1	C2		E	F	L	Kg
M7x1	M5x0,8	0178 55 19	5	10	12	0,005
G1/8	M5x0,8	0178 10 19	5	13	9	0,005
G1/4	G1/8	0178 13 10	5,5	16	9,5	0,006
G3/8	G1/8	0178 17 10	5,5	20	10,5	0,016
G3/8	G1/4	0178 17 13	5,5	20	10,5	0,011
G1/2	G1/4	0178 21 13	7,5	24	12,5	0,024
G1/2	G3/8	0178 21 17	7,5	24	12,5	0,016
G3/4	G1/2	0178 27 21	7,5	32	13,5	0,035

Con junta de estanqueidad

0903 Ampliador, rosca macho BSPT / hembra BSPP

Latón niquelado

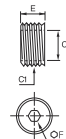

C1	C2		E	F	Kg
G1/4	G1/8	0903 10 13	8	6	0,004
G3/8	G1/4	0903 13 17	9	8	0,007
G1/2	G3/8	0903 17 21	10	10	0,011
G3/4	G1/2	0903 21 27	14	12	0,023
G1	G3/4	0903 27 34	20	17	0,038

Adaptadores de latón niquelado

0904 Reducción, macho BSPT/ hembra BSPP

Latón niquelado



C1	C2		F	L	Kg
R1/4	G1/8	0904 10 13	14	16	0,010
R3/8	G1/8	0904 10 17	17	16,5	0,020
R1/2	G1/8	0904 10 21	22	19,5	0,035
R3/8	G1/4	0904 13 17	17	16,5	0,015
R1/2	G1/4	0904 13 21	22	19,5	0,031
R1/2	G3/8	0904 17 21	22	19,5	0,024
R3/4	G3/8	0904 17 27	27	23	0,056
R3/4	G1/2	0904 21 27	27	23	0,045
R1	G1/2	0904 21 34	34	27	0,101
R1	G3/4	0904 27 34	34	27	0,074

0905 Reducción, macho BSPP/ hembra BSPP y métrica

Latón niquelado

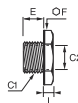

C1	C2		E	F	L	Kg
G1/8	M5x0,8	0905 19 10	6	14	4,5	0,008
G1/4	G1/8	0905 10 13	8	17	5	0,011
G3/8	G1/8	0905 10 17	9	19	5	0,019
	G1/4	0905 13 17	9	19	5	0,013
G1/2	G1/4	0905 13 21	10	24	5,5	0,031
	G3/8	0905 17 21	10	24	5,5	0,022
G3/4	G3/8	0905 17 27	11	30	6,5	0,055
	G1/2	0905 21 27	11	30	6,5	0,041

* Para esquemas detallados de la rosca interior, sírvanse consultarnos.

0906 Ampliador, rosca macho BSPP y métrica / hembra BSPP

Latón niquelado

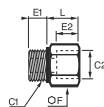

C1	C2		E1	E2	F	L	Kg
M5x0,8	G1/8	0906 10 19	4	8,0	14	10,5	0,010
G1/8	G1/8	0906 00 10	6	8,0	14	10,5	0,011
	G1/4	0906 10 13	6	11,0	17	13,5	0,017
G1/4	G3/8	0906 10 17	6	11,5	22	14,5	0,029
	G1/2	0906 13 17	8	11,0	17	13,5	0,019
G1/4	G3/8	0906 13 17	8	11,5	22	14,5	0,032
	G1/2	0906 13 21	8	14,0	24	18	0,037
G3/8	G3/8	0906 00 17	9	11,5	22	14,5	0,035
	G1/2	0906 17 21	9	14,0	24	18	0,038
G1/2	G1/2	0906 00 21	10	14,0	26	20	0,053

0933 Ampliador, rosca macho BSPT / hembra BSPP

Latón niquelado

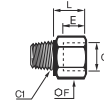

C1	C2		F	L	Kg
R1/8	G1/8	0933 00 10	14	10	0,011
R1/4	G1/4	0933 00 13	17	13,5	0,020
R3/8	G3/8	0933 00 17	22	14,5	0,037
R1/2	G1/2	0933 00 21	26	18	0,058
R1/8	G1/4	0933 10 13	17	13,5	0,017
R1/4	G3/8	0933 13 17	22	14,5	0,034
R1/4	G1/2	0933 13 21	24	18	0,038
R3/8	G1/2	0933 17 21	24	18	0,041
R1/2	G3/4	0933 21 27	32	23,5	0,080

0907 Prolongador igual, rosca macho BSPP / hembra BSPP

Latón niquelado



C		E	F	L	Kg
G1/8	0907 00 10	6	14	16	0,015
	0907 00 10 01	6	14	36	0,030
G1/4	0907 00 13	8	17	27	0,031
	0907 00 13 01	8	17	43	0,047

0920 Pasatabiques igual, rosca hembra BSPP y métrica

Latón niquelado

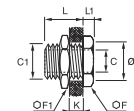

C	C1		F	F1	K max	L	L1	ØT	Kg
M5x0,8	M10x1	0920 00 19	14	14	7,0	10,5	3,5	10,5	0,012
G1/8	M16x1,5	0920 00 10	19	22	10,0	14	4	16,5	0,030
G1/4	M20x1,5	0920 00 13	24	27	16,0	21	4	20,5	0,057
G3/8	M26x1,5	0920 00 17	30	32	15,0	21	5	26,5	0,096
G1/2	M28x1,5	0920 00 21	32	36	21,0	27	6	28,5	0,115

Adaptadores de latón niquelado

0900 Unión igual y Desigual, rosca macho BSPT

Latón niquelado



C1	C2		F	L	Kg
R1/8	R1/8	0900 00 10	12	20,5	0,009
	R1/4	0900 10 13	14	24	0,014
	R3/8	0900 10 17	17	24,5	0,020
R1/4	R1/4	0900 00 13	14	27	0,017
	R3/8	0900 13 17	17	27,5	0,026
R3/8	R1/2	0900 13 21	22	30,5	0,046
	R3/8	0900 00 17	17	28	0,025
R1/2	R1/2	0900 17 21	22	31	0,046
	R1/2	0900 00 21	22	33,5	0,042
R3/4	R3/4	0900 21 27	27	37	0,084
	R3/4	0900 00 27	27	39,5	0,079
R1	R1	0900 27 34	34	42,5	0,145
	R1	0900 00 34	34	45,5	0,153

0901 Unión igual y Desigual, rosca macho BSPP y métrica

Latón niquelado



C1	C2		E	E1	F	L	Kg
M5x0,8	M5x0,8	0901 00 19	4	4	8	11,5	0,002
	G1/8	0901 19 10	4	6	14	14,5	0,008
G1/8	G1/8	0901 00 10	6	6	14	16,5	0,009
	G1/4	0901 10 13	6	8	17	19	0,016
G1/4	G1/4	0901 00 13	8	8	17	21	0,019
	G3/8	0901 13 17	8	9	19	22	0,023
G3/8	G1/2	0901 13 21	8	10	24	23,5	0,036
	G3/8	0901 00 17	9	9	19	23	0,025
G1/2	G1/2	0901 17 21	9	10	24	24,5	0,038
	G1/2	0901 00 21	10	10	24	25,5	0,040

0192 Unión desigual, rosca macho BSPT / macho BSPP

Latón niquelado



C1	C2		E	F	L	Kg
R1/8	G1/4	0192 10 13	9,5	17	23,5	0,019
R1/4	G1/4	0192 13 13	9,5	17	27,5	0,024
	G1/2	0192 13 21	11	27	31,5	0,066
R3/8	G1/4	0192 17 13	9,5	17	28	0,025
	G1/2	0192 17 21	11	27	31,5	0,060
R1/2	G1/2	0192 21 21	11	27	34	0,061

0191 Espiga acanalada para tubo de caucho, rosca macho BSPP

Latón niquelado



ØD	ØD1	C		E	F	K	L	Kg
4	6	G1/4	0191 04 13	9,5	17	5	22,5	0,019
	9	G1/4	0191 07 13	9,5	17	5	22,5	0,022
7	9	G1/2	0191 07 21	11	27	7	29,5	0,058
	12,2	G1/4	0191 10 13	9,5	17	5	22,5	0,020
10	12,2	G1/2	0191 10 21	11	27	7	29,5	0,060
	15,2	G1/4	0191 13 13	9,5	17	5	22,5	0,022
13	15,2	G1/2	0191 13 21	11	27	7	29,5	0,059
	16	G1/2	0191 16 21	11	27	7	36,5	0,067

0931 Espiga acanalada para tubo de caucho, rosca macho BSPP

Latón niquelado

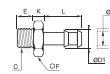

ØD	ØD1	C		E	F	K	L	Kg
6	7	G1/8	0931 06 10	6	12	4,5	19	0,009
	7	G1/4	0931 06 13	8	14	5	19	0,013
7	8	G1/8	0931 07 10	6	12	4	19	0,009
	8	G1/4	0931 07 13	8	14	5	19	0,014
	8	G3/8	0931 07 17	9	19	5	19	0,021
8	9	G1/8	0931 08 10	6	12	4	19	0,009
	9	G1/4	0931 08 13	8	14	5	19	0,014
10	9	G3/8	0931 08 17	9	19	5	19	0,022
	12	G1/4	0931 10 13	8	14	5	19	0,016
	12	G3/8	0931 10 17	9	19	5	19	0,024
15	12	G1/2	0931 10 21	10	22	6	20	0,031
	17	G3/8	0931 15 17	9	19	6	24	0,030
18	17	G1/2	0931 15 21	10	22	6	24	0,036
	20	G1/2	0931 18 21	10	22	6	24	0,040

Adaptadores de latón niquelado

0934 Espiga acanalada para tubo de polímero, rosca macho BSPT

Latón niquelado

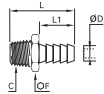

ØD	C		F	L	L1	Kg
6	R1/8	0934 06 10	12	31,5	19	0,009
	R1/4	0934 06 13	14	35	19	0,014
7	R1/8	0934 07 10	12	31,5	19	0,009
	R1/4	0934 07 13	14	35	19	0,014
8	R1/8	0934 08 10	12	31,5	19	0,010
	R1/4	0934 08 13	14	35	19	0,015
9	R1/4	0934 09 13	14	35	19	0,015
	R3/8	0934 09 17	17	35,5	19	0,021
	R1/2	0934 09 21	22	38,5	19	0,032
10	R1/8	0934 10 10	12	32,5	20	0,011
	R1/4	0934 10 13	14	36	20	0,016
	R3/8	0934 10 17	17	36,5	20	0,021
12	R1/2	0934 10 21	22	39,5	20	0,033
	R1/4	0934 12 13	14	36	20	0,016
	R3/8	0934 12 17	17	36,5	20	0,021
14	R1/2	0934 12 21	22	39,5	20	0,033
	R3/8	0934 14 17	17	38,5	22	0,025
16	R1/2	0934 14 21	22	41,5	22	0,036
	R3/8	0934 16 17	17	38,5	22	0,026
	R1/2	0934 16 21	22	41,5	22	0,037
17	R3/4	0934 16 27	27	45	22	0,055
	R1/2	0934 17 21	22	43,5	24	0,041
18	R3/8	0934 18 17	19	40,5	24	0,035
	R1/2	0934 18 21	22	43,5	24	0,044
	R3/4	0934 18 27	27	47	24	0,064
20	R1/2	0934 20 21	22	43,5	24	0,041

0902 Unión igual y desigual, rosca hembra BSPP y métrica

Latón niquelado

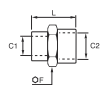

C1	C2		F	L	Kg
M5x0,8	M5x0,8	0902 00 19	8	11	0,003
	G1/8	0902 19 10	14	13,5	0,009
	G1/8	0902 00 10	14	15	0,010
G1/8	G1/4	0902 10 13	17	19	0,017
	G3/8	0902 10 17	22	20	0,028
G1/4	G1/4	0902 00 13	17	22	0,019
	G3/8	0902 13 17	22	22,5	0,031
	G1/2	0902 13 21	26	24	0,033
G3/8	G3/8	0902 00 17	22	23	0,035
	G1/2	0902 17 21	24	26	0,036
G1/2	G1/2	0902 00 21	26	28	0,049
	G3/4	0902 21 27	32	30	0,078
G3/4	G3/4	0902 00 27	32	32	0,076

0935 Espiga acanalada para tubo de polímero, rosca hembra BSPP

Latón niquelado

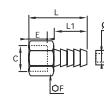

ØD	C		E	F	L	L1	Kg
6	G1/8	0935 06 10	8	12	28,5	19	0,007
8	G1/4	0935 08 13	11	15	31,5	19	0,012
12	G1/2	0935 12 21	14,5	24	36	20	0,033

0950MB Kit de mantenimiento, BSPP

Latón niquelado



	H	L	L1	Kg
0950 00 00 02	81	413	330	3,500

Una selección de 250 referencias entre los productos más utilizados

0950MO Kit de mantenimiento, BSPP

Latón niquelado



	H	L	L1	Kg
0950 00 00 03	81	413	330	3,500

Una selección de 250 referencias entre los productos más utilizados

Adaptadores de latón

0143 Codo igual, rosca hembra BSPP

Latón



C	E	G	J	L	Kg
G1/8 0143 10 10	7,5	16,5	12	22,5	0,043
G1/4 0143 13 13	11	18,5	15	26,5	0,056
G3/8 0143 17 17	11,5	23,5	19	31,5	0,102
G1/2 0143 21 21	15	28	23	34,5	0,150
G3/4 0143 27 27	16,5	34	27	43,5	0,248

0144 Codo igual, rosca macho BSPT / hembra BSPP

Latón



C1	C2	E	G	H	J	L	Kg	
R1/8	G1/8	0144 10 10	7,5	16,5	23	12	22,5	0,036
R1/4	G1/4	0144 13 13	11	18,5	26	15	26,5	0,056
R3/8	G3/8	0144 17 17	11,5	23,5	30	19	31,5	0,086
R1/2	G1/2	0144 21 21	15	28	35	23	34,5	0,139
R3/4	G3/4	0144 27 27	16,5	34	40	27	43,5	0,227

0152 Codo igual, rosca macho BSPT

Latón



C	H	J	L	Kg
R1/8 0152 10 10	19,5	10	19,5	0,018
R1/4 0152 13 13	25	15	25	0,047
R3/8 0152 17 17	26,5	15	26,5	0,054
R1/2 0152 21 21	31,5	19	31,5	0,089
R3/4 0152 27 27	35,5	23	35,5	0,153

0145 Codo igual, rosca hembra BSPP

Latón



C	E	G	H	J	L/2	Kg
G1/8 0145 10 10	7,5	16,5	22,5	12	22,5	0,057
G1/4 0145 13 13	11	18,5	26,5	15	26,5	0,078
G3/8 0145 17 17	11,5	23,5	31	19	31	0,126
G1/2 0145 21 21	15	28	38	23	38	0,244
G3/4 0145 27 27	16,5	34	47,5	27	47,5	0,370

MR0434 Te, rosca lateral hembra BSPP, macho BSPT

Latón

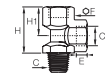

C	C1	E	F	H	H1	Kg	
R1/8	G1/8	1/8MR0434B	8	14	32	15	0,029
R1/4	G1/4	1/4MR0434B	10	17	40	18	0,050
R1/2	G1/2	1/2MR0434B	14	30	63	31	0,254

0158 Te hembra, rosca BSPP - macho central rosca BSPT

Latón

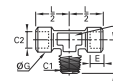

C1	C2	E	G	H	J	L/2	Kg	
R1/8	G1/8	0158 10 10	7,5	16,5	21,5	12	21,5	0,048
R1/4	G1/4	0158 13 13	11	18,5	26	15	26	0,072
R3/8	G3/8	0158 17 17	11,5	23,5	30	19	30	0,120
R1/2	G1/2	0158 21 21	15	28	36	23	36	0,205
R3/4	G3/4	0158 27 27	16,5	34	44	27	44	0,310

0117 Pasatabiques igual, rosca hembra BSPP y métrica

Latón

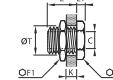

C	F	F1	K max	L	L1	ØT	Kg
M5x0,8 0117 00 19	14	14	7,0	10,5	3,5	10,5	0,012
G1/8 0117 00 10	19	22	9,0	14	4	16,5	0,032
G1/4 0117 00 13	24	27	15,0	21	4	20,5	0,056
G3/8 0117 00 17	30	32	14,0	21	5	26,5	0,096
G1/2 0117 00 21	32	36	20,0	27	6	28,5	0,115
G3/4 0117 00 27	41	41	22,5	30	6	34,5	0,161
G1 0117 00 34	46	50	24,5	34	8	42,5	0,269
G1 1/4 0117 00 42	55	55	29,5	39	8	49,5	0,295
G1 1/2 0117 00 49	60	60	29,5	39	8	54,5	0,303

Entregado con tuercas no ensambladas

Adaptadores de latón

207ACBH Pasatabiques igual, rosca hembra NPTF

Latón

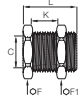

C	F	F1	K	L	Kg
NPTF1/8 207ACBH-2	7/8	15/16	20	38	0,072
NPTF1/4 207ACBH-4	1	1.1/8	18	38	0,099
NPTF3/8 207ACBH-6	1.1/8	1.1/4	13	34	0,127
NPTF1/2 207ACBH-8	1.1/4	1.3/8	16	38	0,155

F y F1 son dimensiones en pulgadas

0155 Manguito hexagonal, rosca hembra BSPP

Latón

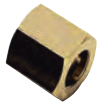

C	C1	F	L	Kg
G1/8	0155 10 10	14	17	0,014
G1/4	G1/8 0155 10 13	17	18	0,022
	0155 13 13	17	24	0,025
G3/8	0155 17 17	22	25	0,045
G1/2	0155 21 21	27	32	0,084
G3/4	0155 27 27	32	35	0,108
G1	0155 34 34	41	36	0,194

207P Manguito igual, rosca hembra NPTF, serie pesada

Latón



C	F*	L	Kg
NPTF1/8 207P-2	9/16	19	0,015
NPTF1/4 207P-4	3/4	28	0,041
NPTF3/8 207P-6	7/8	28	0,049
NPTF1/2 207P-8	1.1/16	38	0,089

* Dimensiones de F a pulgadas

0164 Adaptador, rosca macho NPT / hembra BSPP

Latón



C1	C2	E	F	L	Kg
NPT1/8	G1/8 0164 11 10	7,5	14	20	0,015
NPT1/4	G1/4 0164 14 13	11	17	27,5	0,028
NPT3/8	G3/8 0164 18 17	11,5	22	28,5	0,044
NPT1/2	G1/2 0164 22 21	15	27	36,5	0,081
NPT3/4	G3/4 0164 28 27	16,5	32	38,5	0,110

El número de salidas de tubo del cuerpo hembra debe ser igual al del cuerpo macho.

0167 Adaptador, rosca macho BSPT / hembra NPT

Latón

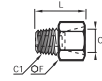

C1	C2	F	L	Kg
R1/8	NPT1/8 0167 10 11	14	21	0,016
R1/4	NPT1/4 0167 13 14	17	28,5	0,029
R3/8	NPT3/8 0167 17 18	22	29,5	0,047
R1/2	NPT1/2 0167 21 22	27	37,5	0,088
R3/4	NPT3/4 0167 27 28	32	39,5	0,119

El número de salidas de tubo del cuerpo hembra debe ser igual al del cuerpo macho.

0168 Reducción, rosca macho BSPP / hembra BSPP y métrica

Latón, Polímero técnico



C1	C2	E	F	H	Kg
G1/8	M5x0,8 0168 10 19	7	14	6	0,009
	M5x0,8 0168 13 19	7	17	7	0,017
G1/4	G1/8 0168 13 10	7	17	7	0,011
	0168 17 10	9	19	6	0,019
G3/8	G1/4 0168 17 13	9	19	6	0,012
	0168 21 10	11	24	10	0,052
G1/2	G1/4 0168 21 13	11	24	10	0,042
	0168 21 17	11	24	10	0,030
	0168 27 13	11	32	12	0,098
G3/4	G3/8 0168 27 17	11	32	12	0,084
	0168 27 21	11	32	12	0,063

Junta imperdible

0163 Reducción desigual, rosca macho BSPT / hembra BSPP

Latón



C1	C2	F	L	Kg
R1/4	G1/8 0163 13 10	14	16	0,009
	G1/8 0163 17 10	17	16,5	0,020
R3/8	G1/4 0163 17 13	17	16,5	0,012
	G1/8 0163 21 10	22	21	0,048
R1/2	G1/4 0163 21 13	22	21	0,038
	G3/8 0163 21 17	22	21	0,025
	G1/4 0163 27 13	27	24	0,085
R3/4	G3/8 0163 27 17	27	24	0,069
	G1/2 0163 27 21	27	24	0,046
R1	G3/4 0163 34 27	36	27	0,085

Adaptadores de latón

209P Reducción, rosca macho / hembra NPTF

Latón



C	C1		F	L	Kg
NPTF1/4	NPTF1/8	209P-4-2	9/16	19	0,012
NPTF1/8	NPTF1/8	209P-6-2	11/16	18	0,024
NPTF3/8	NPTF1/4	209P-6-4	11/16	19	0,179
	NPTF1/8	209P-8-2	7/8	25	0,059
NPTF1/2	NPTF1/4	209P-8-4	7/8	26	0,048
	NPTF3/8	209P-8-6	7/8	26	0,033
	NPTF1/4	209P-12-4	1.1/8	25	0,093
NPTF3/4	NPTF3/8	209P-12-6	1.1/8	26	0,080
	NPTF1/2	209P-12-8	1.1/8	26	0,057

* Dimensiones de F a pulgadas

222P Reducción, rosca hembra / macho NPTF

Latón



C	C1		F	L	Kg
NPTF1/8	NPTF1/4	222P-4-2	3/4	27	0,031
NPTF1/4	NPTF3/8	222P-6-4	7/8	32	0,046
NPTF3/8	NPTF1/2	222P-8-6	11/16	37	0,082

* Dimensiones de F a pulgadas

0121 Unión igual y desigual, rosca macho BSPT

Latón



C1	C2		F	L	Kg
R1/8	R1/8	0121 10 10	11	19	0,009
R1/4	R1/8	0121 13 10	14	23,5	0,017
	R1/4	0121 13 13	14	27	0,020
R3/8	R1/8	0121 17 10	17	24	0,021
	R1/4	0121 17 13	17	27,5	0,026
R1/2	R3/8	0121 17 17	17	28	0,026
	R1/8	0121 21 10	22	28,5	0,041
	R1/4	0121 21 13	22	32	0,045
R3/4	R3/8	0121 21 17	22	32,5	0,045
	R1/2	0121 21 21	22	36	0,052
	R1/4	0121 27 13	27	35	0,078
R1	R3/8	0121 27 17	27	35,5	0,077
	R1/2	0121 27 21	27	39	0,084
	R3/4	0121 27 27	27	40	0,090
R1 1/4	R3/8	0121 34 17	36	38,5	0,127
	R1/2	0121 34 21	36	42	0,135
	R3/4	0121 34 27	36	43	0,144
R1 1/2	R1	0121 34 34	36	46	0,152
	R1/2	0121 42 21	46	46,5	0,219
	R3/4	0121 42 27	46	47,5	0,229
R2	R1	0121 42 34	46	50,5	0,234
	R1 1/4	0121 42 42	46	53	0,230

0169 Ampliador, rosca macho BSPP / hembra BSPP

Latón, Polímero técnico



C1	C2		E1	E2	F	L	Kg
G1/8	G1/4	0169 10 13	5	11,0	17	16	0,019
G3/8	G3/8	0169 10 17	5	14,0	22	19,5	0,038
	G3/8	0169 13 17	7	14,0	22	19,5	0,041
G1/4	G1/2	0169 13 21	7	14,5	27	20,5	0,060
	G1/2	0169 17 21	8	14,5	27	20,5	0,062
G3/8	G3/4	0169 17 27	8	15,5	32	22	0,082
	G1/2	0169 21 27	9,5	15,5	32	22,5	0,087

Junta impermeable

FG43 Ampliador, rosca hembra BSPP / macho BSPT

Latón



C	C1		E	F	L	Kg
R1/8	G1/4	1/4X1/8FG43B	11	17	21,5	0,019
R1/8	G3/8	3/8X1/8FG43B	12	22	25	0,035
R1/4	G3/8	3/8X1/4FG43B	12	22	28	0,040
R1/2	G3/4	3/4X1/2FG43B	16	32	39	0,107

FF44 Unión igual, rosca macho BSPP

Latón



C		E	F	L	Kg
G1/8	1/8FF44B	6	14	19	0,018
G1/4	1/4FF44B	7	17	22	0,022
G3/8	3/8FF44B	8	22	24	0,040
G1/2	1/2FF44B	10	27	31	0,077

Racores entregados con dos juntas de cobre

Adaptadores de latón

0121 Unión igual, rosca macho NPT / macho BSPT

Latón



C1	C2		F	L	Kg
NPT1/8	R1/8	0121 11 10	11	19	0,009
NPT1/4	R1/4	0121 14 13	14	27	0,021
NPT3/8	R3/8	0121 18 17	17	28	0,026
NPT1/2	R1/2	0121 22 21	22	36	0,052
NPT3/4	R3/4	0121 28 27	27	40	0,089

216P Unión igual, rosca macho NPTF

Latón



C		F	L	Kg
NPTF1/8	216P-2	7/16	25	0,011
NPTF1/4	216P-4	9/16	35	0,025
NPTF3/8	216P-6	11/16	36	0,035
NPTF1/2	216P-8	7/8	46	0,065

* Dimensiones de F a pulgadas

0929 Unión doble, 3 piezas, rosca macho BSPT

Latón

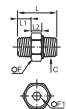

C		F	F1	L	L1	L2	Kg
R1/8	0929 00 10	15	5	27	9	8,5	0,017
R1/4	0929 00 13	19	6	33,5	11,5	9,5	0,035
R3/8	0929 00 17	22	8	36,5	13	10	0,055
R1/2	0929 00 21	27	12	45	15,5	12	0,088

Gracias a su diseño, de tres piezas, permite simplemente introduciendo y roscando la tuerca, conectar dos elementos roscados, evitando así tener que girar los componentes a roscar, optimizando por tanto el tiempo de instalación

Presión de servicio máx: 50 bar. Temperatura de utilización: -10° a + 80°C

0929..1 Unión doble, 3 piezas, rosca macho BSPT

Latón, NBR

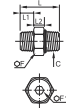

C		F	F1	L	L1	L2	Kg
R1/8	0929 01 10	15	5	27	7,5	8,5	0,017
R1/4	0929 01 13	19	6	33,5	11	9,5	0,035
R3/8	0929 01 17	22	8	36,5	11,5	10	0,055
R1/2	0929 01 21	27	12	45	14	12	0,088
R3/4	0929 01 27	36	14	52,5	16,5	17	0,199
R1	0929 01 34	46	19	63,5	19	20	0,369

Gracias a su diseño, de tres piezas, permite simplemente introduciendo y roscando la tuerca, conectar dos elementos roscados, evitando así tener que girar los componentes a roscar, optimizando por tanto el tiempo de instalación

Presión de servicio máx: 50 bar. Temperatura de utilización: -10° a + 80°C

0123 Espiga acanalada para tubo de caucho, rosca macho BSPT

Latón

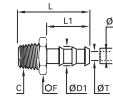



ØD	ØD1	C		F	L	L1	ØT	Kg
4	6	R1/8	0123 04 10	10	34	22,5	3,3	0,008
6	8	R1/8	0123 06 10	10	34	22,5	5	0,009
	9	R1/8	0123 07 10	10	34	22,5	5	0,009
7	9	R1/4	0123 07 13	14	38,5	22,5	6	0,018
	9	R3/8	0123 07 17	17	39	22,5	6	0,024
	12,2	R1/8	0123 10 10	13	34	22,5	5	0,014
10	12,2	R1/4	0123 10 13	14	38,5	22,5	7	0,020
	12,2	R3/8	0123 10 17	17	39	22,5	9,5	0,023
12	14	R3/8	0123 12 17	17	46	29,5	11	0,026
	15	R1/4	0123 13 13	17	45,5	29,5	7	0,027
13	15	R3/8	0123 13 17	17	46	29,5	11	0,026
	15	R1/2	0123 13 21	22	50,5	29,5	12	0,045
	18,5	R3/8	0123 16 17	19	54,5	38	11	0,039
16	18,5	R1/2	0123 16 21	22	59	38	14	0,053
	18,5	R3/4	0123 16 27	27	62	38	15	0,084
	21,5	R3/8	0123 19 17	22	54,5	38	11	0,047
19	21,5	R1/2	0123 19 21	22	59	38	14	0,057
	21,5	R3/4	0123 19 27	27	62	38	18	0,083
	26,7	R3/4	0123 25 27	27	62	38	18	0,078
25	27	R1	0123 25 34	36	65	38	24	0,124
32	34,5	R1	0123 32 34	36	70	43	24	0,144

Adaptadores de latón

0136 Espiga acanalada para tubo poliamida, rosca macho BSPT

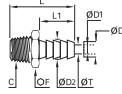
Latón



ØD	ØD1	ØD2	C		F	L	L1	ØT	Kg
6	4	4.3	R1/8	0136 06 10	10	26,5	15	2	0,006
	4	4.3	R1/4	0136 06 13	14	31	15	2	0,015
	4	4.3	R3/8	0136 06 17	17	31,5	15	2	0,020
8	6	6.4	R1/8	0136 08 10	10	26,5	15	4	0,007
	6	6.4	R1/4	0136 08 13	14	31	15	4	0,015
	6	6.4	R3/8	0136 08 17	17	31,5	15	4	0,020
10	8	8.4	R1/4	0136 10 13	14	31	15	6	0,016
	8	8.4	R3/8	0136 10 17	17	31,5	15	6	0,020
	8	8.4	R1/2	0136 10 21	22	36	15	6	0,039
12	10	10.7	R1/4	0136 12 13	14	36	20	7	0,018
	10	10.7	R3/8	0136 12 17	17	36,5	20	8	0,022
	10	10.7	R1/2	0136 12 21	22	41	20	8	0,040
14	12	12.7	R1/4	0136 14 13	14	36	20	7	0,019
	12	12.7	R3/8	0136 14 17	17	36,5	20	10	0,023
	12	12.7	R1/2	0136 14 21	22	41	20	10	0,041
16	12	12.7	R3/4	0136 14 27	27	44	20	10	0,072
	13	13.7	R3/8	0136 16 17	17	36,5	20	11	0,023
	13	13.7	R1/2	0136 16 21	22	41	20	11	0,040
	13	13.7	R3/4	0136 16 27	27	44	20	11	0,071

Adaptadores de acero inoxidable

1844 Codo igual, rosca macho BSPT / rosca hembra BSPP

Acero inox 316L

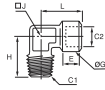

C1	C2	E	G	H	J	L	Kg
R1/8	G1/8	1844 10 10	7,5	15	20,5	10	22,5 0,022
R1/4	G1/4	1844 13 13	12	18,5	27,5	12	26,5 0,045
R3/8	G3/8	1844 17 17	12	23,5	28	14	30 0,070
R1/2	G1/2	1844 21 21	15	28	38	18	38 0,120
R3/4	G3/4	1844 27 27	16,5	33	41	22	44,5 0,160
R1	G1	1844 34 34	19	40	48	32	50 0,311

1817 Pasatabiques igual, rosca hembra BSPP

Acero inox 316L

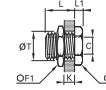

C	F	F1	K max	L	L1	ØT min	Kg
G1/8	1817 00 10	19	22	9,0	14	4	16,5 0,031
G1/4	1817 00 13	24	27	15,0	21	4	20,5 0,053
G3/8	1817 00 17	30	32	14,0	21	5	26,5 0,089
G1/2	1817 00 21	32	36	20,0	27	6	28,5 0,108
G3/4	1817 00 27	41	41	22,5	30	6	34,5 0,152
G1	1817 00 34	46	50	24,5	34	8	42,5 0,253

1843 Codo igual, rosca hembra BSPP y métrica

Acero inox 316L

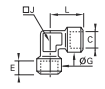

C	E	G	J	L	Kg
G1/8	1843 10 10	7,5	17,5	12	22,5 0,041
G1/4	1843 13 13	11	18,5	15	26,5 0,053
G3/8	1843 17 17	11,5	23,5	18	29 0,075
G1/2	1843 21 21	15	28	23	38 0,158
G3/4	1843 27 27	16,5	33	22	43,5 0,209
G1	1843 34 34	19	40	32	52 0,465

1871 Pasatabiques igual, rosca hembra NPT

Acero inox 316L

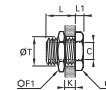

C	F	F1	K max	L	L1	ØT min	Kg
NPT1/8	1871 00 11	19	22	9,0	14	5	16,5 0,031
NPT1/4	1871 00 14	24	22	9,0	14	5	20,5 0,060
NPT3/8	1871 00 18	30	32	18,0	23	5	26,5 0,096
NPT1/2	1871 00 22	32	36	22,0	29	6	28,5 0,119

1845 Te igual, rosca hembra BSPP

Acero inox 316L

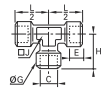

C	E	G	H	J	L/2	Kg
G1/8	1845 10 10	7,5	17,5	22,5	12	22,5 0,057
G1/4	1845 13 13	11	18,5	26,5	15	26,5 0,074
G3/8	1845 17 17	11,5	23,5	29	18	29 0,103
G1/2	1845 21 21	15	28	38	23	38 0,217
G3/4	1845 27 27	16,5	33	43,5	22	43,5 0,301
G1	1845 34 34	19	40	50	32	50 0,447

1855 Manguito hexagonal, rosca hembra BSPP

Acero inox 316L



C	F	L	Kg
G1/8	1855 10 10	14	17 0,013
G1/4	1855 13 13	17	24 0,024
G3/8	1855 17 17	22	25 0,042
G1/2	1855 21 21	27	32 0,077
G3/4	1855 27 27	14	35 0,102
G1	1855 34 34	41	40 0,202

1870 Manguito hexagonal, rosca hembra NPT

Acero inox 316L



C	F	L	Kg
NPT1/8	1870 11 11	14	19 0,015
NPT1/4	1870 14 14	17	28 0,029
NPT3/8	1870 18 18	22	28 0,050
NPT1/2	1870 22 22	27	35 0,092

Adaptadores de acero inoxidable

1862 Manguito hexagonal reductor, rosca hembra BSPP

Acero inox 316L



C1	C2		F	L	Kg
G1/4	G1/8	1862 13 10	17	20,5	0,024
	G1/8	1862 17 10	22	21	0,043
G3/8	G1/4	1862 17 13	22	24,5	0,048
	G1/4	1862 21 13	27	28,5	0,086
G1/2	G3/8	1862 21 17	27	29	0,081
G3/4	G1/2	1862 27 21	32	39,5	0,148
G1	G3/4	1862 34 27	41	45	0,282

1863 Reducción, rosca macho BSPT / hembra BSPP

Acero inox 316L



C1	C2		F	L	Kg
R1/4	G1/8	1863 13 10	14	16	0,008
	G1/8	1863 17 10	17	16,5	0,019
R3/8	G1/4	1863 17 13	17	16,5	0,011
	G1/4	1863 21 13	22	21	0,035
R1/2	G3/8	1863 21 17	22	21	0,023
R3/4	G1/2	1863 27 21	27	25,5	0,045
R1	G3/4	1863 34 27	36	28,5	0,084

1864 Adaptador, rosca macho NPT / hembra BSPP

Acero inox 316L



C1	C2		E	F	L	Kg
NPT1/8	G1/8	1864 11 10	7,5	14	21,5	0,015
NPT1/4	G1/4	1864 14 13	11	17	30	0,028
NPT3/8	G3/8	1864 18 17	11,5	22	31	0,044
NPT1/2	G1/2	1864 22 21	15	27	39,5	0,081

1872 Reducción, rosca macho NPT / hembra NPT

Acero inox 316L



C1	C2		F	L	Kg
NPT1/4	NPT1/8	1872 14 11	14	16	0,010
	NPT1/8	1872 18 11	19	16,5	0,023
NPT3/8	NPT1/4	1872 18 14	19	16,5	0,016
	NPT1/4	1872 22 14	22	21	0,039
NPT1/2	NPT3/8	1872 22 18	22	21	0,027

1867 Adaptador, rosca macho BSPT / hembra NPT

Acero inox 316L



C1	C2		E	F	L	Kg
R1/8	NPT1/8	1867 10 11	8	14	21	0,015
R1/4	NPT1/4	1867 13 14	11,5	17	28,5	0,028
R3/8	NPT3/8	1867 17 18	12	22	29,5	0,045
R1/2	NPT1/2	1867 21 22	15,5	27	37,5	0,082

1861 Ampliador, rosca macho BSPT / hembra BSPP

Acero inox 316L



C1	C2		E	F	L	Kg
R1/8	G1/4	1861 10 13	11	17	24	0,022
	G3/8	1861 10 17	11,5	22	25	0,038
R1/4	G3/8	1861 13 17	11,5	22	28,5	0,042
	G1/2	1861 13 21	15	27	32,5	0,069
R3/8	G1/2	1861 17 21	15	27	33	0,069
R1/2	G3/4	1861 21 27	16,5	32	38	0,093
R3/4	G1	1861 27 34	19	41	43,5	0,181

Adaptadores de acero inoxidable

1873 Ampliador, rosca macho NPT / hembra NPT

Acero inox 316L



C1	C2		E	F	L	Kg
NPT1/8	NPT1/4	1873 11 14	14	17	25	0,024
NPT1/8	NPT3/8	1873 11 18	14	22	25	0,039
NPT1/4	NPT3/8	1873 14 18	14	22	28,5	0,043
NPT1/4	NPT1/2	1873 14 22	17,5	27	31	0,066
NPT3/8	NPT1/2	1873 18 22	17,5	27	31,5	0,066

1821 Unión igual y desigual, rosca macho BSPT

Acero inox 316L



C1	C2		F	L	Kg
R1/8	R1/8	1821 10 10	12	19	0,009
R1/4	R1/8	1821 13 10	14	23,5	0,015
	R1/4	1821 13 13	14	27	0,019
R3/8	R1/4	1821 17 13	17	27,5	0,023
	R3/8	1821 17 17	17	28	0,024
R1/2	R3/8	1821 21 17	22	32,5	0,042
	R1/2	1821 21 21	22	36	0,049
R3/4	R1/2	1821 27 21	27	41	0,079
	R3/4	1821 27 27	27	42	0,088
R1	R3/4	1821 34 27	36	46	0,141
	R1	1821 34 34	36	48	0,147

1821 Unión igual, rosca macho NPT

Acero inox 316L



C		F	L	Kg
NPT1/8	1821 11 11	12	23	0,011
NPT1/4	1821 14 14	14	32	0,023
NPT3/8	1821 18 18	19	33	0,031
NPT1/2	1821 22 22	22	42	0,056
NPT3/4	1821 28 28	27	40	0,083

1823 Espiga acanalada para tubo de caucho, rosca macho BSPT

Acero inox 316L

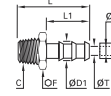

ØD	ØD1	C		F	L	L1	ØT	Kg
7	9	R1/8	1823 07 10	10	34	22,5	5	0,009
	9	R1/4	1823 07 13	14	38,5	22,5	6	0,017
10	12,2	R1/4	1823 10 13	14	38,5	22,5	7	0,018
	12,2	R3/8	1823 10 17	17	39	22,5	9,5	0,021
13	15	R3/8	1823 13 17	17	46	29,5	11	0,025
16	18,5	R1/2	1823 16 21	22	59	38	14	0,048

1823 Espiga acanalada para tubo de caucho, rosca macho NPT

Acero inox 316L

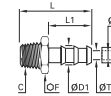

ØD	ØD1	C		F	L	L1	ØT	Kg
1/4	8,3	NPT1/8	1823 56 11	12	34	22,5	5,3	0,010
	8,3	NPT1/4	1823 56 14	14	38,5	22,5	5,3	0,016
3/8	11,7	NPT1/4	1823 60 14	14	38,5	22,5	8,5	0,018
	11,7	NPT3/8	1823 60 18	19	39	22,5	8,5	0,026

Regletas de distribución de latón y aluminio anodizado

0135 Regleta de distribución, rosca hembra BSPP

Latón

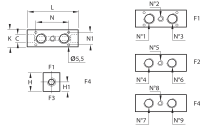

C		H	H1	K	L	N	Kg
G1/4	0135 06 13	30	13	25	70	37	0,335
	0135 09 13	30	13	25	87	54	0,409
G1/2	0135 06 21	40	16	35	86	45	0,714
	0135 09 21	40	16	35	109	68	0,900
G3/4	0135 10 27	45	21	40	122	78	1,232

Estas regletas permiten la distribución en múltiples direcciones.

Acoplando en las salidas, racores en te, cruces o «banjos», se pueden aumentar las posibilidades de distribución.

3311 Regleta de distribución, con orificios roscados hembra BSPP y métrica

Aluminio tratado

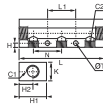

C1	C2		Núm. de salidas	H	H1	H2	K	L	L1	N	ØT	Kg
G1/8	M5x0,8	3311 19 10 07	7	3,5	20	8,5	15	95	80	11	4,4	0,057
		3311 10 13 02	2	4,5	30	15	20	61	50	30	5	0,075
		3311 10 13 03	3	4,5	30	15	20	91	30	30	5	0,112
G1/4	G1/8	3311 10 13 04	4	4,5	30	15	20	121	60	30	5	0,165
		3311 10 13 05	5	4,5	30	15	20	151	90	30	5	0,209
		3311 10 13 06	6	4,5	30	15	20	181	120	30	5	0,244
G1/4		3311 13 17 02	2	5,5	30	11	20	74	61	36	6,5	0,076
		3311 13 17 03	3	6	30	11	20	110	36	36	6,5	0,121
		3311 13 17 04	4	6	30	11	20	146	72	36	6,5	0,147
G3/8	G1/4	3311 13 17 05	5	6	30	11	20	182	108	36	6,5	0,212
		3311 13 17 06	6	6	30	11	20	218	144	36	6,5	0,220

3312 Regleta de distribución en cruz, rosca hembra BSPP y métrica

Aluminio tratado

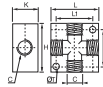

C		H	K	L	L1	N	ØT	Kg
M5x0,8	3312 00 19	20	10	20	12	12	4,5	0,008
G1/8	3312 00 10	30	16	30	23	22	4,5	0,028
G1/4	3312 00 13	40	20	40	30	27	5,5	0,061
G3/8	3312 00 17	50	25	50	38	39	6,5	0,118
G1/2	3312 00 21	50	25	50	38	39	6,5	0,101

3313 Regleta de distribución doble, con orificios roscados hembra BSPP

Aluminio tratado

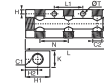

C1	C2		Núm. de salidas	H	H1	H2	K	L	L1	N	ØT	Kg
G1/4	G1/8	3313 10 13 02	2x2	4,5	30	15	20	61	50	30	5	0,075
		3313 10 13 03	2x3	4,5	30	15	20	91	30	30	5	0,115
		3313 10 13 04	2x4	4,5	30	15	20	121	60	30	5	0,151
G1/4	G1/8	3313 10 13 05	2x5	4,5	30	15	20	151	90	30	5	0,182
		3313 13 17 02	2x2	6	40	20	20	74	61	36	6,5	0,109
		3313 13 17 03	2x3	6	40	20	20	110	36	36	6,5	0,179
G3/8	G1/4	3313 13 17 04	2x4	6	40	20	20	146	72	36	6,5	0,238
		3313 13 17 05	2x5	6	40	20	20	182	108	36	6,5	0,286
		3313 13 21 03	2x3	6	40	20	28	116	36	36	6,5	0,230
G1/2	G1/4	3313 13 21 04	2x4	6	40	20	28	152	72	36	6,5	0,298
		3313 13 21 05	2x5	6	40	20	28	188	108	36	6,5	0,377

3301 Regleta de distribución modular

Aluminio tratado, NBR

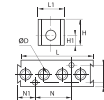

ØD		Núm. de salidas	H	H1	H2	H3	L	L1	N	N1	Kg
4	3301 04 00	8	25	10	4,5	16	73,5	25	35	17	0,108
6	3301 06 00	4	25	10	4,5	16	73,5	25	35	17	0,109

Fijación por tornillo M3 x 20

3303 Regleta de distribución modular

Aluminio tratado



	H	H1	L	Kg
3303 00 01	9,5	3,5	25	0,014

Adaptadores de latón niquelado



0222 Tapón hexagonal, rosca macho BSPP y métrica

Latón niquelado, NBR



C	E	F	F1	H	Kg
M5x0,8 0222 19 00	3,5	8	2,5	7	0,002
M7x1 0222 55 00	5	10	3	8,5	0,003
G1/8 0222 10 00	5	13	5	8,5	0,006
G1/4 0222 13 00	5,5	16	6	9,5	0,010
G3/8 0222 17 00	5,5	20	8	10,5	0,019
G1/2 0222 21 00	7,5	24	10	12	0,031

Con junta de estanqueidad

0936 Tapon hexagonal, rosca macho y hembra BSPP y métrica

Latón niquelado

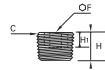

C	F	H	Kg
R1/8 0936 00 10	5	8	0,003
R1/4 0936 00 13	6	10	0,007
R3/8 0936 00 17	8	11	0,013
R1/2 0936 00 21	10	13	0,026

0919 Tapón hexagonal interior, rosca macho BSPP y métrica

Latón niquelado

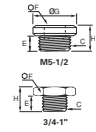

C	E	F	G	H	Kg
M5x0,8 0919 00 19	4	2,5	8	6,5	0,001
G1/8 0919 00 10	6	5	15	9,5	0,007
G1/4 0919 00 13	8	6	18	11,5	0,013
G3/8 0919 00 17	9	8	21	13	0,021
G1/2 0919 00 21	10	10	25	14,5	0,035
G3/4 0919 00 27	11	14	31	15,5	0,049
G1 0919 00 34	13	17	38	17,5	0,072

0919..1 Tapón hexagonal interior, con sello rosca macho BSPP y métrica

Latón niquelado

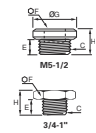

C	E	F	G	H	Kg
G1/8 0919 01 10	6,5	5	14	9,5	0,005
G1/4 0919 01 13	8	6	17	11,5	0,011
G3/8 0919 01 17	9	8	20	12,5	0,018
M5x0,8 0919 01 19	4,5	2,5	8	7,2	0,001
G1/2 0919 01 21	10	10	26	14	0,032

Tapón roscado de latón

0205 Tapón hexagonal interior, rosca macho BSPT

Latón

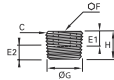

C	E1	E2 max	E2 min	F	G	H	Kg
R1/16 0205 07 00	4	3,2	3,9	3	7,2	8	0,002
R1/8 0205 10 00	6	4,9	3,1	5	9,7	8	0,003
R1/4 0205 13 00	8	7,3	4,7	6	13,2	10	0,007
R3/8 0205 17 00	8	7,7	5,1	8	16,7	11	0,013
R1/2 0205 21 00	8	10	6,4	10	21	13	0,026
R3/4 0205 27 00	11	11,3	7,7	14	26,5	17	0,053
R1 0205 34 00	13	12,7	8,1	17	33,2	19	0,094
R1 1/4 0205 42 00	14	15	10,4	22	42	22	0,178
R1 1/2 0205 49 00	14	15	10,4	24	47,8	22	0,243
R2 0205 48 00	16	18,2	13,6	30	59,6	25	0,435

Para los tapones BSPT de 1/2" a 1 1/2" inclusive:
Características generales, según norma DIN 906
Rosca, norma EN 10226-1

0205 Tapón hexagonal interior, rosca macho NPT

Latón

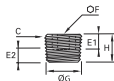

C	E1	E2 max	E2 min	F	G	H	Kg
NPT1/8 0205 11 00	6	5,0	3,2	5	10,2	8	0,004
NPT1/4 0205 14 00	8	7,2	4,4	6	13,6	10	0,008
NPT3/8 0205 18 00	8	7,5	4,7	8	17	11	0,014
NPT1/2 0205 22 00	8	9,9	6,3	10	21,2	13	0,026
NPT3/4 0205 28 00	11	10,4	6,8	14	26,6	17	0,053
NPT1 0205 35 00	13	12,4	8,0	17	33,2	19	0,091

219P Tapón hexagonal, rosca macho NPTF

Latón



C	F	H	Kg
NPTF1/8 219P-2	3/16	8	0,004

* Dimensiones de F a pulgadas

0209 Tapon cabezal cubico, rosca macho BSPT

Latón

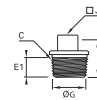

C	E1	E2 max	E2 min	G	H	J	Kg
R1/8 0209 10 00	6	4,9	3,1	9,7	16	6	0,009
R1/4 0209 13 00	8	7,3	4,7	13,2	18	8	0,015
R3/8 0209 17 00	10	7,7	5,1	16,7	20	10	0,025
R1/2 0209 21 00	11	10,0	6,4	21	22	13	0,047
R3/4 0209 27 00	15	11,3	7,7	26,4	28	17	0,097

Características generales, según norma DIN 906
Rosca, norma EN 10226-1

0200 Tapon hexagonal, rosca macho BSPP y métrica

Latón

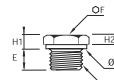

C	E	F	G	H1	H2	Kg
M6x1 0200 52 00	6	10	10	4	3,5	0,004
M8x1,25 0200 57 00	7	13	13	4	3,5	0,007
M10x1 0200 60 00	8	14	14	5	4,5	0,011
M12x1 0200 65 00	9	17	17	5	4,5	0,017
M12x1,25 0200 66 00	9	17	17	5	4,5	0,018
G1/8 0200 10 00	7	14	13,7	5,5	4	0,011
G1/4 0200 13 00	8,5	17	16,7	5,5	4	0,019

0201 Tapón hexagonal con junta impermeable, rosca macho BSPP y métrica

Latón



C	E	F	G	H1	H2	Kg
M16x1,5 0201 75 00	10	17	22	6,5	5	0,025
M18x1,5 0201 78 00	10	17	24	7	5	0,026
M20x1,5 0201 80 00	10	17	26	7,5	5	0,031
M22x1,5 0201 82 00	10	22	30	7,5	5	0,044
M24x1,5 0201 83 00	10	22	32	7,5	5	0,048
M24x2 0201 92 00	10	22	32	7,5	5	0,046
M30x2 0201 88 00	11	27	38	8,5	6	0,075
G3/8 0201 17 00	10	17	21,7	6,5	4,5	0,024
G1/2 0201 21 00	10	22	26,7	7,5	5	0,040
G3/4 0201 27 00	11	22	31,7	8,5	6	0,058
G1 0201 34 00	11	27	39,7	8,5	6	0,087
G1 1/4 0201 42 00	12	30	49,7	10	7	0,141

Tapón roscado de latón

HP3 Tapón hexagonal, rosca macho BSPT

Latón



C		F	H	Kg
R1/8	1/8HP3B	10	12	0,007
R1/4	1/4HP3B	14	16	0,018
R3/8	3/8HP3B	17	17	0,029
R1/2	1/2HP3B	22	21	0,060
R3/4	3/4HP3B	27	24	0,109
R1	1HP3B	36	27	0,196

218P Tapón hexagonal, rosca macho NPTF, serie pesada

Latón



C		F	H	Kg
NPTF1/8	218P-2	7/16	14	0,008
NPTF1/4	218P-4	9/16	19	0,016
NPTF3/8	218P-6	11/16	20	0,033
NPTF1/2	218P-8	7/8	25	0,044

* Dimensiones de F a pulgadas

0202 Tapón hexagonal interior con collarín, rosca macho métrica

Latón

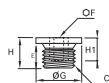

C		E	F	G	H	H1	Kg
M12x1	0202 65 00	9	6	17	11	8	0,009
M12x1,25	0202 66 00	9	6	17	11	8	0,009
M14x1,5	0202 71 00	10	6	19	13	10	0,015
M16x1,5	0202 75 00	10	8	22	13	10	0,019
M18x1,5	0202 78 00	10	10	24	13	10	0,023
M20x1,5	0202 80 00	10	12	26	13	10	0,025
M22x1,5	0202 82 00	10	12	30	13	10	0,034
M27x2	0202 86 00	11	17	35	15	11	0,052
M30x2	0202 88 00	11	19	38	15	11	0,062

Rosca BSPP métrica ISO, normas NFE 03-054

Tapones roscados de acero

0206 Tapón hexagonal interior, rosca macho BSPT

Acero

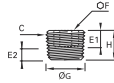

C	E1	E2 max	E2 min	F	G	H	Kg
R1/8 0206 10 00	4	3,9	2,1	5	9,7	8	0,003
R1/4 0206 13 00	5	5,8	3,2	7	13,2	10	0,007
R3/8 0206 17 00	5	5,8	3,2	8	16,7	10	0,012
R1/2 0206 21 00	5	6,8	3,2	10	21	10	0,022
R3/4 0206 27 00	6	7,8	4,2	12	26,4	12	0,048
R1 0206 34 00	6	9,3	4,7	17	33,2	12	0,085
R1 1/4 0206 42 00	11,5	9,8	5,2	22	41,9	18	0,166
R1 1/2 0206 49 00	11,5	9,8	5,2	24	47,8	20	0,222

Tapones BSP cónicos de 1/2" a 1 1/2" inclusive :
Características generales según norma DIN 906
Rosca, norma EN 10226-1

0206 Tapón hexagonal interior, rosca macho NPT

Acero

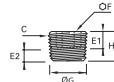

C	E1	E2 max	E2 min	F	G	H	Kg
NPT1/16 0206 08 00	6	6,4	3,8	4	7,8	7	0,002
NPT1/8 0206 11 00	6	5,0	3,2	5	10,2	8	0,003
NPT1/4 0206 14 00	8	7,2	4,4	6	13,6	10	0,007
NPT3/8 0206 18 00	8	7,5	4,7	8	17	11	0,012
NPT1/2 0206 22 00	8	9,9	6,3	10	21,2	13	0,023
NPT3/4 0206 28 00	11	10,4	6,8	14	26,6	17	0,048
NPT1 0206 35 00	13	12,4	8,0	17	33,2	19	0,082

0210 Tapón hexagonal, rosca macho BSPP y métrica

Acero

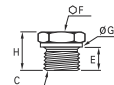

C	E	F	G	H	Kg
M8x1,25 0210 57 00	8	14	12	15	0,011
G1/8 0210 10 00	8	14	14	15	0,013
G1/4 0210 13 00	12	19	18	21	0,031
G3/8 0210 17 00	12	22	22	21	0,046
G1/2 0210 21 00	14	27	26	24	0,078
G3/4 0210 27 00	16	32	32	27	0,133
G1 0210 34 00	18	41	39	33	0,270

Perfil de junta según norma DIN 3852 : forma D/E
Rosca BSPP, norma ISO 228-1
Rosca métrica ISO, norma NFE 03-054

0216 Tapón hexagonal, rosca macho BSPT

Acero



C	F	H	Kg
R1/8 0216 10 00	13	16	0,012
R1/4 0216 13 00	17	19	0,023
R3/8 0216 17 00	19	21	0,038
R1/2 0216 21 00	22	23	0,060

Rosca BSPT, norma EN 10226-1

0216 Tapón hexagonal, rosca macho BSPT

Acero



C	F	H	Kg
NPT1/8 0216 11 00	13	16	0,012
NPT1/4 0216 14 00	17	19	0,023
NPT1/2 0216 22 00	22	23	0,060

Tapones de acero inoxidable

0285 Tapón hexagonal interior, macho BSPT

Acero inox 316L

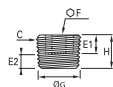

C		E1	E2 max	E2 min	F	G	H	Kg
R1/8	0285 10 00	4	3,9	2,1	5	9,7	8	0,003
R1/4	0285 13 00	5	5,8	3,2	7	13,1	10	0,007
R3/8	0285 17 00	5	5,8	3,2	8	16,7	10	0,012
R1/2	0285 21 00	5	6,8	3,2	10	21	10	0,024
R3/4	0285 27 00	6	7,8	4,2	12	26,4	12	0,051
R1	0285 34 00	6	9,3	4,7	17	33,2	12	0,089

según norma DIN 906 y EN 10226-1

0285 Tapón hexagonal interior, rosca macho NPT

Acero inox 316L

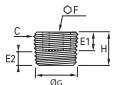

C		E1	E2 max	E2 min	F	G	H	Kg
NPT1/8	0285 11 00	6	5,0	3,2	5	10,2	8	0,003
NPT1/4	0285 14 00	8	7,2	4,4	6	13,6	10	0,007
NPT3/8	0285 18 00	8	7,5	4,7	8	17	11	0,013
NPT1/2	0285 22 00	8	9,9	6,3	10	21	13	0,025

según norma ANSI B1.20.1

Accesorios de estanqueidad

0137 Anillo bi-materia

Acero galvanizado con junta NBR



C		G1	G2	K	Kg
M12	0137 12 00	12,7	19,0	1,5	0,001
M14	0137 14 00	14,7	21,0	1,5	0,002
M16	0137 16 00	16,7	23,0	1,5	0,002
M18	0137 18 00	18,7	27,0	2	0,004
M20	0137 20 00	20,7	29,0	2	0,004
M22	0137 22 00	22,7	31,0	2	0,005
M24	0137 24 00	24,7	33,0	2	0,005
G1/8	0137 10 00	10,7	17,0	1,5	0,001
G1/4	0137 13 00	13,7	20,6	2,1	0,002
G3/8	0137 17 00	17,4	23,7	1,5	0,002
G1/2	0137 21 00	21,5	28,6	2,5	0,004
G3/4	0137 27 00	27,0	35,3	2	0,007
G1	0137 33 00	33,7	42,0	2	0,007
G1 1/4	0137 42 00	43,0	54,0	2,5	0,013
G1 1/2	0137 48 00	49,0	60,0	2,5	0,015

Nota: para la correcta utilización de estas juntas, la superficie de contacto debería ser igual al diámetro exterior de la junta, aumentado de 0,3 a 0,5 mm, si bien no es indispensable. El estado de la superficie de la cara que hace el apoyo no debe sobrepasar una rugosidad total de 12 μ .

0602 Junta imperdible

Polímero técnico



C		G1	G2	K	Kg
M5x0,8	0602 29 93 15	5,2	7,8	1,5	0,001
G1/8	0602 23 10 20	10,3	14,0	2	0,001
G1/4	0602 23 11 20	13,7	17,5	2	0,001
G3/8	0602 23 12 20	17,2	21,0	2	0,001
G1/2	0602 23 13 20	21,5	25,5	2,5	0,002
G3/4	0602 27 32 20	27,0	32,0	2,5	0,001
G1	0602 30 60 20	33,8	39,0	3	0,002

20 bar máximo

0139 Junta imperdible

Acero galvanizado con junta NBR



C		G	K	K1	Kg
G1/8	0139 10 00	14	1	1,7	0,001
G1/4	0139 13 00	17	1	1,7	0,001
G3/8	0139 17 00	22	1,2	2,1	0,001
G1/2	0139 21 00	26	1,6	2,5	0,002
G3/4	0139 27 00	32	1,5	2,5	0,003
G1	0139 34 00	39,6	1,7	2,6	0,003

250 bar máximo

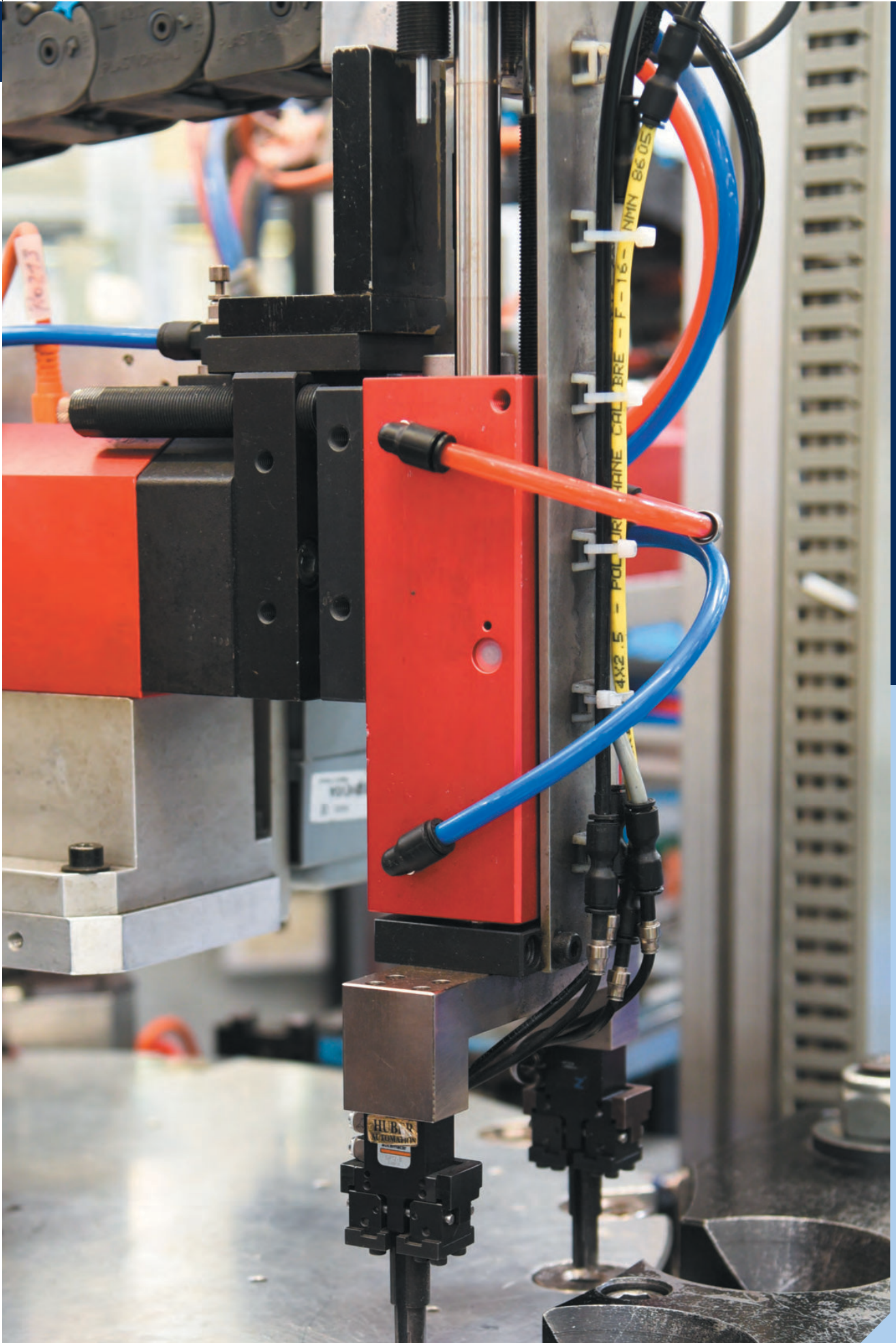

#02

ENCHUFES AUTOMÁTICOS

Latón / Acero

Acero inoxidable

Termoplástico

Caras planas

Enchufes de seguridad

Sistemas codificados

Accesorios

Enchufes para moldes

Enchufes para agua





Resumen de las especificaciones del producto

Cuáles son sus condiciones de uso?

MATERIALES DE DEL ENCHUFE

Latón/acero:

- Principalmente para aplicaciones neumáticas

Acero inoxidable: AISI 303 o 316L

- Para los medios agresivos
- Alta resistencia a la corrosión

Termoplástico: POM / PVDF

- Para todo tipo de medios, por ejemplo, fluidos químicos

MATERIALES DE LAS JUNTAS*

- NBR: -20°C hasta +100°C
- EPDM: -40°C hasta +150°C
- FKM: -15°C hasta +200°C
- FFKM: -25°C hasta +240°C

* dependiendo del medio

Qué perfil de intercambiabilidad necesitas?

Perfil

- ISO B
- ISO C
- Euro
- ARO
- REINO UNIDO
- SCANDIC
- ASIA

Cuál es su entorno de aplicación?

La presión:

Presión del sistema, picos de presión

Temperatura:

Medio, Medio Ambiente, Operación/Parada

Medio:

Aire comprimido, vacío, agua/agua de mar, otros fluidos/gases

La tasa de caudal:

Flujo de volumen, viscosidad media, conexión final

Entorno operativo:

Calidad del aire ambiente (contaminación?), riesgo de choques, áreas confinadas/dificultades de acceso, uso de productos en equipos móviles, atmósfera corrosiva

Qué conexión final necesitas?

- Conexión de la manguera
- Conexión roscada
- La conexión del tubo de plástico

Qué función y control de flujo necesita?

La dirección de cierre siempre se define por la combinación de acoplamientos y enchufes.

KF Sin obturación

- Mejor caudal/sin turbulencias
- Ideal para el uso con líquidos

KB Doble obturación

- Válvulas de cierre en el enchufe y el enchufe automático
- La presión se mantiene en ambos lados

KL Doble obturación sin goteo

- El enchufe y el enchufe automático tienen una válvula plana. Ideal para evitar que las gotas del medio se escapen

KA Simple obturación

- El enchufe es directo
- El caudal es detenido por la válvula dentro del acoplador durante la desconexión



Válvula estándar

Diseño robusto y compacto



Válvula de alto caudal

El flujo aumenta hasta un 80% en comparación con los sistemas tradicionales debido a la menor turbulencia



Válvula de caudal ultra alto

La válvula de alta gama extremadamente aerodinámica garantiza un flujo óptimo y se puede encontrar en nuestra serie de ahorro de energía

Qué medidas de seguridad necesita?

KS Simple obturación

KS Aire respirable

KD Doble obturación

- Enchufe de seguridad
- El mecanismo de bloqueo de seguridad evita la desconexión involuntaria

KE Sistema de descompresión

KP Sistema de descompresión a botón

- Enchufe de seguridad con un sistema de descompresión
- No hay desconexión involuntaria ni efecto de latigazo para evitar el riesgo de accidentes de trabajo

KA Sistemas codificados

- Enchufe de seguridad, mecánica y código de colores
- Evite las confusiones entre los medios al acoplar

Identificación del número de pieza

Acoplamientos

KA = Simple obturación
KB = Doble obturación
KF = Sin obturación
KL = Doble obturación sin goteo
KE = Sistema de decompresión
KP = Pulsador
KS = Seguridad (Simple obturación)
KD = Seguridad (Doble obturación)
KR = Seguridad (Sin obturación)

Plugs

SF = Sin obturación
SB = Doble obturación
SL = Doble obturación sin goteo
SS = Seguridad (Sin obturación)
SD = Seguridad (Doble obturación)
SR = Eliminador de retroceso

Rosca métrica

05 = M5
10 = M10 x 1
12 = M12 x 1,5
14 = M14 x 1,5
16 = M16 x 1,5
18 = M18 x 1,5

Rosca gas

10 = 1/8"
13 = 1/4"
17 = 3/8"
21 = 1/2"
26 = 3/4"
33 = 1"

Conexión de la manguera

03 = para 3 mm LW (1/8")
04 = para 4 mm LW (5/32")
06 = para 5 mm LW (1/4")
08 = para 8 mm LW (5/16")
09 = para 9 mm LW (3/8")
13 = para 13 mm LW (1/2")
19 = para 19 mm LW (3/4")
25 = para 25 mm LW (1")

Manguera plástica

04 = para 3 x 4 mm
05 = para 3 x 5 mm
36 = para 3 x 6,3 mm
06 = para 4 x 6 mm
46 = para 4 x 6,3 mm
08 = para 6 x 8 mm
10 = para 8 x 10 mm
12 = para 9 x 12 mm
16 = para 13 x 16 mm

Junta

X = sin junta
P = Perbunan NBR
V = FKM/FFPM
E = EPDM de etileno-propileno
K = FFKM

Añadiendo 2 Codificación de color para el plástico

B = Azul
G = Verde
R = Rojo
Y = Amarillo

Superficie

X = sin tratamiento de superficie
N = níquelado
C = Cromado
Z = Cincado
D = Durnicoated (chemic. zinc plated)
G = Cincado y cromado amarillo
P = Los resortes de presión hechos de PEEK (sólo para RECTUCHEM+)

21

KA

AW

13

M

P

X

X

X

Serie No

Material

M = Latón CuZn39Pb3 - 2.0401 (excepto la corredera)
B = Latón CuZn39Pb3 - 2.0401 (completamente)
S = Acero 9SMnPb28K - 1.0718
R = Acero inoxidable - AISI 303
E = Acero inoxidable - AISI 316 L
D = POM (Delrin)
F = PVDF

Añadiendo 1

S = Marcado para la versión especial
0 = RECTUKey ronda
3 = RECTUKey triángulo
6 = RECTUKey hexágono
8 = RECTUKey octágono

Conexión de la manguera

TF = Espiga acanalada
TH = Espiga acanalada 45°
TR = Espiga acanalada 90°
TP = Parker Push-Lok
PH = Parker Push-Lok 45°
PR = Parker Push-Lok 90°
TS = con espiga acanalada
TE = Instalación del panel frontal, montaje del panel espiga acanalada

Rosca macho

AW = BSP cilíndrico
AM = Rosca métrica DIN 13
AK = BSP cónico
AN = Rosca NPT ANSI B 1.20.1 cónica
AD = Rosca métrica DIN 2353 (ISO 8434-1)
AR = BSP cónico 90°

Rosca hembra

IW = BSP cilíndrico
IM = Rosca métrica DIN 13
IK = BSP cónico
IN = Rosca NPSF ANSI B 1.20.3
IT = Rosca cónica NPT ANSI B 1.20.1

Conexión del tubo de plástico

KO = con Tuerca de Manguera, sin protección de resorte
KS = Montado en un panel, sin protección de resorte
KK = con la protección de resorte



Perfiles comunes

Perfil europeo				Perfil ISO 6150C			Perfil ISO 6150B			Perfil de ARO
Serie 20	Serie 21	Serie 25-26-1625	Serie 27-1700-1727	Serie 303	Serie 18	Serie 84	Serie 23-24-1423	Serie 30	Serie 37	Serie 14-22
										

Qué serie se recomienda?

	Perfil	DN	Serie	 KF	 KA	 KB	 KL	Enchufes
Latón / Acero		1,5	Serie 02		P.200			Serie 02
		2	Mini Serie		P.202	P.203		Mini Serie
	Alemán	2,5	Serie 50		P.204			Serie 50
	EURO	2,7	Serie 20		P.206	P.208		Serie 20
		3	Serie Mini	P.211				Serie Mini
		5	Serie Standard		P.212			Serie Standard
	Británico	5	Serie 17		P.214			Serie 17
	EURO	5	Serie 21		P.216	P.219	P.222	Serie 21
	ARO	5,5	Serie 14		P.225			Serie 22
	ISO 6150 C	5,5	Serie 18		P.227			Serie 18
	Británico	5,5	Serie 19		P.229			Serie 19
	ARO	5,5	Serie 22		P.231			Serie 22
	ISO 6150 B	5,5	Serie 24		P.233			Serie 23
	ISO 6150 B	5,5	Serie 23		P.235			Serie 23
	ISO 6150 B	5,5	Serie 1400		P.237			Serie 23
	Alemán	6	Serie 52		P.239	P.239		Serie 52
	EURO	7,2	Serie 26		P.241	P.243		Serie 25/26
	Japonés	7,5	Serie 13		P.245			Serie 13
	EURO	7,8	Serie 25		P.247	P.249		Serie 25
	EURO	7,8	Serie 1600		P.251			Serie 25
	EURO	7,8	Serie 1625		P.253			Serie 25
	Escandinavo	8	Serie 33		P.255			Serie 33
	ISO 6150 B	8,5	Serie 30		P.257			Serie 30
	ARO	9	Serie 40		P.259			Serie 40
	EURO	10	Serie 27		P.260	P.261		Serie 27
	EURO	10	Serie 1700		P.263			Serie 27
	EURO	10	Serie 1727		P.265			Serie 27
	Escandinavo	10	Serie 34		P.267			Serie 34
	varios	10	Serie 41	P.269				Serie 41
	ISO 6150 B	11	Serie 37		P.271			Serie 37
Alemán	12	Serie 57		P.273	P.273		Serie 57	
Americano	15	Serie 38		P.275	P.275		Serie 38	
Americano	19	Serie 39		P.277	P.277	P.278	Serie 39	
ISO 7241-1 B	4,3-20	Serie 70			P.280		Serie 70	
Acero inoxidable	EURO	2,7	Serie 20		P.281	P.282		Serie 20
	ISO 6150 C	3	Serie 303			P.284		Serie 303
	EURO	5	Serie 21		P.286	P.288		Serie 21
	EURO	7,4	Serie 25		P.290	P.291		Serie 25
	EURO	10	Serie 27		P.293	P.294		Serie 27
	ISO 7241-1 B	4,3-20	Serie 70			P.296		Serie 70

		Perfil	DN	Serie					Enchufes
Termo-plástico			5	Serie 21		P.297	P.297		Serie 21
			7	Serie 48		P.303	P.303		Serie 48
			4,3-20	Serie 70			P.307		Serie 70
				Componentes					
Caras planas			4-9	Serie 200KL				P.309	Serie 200
			3-12	Serie 200KLEK				P.311	Serie 200KLEK
Seguridad	Estándar		5	Serie 21KS		P.313	P.314		Serie 21
			7,8	Serie 25KS		P.316	P.317		Serie 25
	Aire respirable		7,4	Serie 95KS		P.318			Serie 95
			7,4	Serie 96KS		P.320			Serie 96
	Descompresión con tecnología de botón pulsador	ISO 6150 C	5,5	Serie 18KP		P.322			Serie 18
		ISO 6150 B	5,5	Serie 24KP		P.324			Serie 23
		EURO	7,4	Serie 26KP		P.326			Serie 25
		ISO 6150 B	8	Serie 30KP		P.328			Serie 30
	Descompresión con tecnología de corredera	ISO 6150 C	8	Serie 84KP		P.330			Serie 84
		ARO	5,5	Serie 14KE		P.332			Serie 22
		ISO 6150 B	5,5	Serie 1400KE		P.334			Serie 23
		ISO 6150 B	5,5	Serie 24KE		P.336			Serie 23
		EURO	7,4	Serie 26KE		P.338			Serie 25
		EURO	7,8	Serie 1600KE		P.340			Serie 25
			10	Serie 1700KE		P.342			Serie 27
				C 9000		P.344			C 9000
Sistemas codificados			5	Serie 21		P.349	P.350		Serie 21
			7,8	Serie 25		P.352	P.354		Serie 25
Accesorios		Componentes							
Moldes		Internacional	6 / 9 / 13	Serie 86 / 87 / 88	P.358	P.360	P.360		Serie 86/87/88
		Internacional	6 / 9	Serie 86 / 87 Tecnología de cierre seguro	P.363	P.364	P.364		Serie 86/87/88
		Europeo	6 / 9 / 13	Serie 10 / 11 / 12	P.365	P.367	P.367		Serie 10/11/12
		Europeo	6 / 9	Serie 10 / 11 Tecnología de cierre seguro	P.370	P.371	P.371		Serie 10/11/12
		Europeo	6 / 9	Serie 10 / 11 Tecnología de cierre de seguridad	P.372	P.373	P.373		Serie 10/11/12
		Francés	8	Serie 608	P.375				Serie 608
		Multi-Matic	8,1	Serie 93	P.377			P.377	Serie 93
		Accesorios		Componentes					
		Mangueras							
Agua			12	Serie Midi	P.381	P.381			Serie Midi
			19	Serie Maxi	P.384				Serie Maxi

Nuestra gama de prestaciones de un vistazo

Caudal de aire

Con este diagrama de flujo, puede identificar, de un vistazo, la serie de enchufe automático adecuada para su aplicación y la presión de funcionamiento correspondiente.

Muchas de las series enumeradas a continuación también están disponibles en versión KF de paso directo.

- Caudal KA (l/min.) – sistemas de enchufe automático de simple obturación -
Particularmente adecuado para las aplicaciones neumáticas
- Caudal KB (l / min.) – sistemas de enchufe de doble obturación
- Particularmente adecuado para aplicaciones de manejo de fluidos
- Caudal KE/KP (l/min.) – sistemas de descompresión
- Particularmente adecuado para las aplicaciones neumáticas



Los detalles se refieren al caudal de aire en litros/minuto.

Datos de medición generados de acuerdo con la norma ISO 6358;
CCTOP RP50P a una presión de entrada de 6 bar, caída de presión de 0,5 bar / *caída de presión de 0,6 bar)

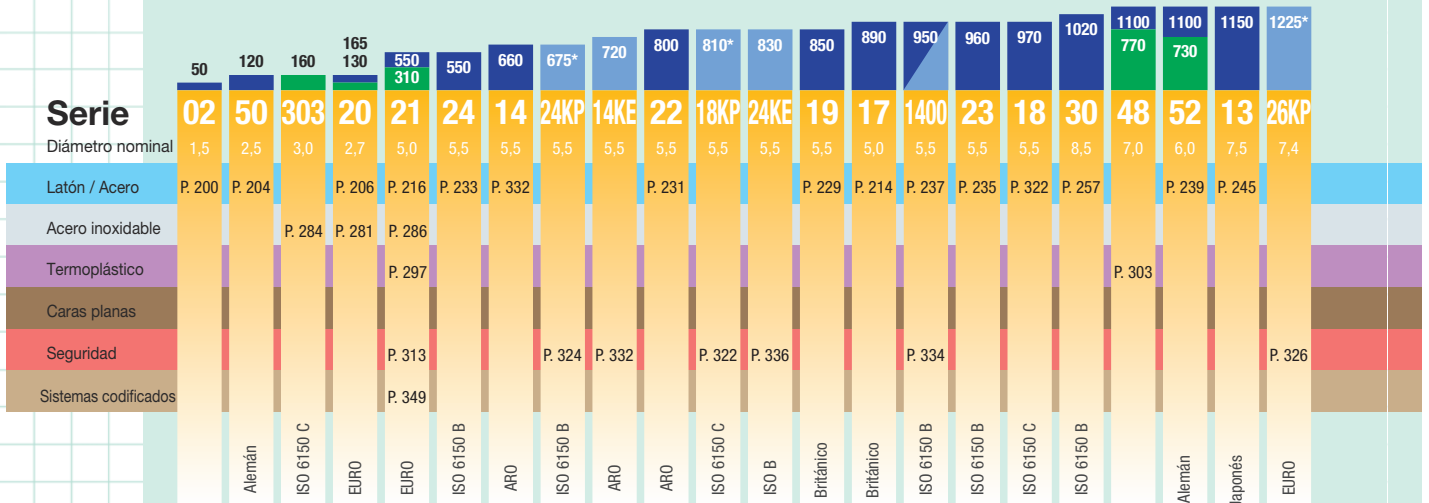

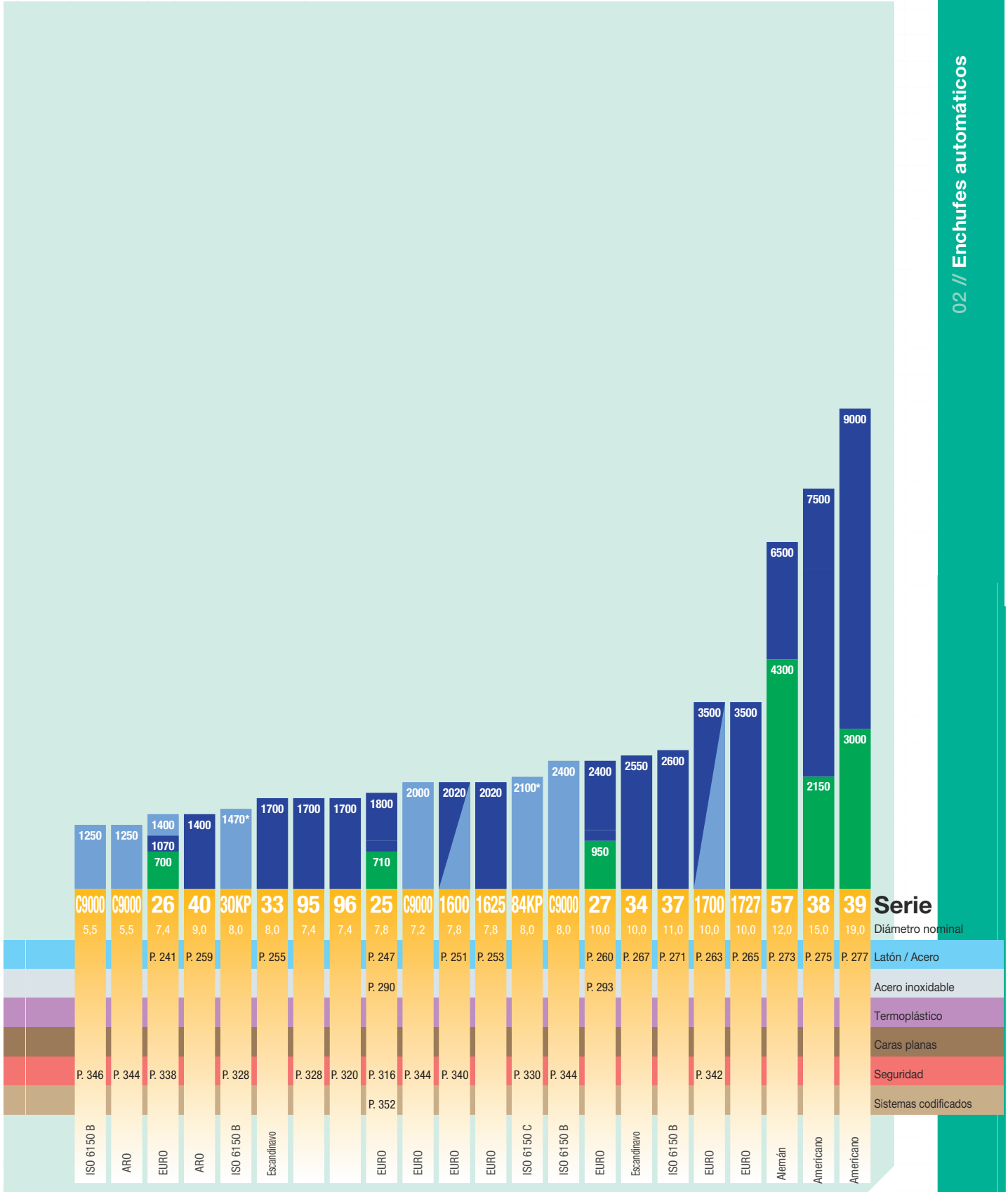





Nuestra gama de prestaciones de un vistazo

Caudal de agua

Con este diagrama de caudal, puede identificar, de un vistazo, la serie de enchufe automático adecuada para su aplicación y la presión de funcionamiento correspondiente.

Muchas de las series enumeradas a continuación también están disponibles en versión KF de paso directo.

-  Caudal KF (l/min.) – sistemas de enchufe automático directo
 - Particularmente adecuado para aplicaciones de manipulación de neumáticos y fluidos
-  Caudal KA (l/min.) – sistemas de enchufe automático de simple obturación
 - Particularmente adecuado para las aplicaciones neumáticas
-  Caudal KB (l/min.) – sistemas de enchufe de doble obturación
 - Particularmente adecuado para aplicaciones de manejo de fluidos
-  Caudal KL (l/min.) – sistemas de enchufe automático sin fugas
 - Particularmente adecuado para aplicaciones de manejo de fluidos

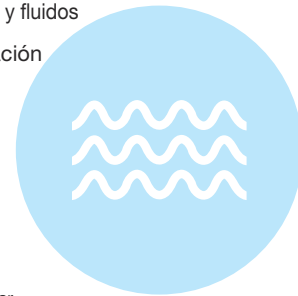

Los detalles se refieren al caudal de agua en litros/minuto.

Datos de medición generados de acuerdo con la norma ISO 7241/2:2000, caída de presión 0,5 bar

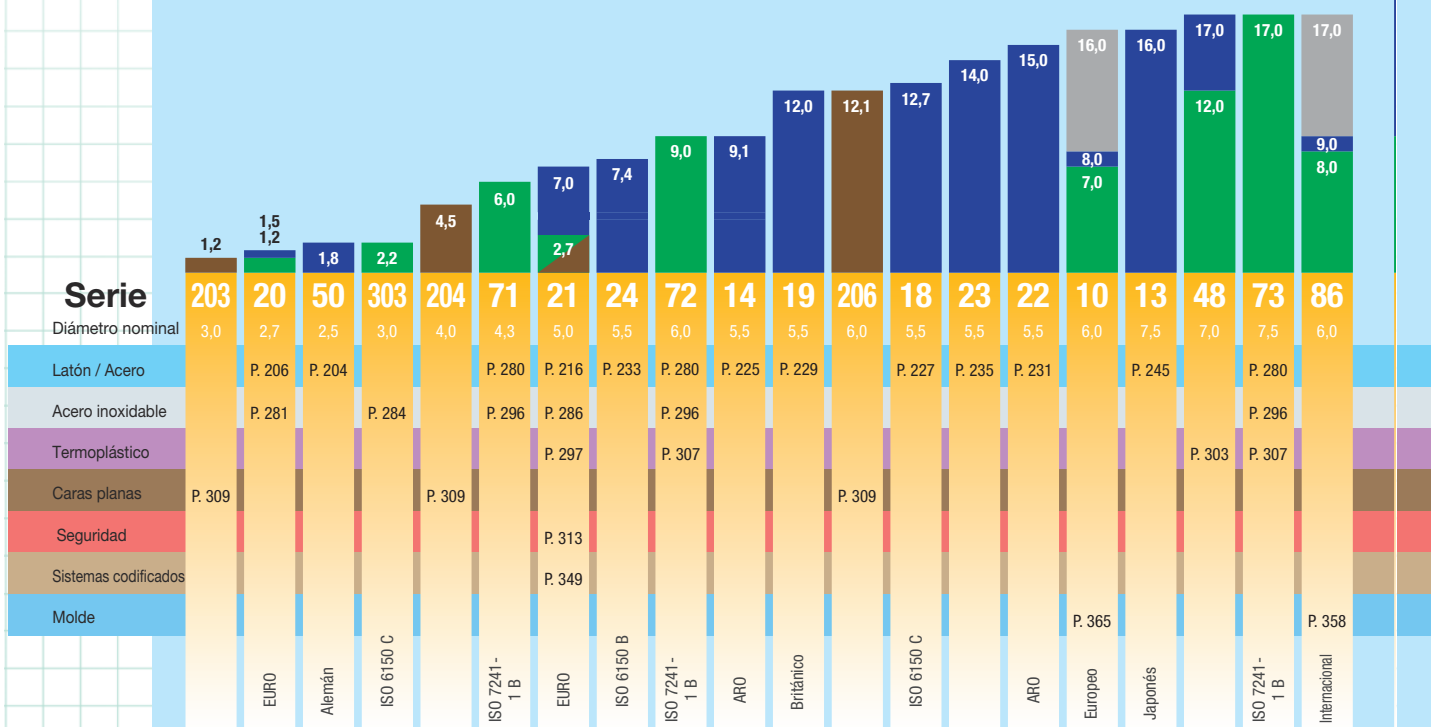

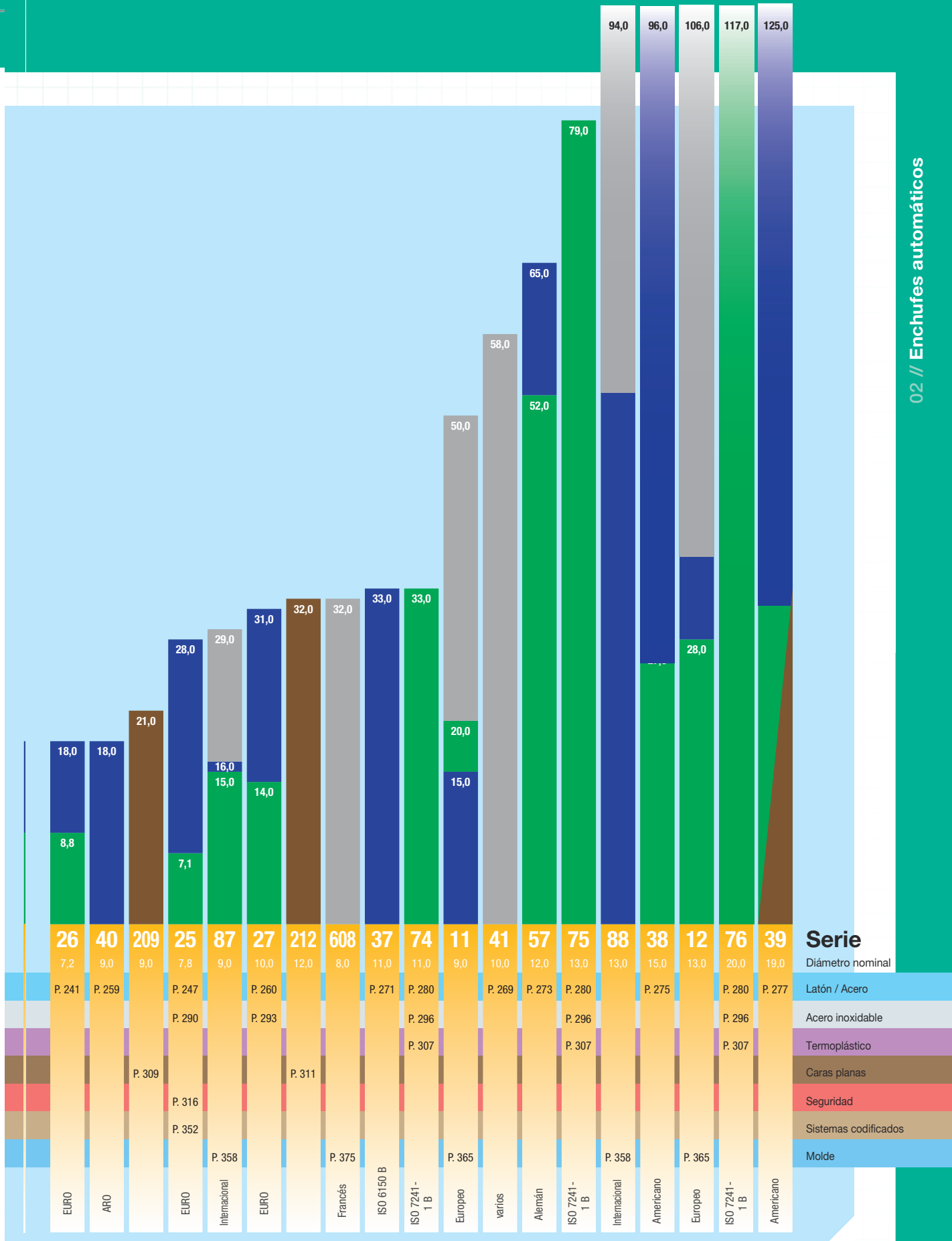



02 // Enchufes automáticos

Serie

- Diámetro nominal
- Latón / Acero
- Acero inoxidable
- Termoplástico
- Caras planas
- Seguridad
- Sistemas codificados
- Molde

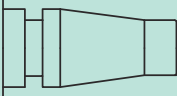

Lista de referencias cruzadas

	Legris P/N	Rectus P/N*	Catálogo Rectus más cercano P/N**	Página
Serie 20 Perfil de Euro Diámetro nominal: 2,7 	9087 20 19	20SFAM05MXN		207
	9087 20 10	20SFAW10MXN		207
	9086 20 19	20SFIM05MXN		207
	9086 20 10	20SFIW10MXN		207
	9085 20 03	20SFTF03MXN		208
	9085 20 04	20SFTF04MXN		208
	9085 20 05	20SFTF05MXN		208
	9095 20 03	20SFTS03MXN		208
	9095 20 04	20SFTS04MXN		208
	9201 20 19	20KBAM05MPN		208
	9201 20 10	20KBAW10MPN		208
	9214 20 19	20KBIM05MPN		209
	9214 20 10	20KBIW10MPN		209
	9226 20 03	20KBTS03MPN		209
	9226 20 04	20KBTS04MPN		209
	9287 20 19	20SBAM05MPN		210
	9287 20 10	20SBAW10MPN		210
	9286 20 19	20SBIM05MPN		210
	9286 20 10	20SBIW10MPN		210
	9285 20 03	20SBTF03MPN		210
9285 20 04	20SBTF04MPN		210	
9285 20 05	20SBTF05MPN		210	
Serie 17 Perfil británico Diámetro nominal: 5 	9105 17 13	17KAAK13SPN		214
	9105 17 21	17KAAK21SPN		214
	9114 17 13	17KAIW13SPN		214
	9114 17 17	17KAIW17SPN		214
	9114 17 21	17KAIW21SPN		214
	9084 17 13	17SFAK13SXN		215
	9086 17 13	17SFIW13SXN		215
	Serie 21 Perfil de Euro Diámetro nominal: 5 	9087 21 10	21SFAW10MXN	
9087 21 13		21SFAW13MXN		218
9086 21 10		21SFIW10MXN		218
9086 21 13		21SFIW13MXN		218
9085 21 04		21SFTF04MXN		218
9085 21 06		21SFTF06MXN		218
9085 21 08		21SFTF08MXN		218
9095 21 04		21SFTS04MXN		219
9095 21 06		21SFTS06MXN		219
9095 21 08		21SFTS08MXN		219
9201 21 10		21KBAW10MPN		219
9201 21 13		21KBAW13MPN		219
9214 21 10		21KBIW10MPN		219
9214 21 13		21KBIW13MPN		219
9223 21 04		21KBTF04MPN		220
9223 21 06		21KBTF06MPN		220
9223 21 08		21KBTF08MPN		220
9226 21 04		21KBTS04MPN		220
9226 21 06		21KBTS06MPN		220
9226 21 08		21KBTS08MPN		220

* El mismo producto que el de Legris

** Se recomienda la versión Rectus más cercana (la diferencia puede ser el enchapado, el material de la corredera, el recubrimiento, ...)

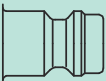
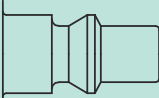
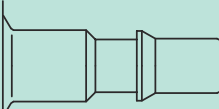
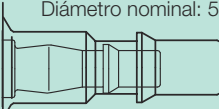
Lista de referencias cruzadas

	Legris P/N	Rectus P/N*	Catálogo Rectus más cercano P/N**	Página
Serie 21 Perfil de Euro Diámetro nominal: 5 	9287 21 10	21SBAW10MPN		221
	9287 21 13	21SBAW13MPN		221
	9286 21 10	21SBIW10MPN		221
	9286 21 13	21SBIW13MPN		221
	9285 21 04	21SBTF04MPN		221
	9285 21 06	21SBTF06MPN		221
	9285 21 08	21SBTF08MPN		221
Serie 14 Perfil de ARO Diámetro nominal: 5,5 	9101 14 13		14KAAW13MPX	225
	9101 14 17		14KAAW17MPX	225
	9101 14 21		14KAIW21MPX	225
	9114 14 13		14KAIW13MPX	225
	9114 14 17		14KAIW17MPX	225
	9114 14 21		14KAIW21MPX	225
	9123 14 06		14KATF06MPX	225
	9123 14 08		14KATF08MPX	225
	9123 14 09		14KATF09MPX	225
	9123 14 10		14KATF10MPX	225
9123 14 13		14KATF13MPX	225	
Serie 18 ISO 6150 C Perfil Diámetro nominal: 5,5 	9101 18 13		18KAAK13MPN	227
	9101 18 17		18KAAK17MPN	227
	9114 18 13	18KAIW13MPN		227
	9114 18 17	18KAIW17MPN		227
	9123 18 06	18KATF06MPN		227
	9123 18 08	18KATF08MPN		227
	9123 18 10	18KATF10MPN		227
	9087 18 13	18SFAW13SXN		228
	9087 18 17	18SFAW17SXN		228
	9086 18 13	18SFIW13SXN		228
	9086 18 17	18SFIW17SXN		228
	9085 18 06	18SFTF06SXN		228
	9085 18 08	18SFTF08SXN		228
9085 18 10	18SFTF10SXN		228	
Serie 19 Perfil británico Diámetro nominal: 5,5 	9105 19 13	19KAAK13MPN		229
	9105 19 17	19KAAK17MPN		229
	9114 19 13	19KAIW13MPN		229
	9123 19 06	19KATF06MPN		229
	9084 19 13	19SFAK13SXN		230
	9085 19 10	19SFTF10SXN		230
Serie 22 Perfil de ARO Diámetro nominal: 5,5 	9105 22 13	22KAAK13MPN		231
	9105 22 17	22KAAK17MPN		231
	9105 22 21	22KAAK21MPN		231
	9114 22 13	22KAIW13MPN		231
	9114 22 17	22KAIW17MPN		231
	9114 22 21	22KAIW21MPN		231
	9123 22 08	22KATF08MPN		231
	9123 22 10	22KATF10MPN		231
	9084 22 13	22SFAK13SXN		232
	9084 22 17	22SFAK17SXN		232

* El mismo producto que el de Legris

** Se recomienda la versión Rectus más cercana (la diferencia puede ser el enchapado, el material de la corredera, el recubrimiento, ...)

Lista de referencias cruzadas

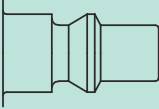
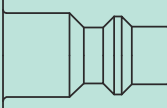
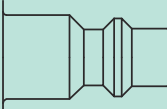
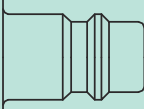
	Legris P/N	Rectus P/N*	Catálogo Rectus más cercano P/N**	Página
Serie 22 Perfil de ARO Diámetro nominal: 5,5 	9084 22 21	22SFAK21SXN		232
	9086 22 13	22SFIW13SXN		232
	9086 22 17	22SFIW17SXN		232
	9086 22 21	22SFIW21SXN		232
	9085 22 06	22SFTF06SXN		232
	9085 22 08	22SFTF08SXN		232
	9085 22 09	22SFTF09SXN		232
	9085 22 10	22SFTF10SXN		232
	9085 22 13	22SFTF13SXN		232
Serie 24 Perfil ISO 6150 B Diámetro nominal: 5,5 	9101 24 13	24KAAW13MPN		233
	9101 24 17	24KAAW17MPN		233
	9101 24 21	24KAAW21MPN		233
	9114 24 13	24KAIW13MPN		233
	9114 24 17	24KAIW17MPN		233
	9114 24 21	24KAIW21MPN		233
	9123 24 06	24KATF06MPN		234
	9123 24 08	24KATF08MPN		234
	9123 24 10	24KATF10MPN		234
Serie 23 Perfil ISO 6150 B Diámetro nominal: 5,5 	9101 23 13	23KAAW13MPN		235
	9101 23 17	23KAAW17MPN		235
	9101 23 21		23KAAK21MPN	235
	9114 23 13	23KAIW13MPN		235
	9114 23 17	23KAIW17MPN		235
	9114 23 21	23KAIW21MPN		235
	9123 23 06	23KATF06MPN		236
	9123 23 08	23KATF08MPN		236
	9123 23 10	23KATF10MPN		236
	9087 23 10	23SFAW10SXN		236
	9087 23 13	23SFAW13SXN		236
	9087 23 17	23SFAW17SXN		236
	9087 23 21	23SFAW21SXN		236
	9086 23 10	23SFIW10SXN		236
	9086 23 13	23SFIW13SXN		236
	9086 23 17	23SFIW17SXN		236
	9086 23 21	23SFIW21SXN		236
	9085 23 06	23SFTF06SXN		236
9085 23 08	23SFTF08SXN		236	
	9085 23 10	23SFTF10SXN		236
Serie 26 Perfil de Euro Diámetro nominal: 7,2 	9101 26 10	26KAAW10MPN		241
	9101 26 13	26KAAW13MPN		241
	9101 26 17	26KAAW17MPN		241
	9101 26 21	26KAAW21MPN		241
	9114 26 13	26KAIW13MPN		241
	9114 26 17	26KAIW17MPN		241
		9114 26 21	26KAIW21MPN	

* El mismo producto que el de Legris

** Se recomienda la versión Rectus más cercana (la diferencia puede ser el enchapado, el material de la corredera, el recubrimiento, ...)

Lista de referencias cruzadas

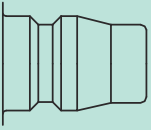
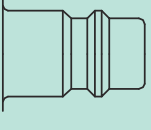
	Legris P/N	Rectus P/N*	Catálogo Rectus más cercano P/N**	Página
Serie 13 Perfil japonés Diámetro nominal: 7,5 	9105 13 13		13KAAK13MPX	245
	9114 13 13		13KAIW13MPX	245
	9114 13 21		13KAIW21MPX	245
	9123 13 13		13KATF13MPX	245
	9086 13 13	13SFIW13SXN		246
	9085 13 13	13SFTF13SXN		246
Serie 25 Perfil de Euro Diámetro nominal: 7,8 	9087 25 10	25SFAW10SXZ		248
	9087 25 13	25SFAW13SXZ		248
	9087 25 17	25SFAW17SXZ		248
	9087 25 21	25SFAW21SXZ		248
	9086 25 10	25SFIW10SXZ		248
	9086 25 13	25SFIW13SXZ		248
	9086 25 17	25SFIW17SXZ		248
	9086 25 21	25SFIW21SXZ		248
	9085 25 06	25SFTF06SXZ		249
	9085 25 08	25SFTF08SXZ		249
	9085 25 09	25SFTF09SXZ		249
	9085 25 10	25SFTF10SXZ		249
	9085 25 13	25SFTF13SXZ		249
	9201 25 13	25KBAW13MPN		249
	9201 25 17	25KBAW17MPN		249
	9201 25 21	25KBAW21MPN		249
	9214 25 13	25KBIW13MPN		249
	9214 25 17	25KBIW17MPN		249
	9214 25 21	25KBIW21MPN		249
	9223 25 06	25KBTF06MPN		249
	9223 25 08	25KBTF08MPN		249
	9223 25 10	25KBTF10MPN		249
	9223 25 13	25KBTF13MPN		249
	9287 25 10	25SBAW10MPN		250
	9287 25 13	25SBAW13MPN		250
	9287 25 17	25SBAW17MPN		250
	9287 25 21	25SBAW21MPN		250
	9286 25 13	25SBIW13MPN		250
	9286 25 17	25SBIW17MPN		250
	9286 25 21	25SBIW21MPN		250
	9285 25 06	25SBTF06MPN		250
9285 25 08	25SBTF08MPN		250	
9285 25 10	25SBTF10MPN		250	
9285 25 13	25SBTF13MPN		250	

* El mismo producto que el de Legris

** Se recomienda la versión Rectus más cercana (la diferencia puede ser el enchapado, el material de la corredera, el recubrimiento, ...)

Lista de referencias cruzadas

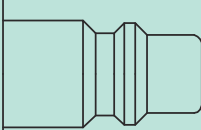
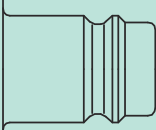
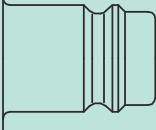
	Legris P/N	Rectus P/N*	Catálogo Rectus más cercano P/N**	Página
Serie 30 Perfil ISO 6150 B Diámetro nominal: 8,5 	9101 30 13		30KAAW13SPX	257
	9101 30 17		30KAAW17SPX	257
	9101 30 21		30KAAW21SPX	257
	9114 30 13		30KAW13SPX	257
	9114 30 17		30KAW17SPX	257
	9114 30 21		30KAW21SPX	257
	9123 30 08		30KATF08SPX	257
	9123 30 10		30KATF10SPX	257
	9123 30 13		30KATF13SPX	257
	9087 30 13	30SFAW13SXN		258
	9087 30 17	30SFAW17SXN		258
	9087 30 21	30SFAW21SXN		258
	9086 30 13	30SFIW13SXN		258
	9086 30 17	30SFIW17SXN		258
	9086 30 21	30SFIW21SXN		258
	9085 30 08	30SFTF08SXN		258
	9085 30 10	30SFTF10SXN		258
9085 30 13	30SFTF13SXN		258	
Serie 27 Perfil de Euro Diámetro nominal: 10 	9087 27 17		27SFAK17SXN	261
	9087 27 21		27SFAK21SXN	261
	9087 27 27		27SFAK26SXN	261
	9086 27 17	27SFIW17SXN		261
	9086 27 21	27SFIW21SXN		261
	9086 27 27	27SFIW26SXN		261
	9085 27 08	27SFTF08SXN		261
	9085 27 10	27SFTF10SXN		261
	9085 27 13	27SFTF13SXN		261
	9085 27 19	27SFTF19SXN		261
	9287 27 17		27SBAK17MPN	261
	9287 27 21		27SBAK21MPN	261
	9287 27 27		27SBAK26MPN	261
	9286 27 17	27SBIW17MPN		262
	9286 27 21	27SBIW21MPN		262
	9286 27 27	27SBIW26MPN		262
	9285 27 08	27SBTF08MPN		262
9285 27 10	27SBTF10MPN		262	
9285 27 13	27SBTF13MPN		262	
9285 27 19	27SBTF19MPN		262	
Serie 1700 Perfil de Euro Diámetro nominal: 10 	9201 27 17		27KBAK17BPN	261
	9201 27 21		27KBAK21BPN	261
	9201 27 27		27KBAK26BPN	261
	9214 27 17		27KBIW17BPN	261
	9214 27 21		27KBIW21BPN	261
	9214 27 27		27KBIW26BPN	261
	9223 27 08		27KBTF08BPN	261
	9223 27 10		27KBTF10BPN	261
	9223 27 13		27KBTF13BPN	261
	9223 27 19		27KBTF19BPN	261

* El mismo producto que el de Legris

** Se recomienda la versión Rectus más cercana (la diferencia puede ser el enchapado, el material de la corredera, el recubrimiento, ...)

Lista de referencias cruzadas

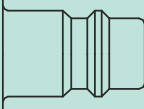
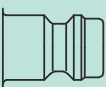
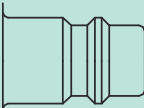
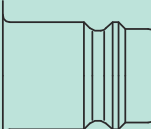
	Legris P/N	Rectus P/N*	Catálogo Rectus más cercano P/N**	Página
Serie 20 Perfil de Euro Diámetro nominal: 2,7 	9201X20 19	20KBAM05EVX		282
	9201X20 10	20KBAW10EVX		282
	9214X20 19	20KBIM05EVX		282
	9214X20 10	20KBIW10EVX		282
	9287X20 19	20SBAM05EVX		283
	9287X20 10	20SBAW10EVX		283
	9286X20 10	20SBIW10EVX		283
Serie 21 Perfil de Euro Diámetro nominal: 5 	9087X21 10	21SFAW10EXX		287
	9087X21 13	21SFAW13EXX		287
	9086X21 10	21SFIW10EXX		287
	9086X21 13	21SFIW13EXX		287
	9201X21 10	21KBAW10EVX		288
	9201X21 13	21KBAW13EVX		288
	9214X21 10	21KBIW10EVX		288
	9214X21 13	21KBIW13EVX		288
	9287X21 10	21SBAW10EVX		288
	9287X21 13	21SBAW13EVX		288
	9286X21 10	21SBIW10EVX		288
	9286X21 13	21SBIW13EVX		288
	Serie 25 Perfil de Euro Diámetro nominal: 7,4 	9087X25 21	25SFAW21EXX	
9086X25 13		25SFIW13EXX		291
9086X25 17		25SFIW17EXX		291
9201X25 13		25KBAW13EVX		291
9201X25 17		25KBAW17EVX		291
9201X25 21		25KBAW21EVX		291
9214X25 13		25KBIW13EVX		291
9214X25 17		25KBIW17EVX		292
9214X25 21		25KBIW21EVX		292
9287X25 13		25SBAW13EVX		292
9287X25 17		25SBAW17EVX		292
9287X25 21		25SBAW21EVX		292
9286X25 13		25SBIW13EVX		292
9286X25 17		25SBIW17EVX		292
Serie 27 Perfil de Euro Diámetro nominal: 10 	9087X27 21	27SFAW21EXX		294
	9087X27 27	27SFAW26EXX		294
	9086X27 17	27SFIW17EXX		294
	9201X27 17	27KBAW17EVX		294
	9201X27 21	27KBAW21EVX		294
	9201X27 27	27KBAW26EVX		294
	9214X27 17	27KBIW17EVX		294
	9214X27 21	27KBIW21EVX		294
	9214X27 27	27KBIW26EVX		294
	9287X27 17	27SBAW17EVX		295
	9287X27 21	27SBAW21EVX		295
	9287X27 27	27SBAW26EVX		295
	9286X27 17	27SBIW17EVX		295
	9286X27 21	27SBIW21EVX		295

* El mismo producto que el de Legris

** Se recomienda la versión Rectus más cercana (la diferencia puede ser el enchapado, el material de la corredera, el recubrimiento, ...)

Serie 02 - Latón / Acero

Diámetro nominal
1,5 = 1,8 mm²



El enchufe automático mini industrial más pequeño para aplicaciones de aire y gas. Principalmente en medicina, didáctica y construcción de modelos. Parcialmente adecuado para líquidos debido a su tamaño. Sistema de enchufe automático con una sola mano. Dimensiones extremadamente pequeñas.

- Disponible a petición:
 - en material de latón sin niquelado
 - con conexiones finales adicionales
 - otras juntas para diferentes rangos de temperatura y fluidos



Presión de trabajo*:
hasta 35 bar

Material:

- Enchufe: Latón niquelado
- Acoplador: Latón niquelado
- Junta: NBR

Temperatura de trabajo:
-20°C hasta +100°C (NBR)

Caudal de aire:
50 l/min.
presión de entrada 6 bar, caída de presión 0,5 bar

Caudal de agua:
0,6 l/min.
caída de presión de 0,5 bar

* máxima presión estática de trabajo con un factor de diseño de 4 a 1.

 Simple obturación

02KAAM Enchufe con válvula, rosca macho

Latón niquelado, NBR

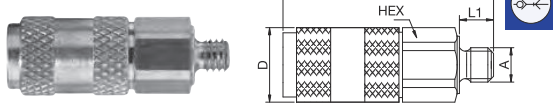

A	HEX	L	L1	D	
M3	02KAAM03MPN	6	19	3	6,5

 Simple obturación

02KATF Enchufe con válvula, conexión manguera

Latón niquelado, NBR

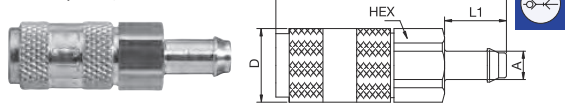

A	HEX	L	L1	D	
2	02KATF02MPN	6	21	5,5	6,5
3	02KATF03MPN	6	22	5,5	6,5

02KAIM Enchufe con válvula, rosca hembra

Latón niquelado, NBR

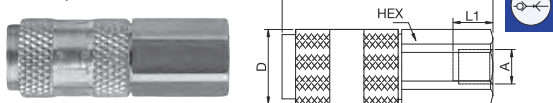

A	HEX	L	L1	D	
M3	02KAIM03MPN	6	19	3	6,5

02KATS Enchufe con válvula, montaje en panel con manguera

Latón niquelado, NBR

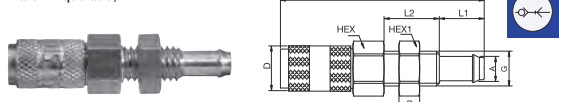

A	HEX	HEX1	B	G	L	L1	L2	D	
2	02KATS02MPN	7	7	3	M5	29	5,5	8	6,5

Serie 02 - Latón / Acero



Simple obturación

02SFAM Acoplador sin válvula, macho

Latón niquelado

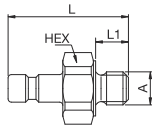

A	HEX	L	L1
M3 02SFAM03MXN	6	11	3

02SFIM Acoplador sin válvula, hembra

Latón niquelado

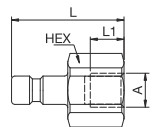

A	HEX	L	L1
M3 02SFIM03MXN	6	10	3

02SFTF Acoplador sin válvula, conexión manguera

Latón niquelado

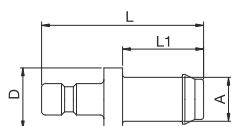

A	L	L1	D
2 02SFTF02MXN	12	5,5	4
3 02SFTF03MXN	13	6,5	5

02SFTS Acoplador sin válvula, montaje en panel con manguera

Latón niquelado

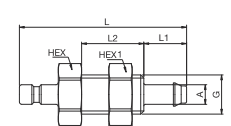

A	HEX	HEX1	B	G	L	L1	L2
2 02SFTS02MXN	7	7	3	M5	22	5,5	8

Serie Mini

Diámetro nominal
2



La serie mini ofrece soluciones de ahorro de espacio para la desconexión frecuente de tubos o herramientas neumáticas.

- Compacto y ergonómico
- Fácil identificación de los circuitos
- Fácil desconexión / operación con una sola mano

propio perfil



Presión de trabajo*:
hasta 20 bar

Material:

- Enchufe: Polímero técnico, latón niquelado
- Acoplador: latón niquelado
- Junta: NBR

Temperatura de trabajo:
-20°C hasta +60°C (NBR)

Caudal de aire:
165 NI/min.





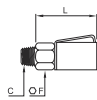

presión de entrada 6 bar, caída de presión 0,6 bar

 Simple obturación

0171 Enchufe con válvula, BSPT macho y rosca métrica paralela

Polímero técnico, latón niquelado, NBR



DN	C		E	F	L
2	M7x1		6	10	21
2	R1/8		7,5	10	21
2	R1/8		7,5	10	21
2	R1/8		7,5	10	21
2	R1/8		7,5	10	21
2	R1/8		7,5	10	21

Con obturación
Serie Mini (DN 2): caudal con simple obturación= 165 NI/min

 Simple obturación

0184 Acoplador sin válvula, rosca macho BSPT

Latón niquelado



DN	C		F	L
2	R1/8		10	13

Acoplador sin obturación

0181 Acoplador sin válvula, rosca macho BSPT

Latón niquelado

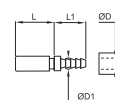

DN	ØD	ØD1		L	L1
2	3	3,3		11,5	13,5

Acoplador sin obturación

Serie Mini

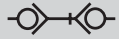

Doble obturación

0183 Acoplador con válvula, rosca macho BSPT

Latón niquelado, NBR



DN	C		F	L
2	R1/8	0183 02 10	10	13

Acoplador con obturación

02 // Enchufes automáticos

Latón / Acero

Serie Mini

Serie 50 - Latón / Acero

Diámetro nominal
2,5 = 5 mm²



Enchufe automático mini industrial, puede ser usado con varios medios. Sistema de enchufe automático con una sola mano. Este sistema es extremadamente fácil de manejar y se destaca por sus pequeñas dimensiones de instalación.

- Disponible a petición:
 - en material de latón con recubrimiento de níquel
 - con conexiones finales adicionales
 - otras juntas para diferentes rangos de temperatura y fluidos

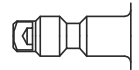

Perfil alemán



Presión de trabajo*:
hasta 35 bar

Material:

- Enchufe: Latón
- Acoplador: Latón
- Junta: NBR

Temperatura de trabajo:
-20°C hasta +100°C (NBR)

Caudal de aire:

120 l/min.
presión de entrada 6 bar, caída de presión 0,5 bar

Caudal de agua:

1,8 l/min.
caída de presión de 0,5 bar

* máxima presión estática de trabajo con un factor de diseño de 4 a 1.

 Simple obturación

50KAAW Enchufe con válvula, rosca macho

Latón, NBR

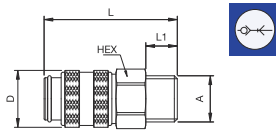

A	HEX	L	L1	D
G1/8	50KAAW10MPXS	14	36	7 16
G1/4	50KAAW13MPXS	17	38	9 16

 Simple obturación

50KATF Enchufe con válvula, conexión manguera

Latón, NBR

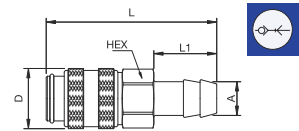

A	HEX	L	L1	D
4	50KATF04MPXS	14	46	17 16
6	50KATF06MPXS	14	46	17 16

50KAIW Enchufe con válvula, rosca hembra

Latón, NBR

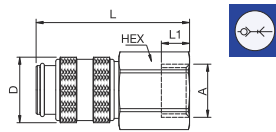

A	HEX	L	L1	D
G1/8	50KAIW10MPXS	14	36	9 16
G1/4	50KAIW13MPXS	17	38	9 16

Serie 50 - Latón / Acero

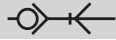

Simple obturación

50SFAW Acoplador sin válvula, rosca macho

Latón

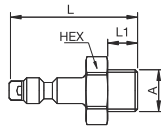

A



HEX L L1

G1/8 50SFAW10MXX

14 30 7

50SFIW Acoplador sin válvula, rosca hembra

Latón

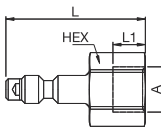

A



HEX L L1

G1/8 50SFIW10MXX

14 30 7

50SFTF Acoplador sin válvula, conexión manguera

Latón

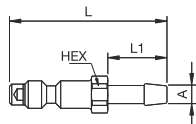

A



HEX L L1

4 50SFTF04MXX

7 35 13

6 50SFTF06MXX

7 35 13

Serie 20 - Latón / Acero

Diámetro nominal
2,7 = 6 mm²



Enchufe automático mini industrial con perfil de uso internacional. Uso frecuente en tecnología médica y en química/farmacia. Sistema de enchufe automático con operación de una sola mano. Amplia gama de aplicaciones con diferentes medios.

- Disponible a petición:
 - con conexiones finales adicionales
 - otras juntas para diferentes rangos de temperatura y fluidos



Perfil de Euro



Simple obturación

Presión de trabajo*:
hasta 35 bar

Material:

- Enchufe: Latón
- Acoplador: Latón
- Junta: NBR

Temperatura de trabajo:
-20°C hasta +100°C (NBR)

Caudal de aire:

165 l/min.
presión de entrada 6 bar, caída de presión 0,5 bar

Caudal de agua:

1,5 l/min.
caída de presión de 0,5 bar



Doble obturación

Presión de trabajo*:
hasta 35 bar

Material:

- Enchufe: Latón
- Acoplador: Latón
- Junta: NBR

Temperatura de trabajo:
-20°C hasta +100°C (NBR)

Caudal de aire:

130 l/min.
presión de entrada 6 bar, caída de presión 0,5 bar

Caudal de agua:

1,2 l/min.
caída de presión de 0,5 bar

* máxima presión estática de trabajo con un factor de diseño de 4 a 1.



Simple obturación



Simple obturación

20KAA Enchufe con válvula, rosca macho

Latón, NBR

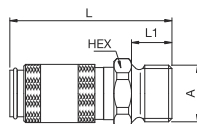

A	HEX	L	L1	D	Versión	
M5	20KAAM05MPX	9	26	5	10	Latón
	20KAAM05MPN	9	26	5	10	Latón niquelado
G1/8	20KAAW10MPX	11	28	7	10	Latón
	20KAAW10MPN	11	28	7	10	Latón niquelado

20KAI Enchufe con válvula, rosca hembra

Latón, NBR

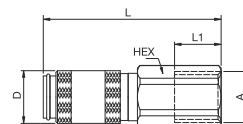

A	HEX	L	L1	D	Versión	
M5	20KAIM05MPX	9	26	5	10	Latón
	20KAIM05MPN	9	26	5	10	Latón niquelado
G1/8	20KAIW10MPX	12	28	7	10	Latón
	20KAIW10MPN	12	28	7	10	Latón niquelado

Serie 20 - Latón / Acero

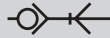

Simple obturación

20KATF Enchufe con válvula, conexión manguera

Latón, NBR

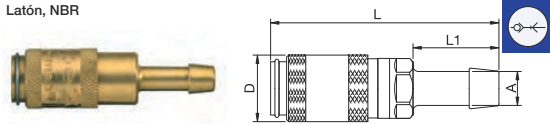

A		L	L1	D	Versión
3	20KATF03MPX	35	13	10	Latón
	20KATF03MPN	35	13	10	Latón niquelado
4	20KATF04MPX	35	13	10	Latón
	20KATF04MPN	35	13	10	Latón niquelado
5	20KATF05MPX	35	13	10	Latón
	20KATF05MPN	35	13	10	Latón niquelado

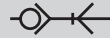

Simple obturación

20KATS Enchufe con válvula, montaje en panel con manguera

Latón, NBR

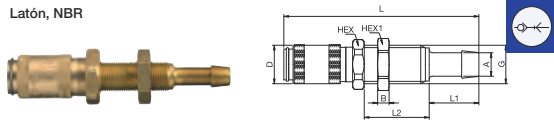

A		HEX	HEX1	B	G	L	L1	L2	D	Versión
3	20KATS03MPX	12	11	3	M7x0,5	51	13	17	10	Latón
	20KATS03MPN	12	11	3	M7x0,5	51	13	17	10	Latón niquelado
4	20KATS04MPX	12	11	3	M7x0,5	51	13	17	10	Latón
	20KATS04MPN	12	11	3	M7x0,5	51	13	17	10	Latón niquelado

20KAKO Enchufe con válvula, con conexión de manguera de plástico

Latón, NBR

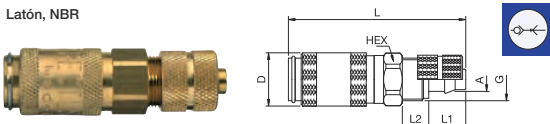

A		HEX	G	L	L1	L2	D	Versión
3 x 4	20KAKO04MPX	9	M7x0,5	34	7	5	10	Latón
	20KAKO04MPN	9	M7x0,5	34	7	5	10	Latón niquelado
3 x 5	20KAKO05MPX	9	M7x0,5	34	7	5	10	Latón
	20KAKO05MPN	9	M7x0,5	34	7	5	10	Latón niquelado
4 x 6	20KAKO06MPX	9	M8x0,5	34	7	5	10	Latón
	20KAKO06MPN	9	M8x0,5	34	7	5	10	Latón niquelado

20KARP Enchufe con válvula, Push-In

Latón niquelado, NBR

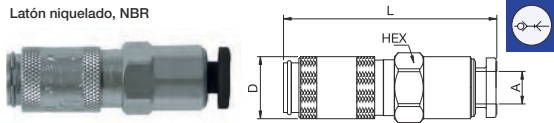

A		HEX	L	D
4	20KARP04MPN	10	35	10

20SFA Acoplador sin válvula, rosca macho

Latón

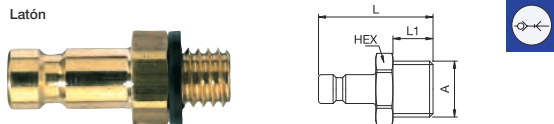

A		HEX	L	L1	Versión
M5	20SFAM05MXX	7	18	5	Latón
	20SFAM05MXN	9087 20 19	7	18	5
G1/8	20SFAW10MXX	11	20	7	Latón
	20SFAW10MXN	9087 20 10	11	20	7

20KAKS Enchufe con válvula, montaje en panel con conexión de manguera plástica

Latón, NBR

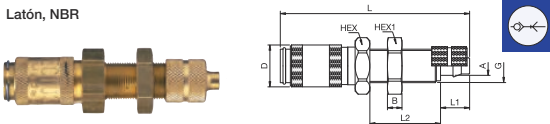

A		HEX	HEX1	B	G	L	L1	L2	D	Versión
3 x 4	20KAKS04MPX	12	11	3	M7x0,5	45	7	17	10	Latón
	20KAKS04MPN	12	11	3	M7x0,5	45	7	17	10	Latón niquelado
3 x 5	20KAKS05MPX	12	11	3	M7x0,5	45	7	17	10	Latón
	20KAKS05MPN	12	11	3	M7x0,5	45	7	17	10	Latón niquelado
4 x 6	20KAKS06MPX	12	11	3	M8x0,5	45	7	17	10	Latón
	20KAKS06MPN	12	11	3	M8x0,5	45	7	17	10	Latón niquelado

20SFI Acoplador sin válvula, rosca hembra

Latón

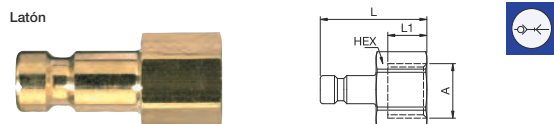

A		HEX	L	L1	Versión
M5	20SFIM05MXX	7	17	5	Latón
	20SFIM05MXN	9086 20 19	7	17	5
G1/8	20SFIW10MXX	12	19	7	Latón
	20SFIW10MXN	9086 20 10	12	19	7

Serie 20 - Latón / Acero



Simple obturación

20SFTF Acoplador sin válvula, conexión manguera

Latón

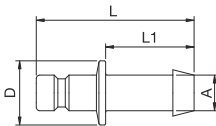

A			L	L1	D	Versión
3	20SFTF03MXX		24	13	7	Latón
	20SFTF03MXN	9085 20 03	24	13	7	Latón niquelado
4	20SFTF04MXX		24	13	7	Latón
	20SFTF04MXN	9085 20 04	24	13	7	Latón niquelado
5	20SFTF05MXX		22	13	9	Latón
	20SFTF05MXN	9085 20 05	22	13	9	Latón niquelado



Simple obturación

20SFTS Acoplador sin válvula, montaje en panel con manguera

Latón

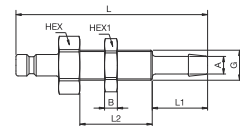
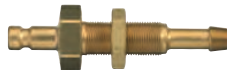

A			HEX	HEX1	B	G	L	L1	L2	Versión
3	20SFTS03MXX		12	11	3,5	M7x0,5	45	13	18	Latón
	20SFTS03MXN	9095 20 03	12	11	3,5	M7x0,5	45	13	18	Latón niquelado
4	20SFTS04MXX		12	11	3	M7x0,5	45	13	17	Latón
	20SFTS04MXN	9095 20 04	12	11	3	M7x0,5	45	13	17	Latón niquelado

20SFKO Acoplador sin válvula, con conexión de manguera de plástico

Latón

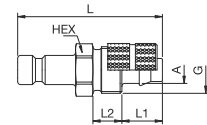

A		HEX	G	L	L1	L2	Versión
3 x 4	20SFKO04MXX	7	M7x0,5	25	7	5	Latón
	20SFKO04MXN	7	M7x0,5	25	7	5	Latón niquelado
3 x 5	20SFKO05MXX	7	M7x0,5	25	7	5	Latón
	20SFKO05MXN	7	M7x0,5	25	7	5	Latón niquelado
4 x 6	20SFKO06MXX	8	M8x0,5	25	7	5	Latón
	20SFKO06MXN	8	M8x0,5	25	7	5	Latón niquelado

20SFRP Acoplador sin válvula, Push-In

Latón niquelado, NBR

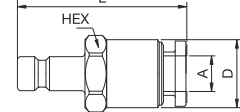

A		HEX	L	D
4	20SFRP04MPN	10	35	10

20SFKS Acoplador sin válvula, montaje en panel con conexión de manguera de plástico

Latón

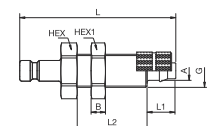
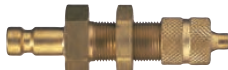

A		HEX	HEX1	B	G	L	L1	L2	Versión
3 x 4	20SFKS04MXX	11	11	3	M7x0,5	38	7	17	Latón
	20SFKS04MXN	11	11	3	M7x0,5	38	7	17	Latón niquelado
3 x 5	20SFKS05MXX	11	11	3	M7x0,5	38	7	17	Latón
	20SFKS05MXN	11	11	3	M7x0,5	38	7	17	Latón niquelado
4 x 6	20SFKS06MXX	12	12	3	M8x0,5	38	7	17	Latón
	20SFKS06MXN	12	12	3	M8x0,5	38	7	17	Latón niquelado



Doble obturación

20KBA Enchufe con válvula, rosca macho

Latón, NBR

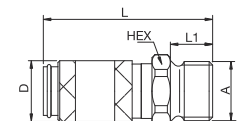

A		HEX	L	L1	D	Versión
M5	20KBAM05MPX	9	26	5	10	Latón
	20KBAM05MPN	9201 20 19	9	26	5	Latón niquelado
G1/8	20KBAW10MPX	11	28	7	10	Latón
	20KBAW10MPN	9201 20 10	11	28	7	Latón niquelado

Serie 20 - Latón / Acero

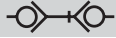

Doble obturación

20KBI Enchufe con válvula, rosca hembra

Latón, NBR

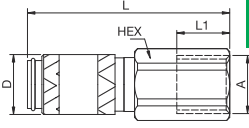

A	HEX	L	L1	D	Versión	
M5	20KBIM05MPX	9	26	5	10	Latón
	20KBIM05MPN	9	26	5	10	Latón niquelado
G1/8	20KBIW10MPX	12	28	7	10	Latón
	20KBIW10MPN	12	28	7	10	Latón niquelado

20KBTf Enchufe con válvula, conexión manguera

Latón, NBR

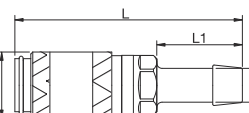

A	L	L1	D	Versión	
3	20KBTf03MPX	35	13	10	Latón
	20KBTf03MPN	35	13	10	Latón niquelado
4	20KBTf04MPX	35	13	10	Latón
	20KBTf04MPN	35	13	10	Latón niquelado
5	20KBTf05MPX	35	13	10	Latón
	20KBTf05MPN	35	13	10	Latón niquelado

20KBK0 Enchufe con válvula, con conexión de manguera de plástico

Latón, NBR

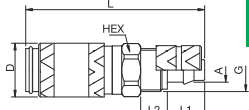

A	HEX	G	L	L1	L2	D	Versión	
3 x 4	20KBK004MPX	9	M7x0,5	34	7	5	10	Latón
	20KBK004MPN	9	M7x0,5	34	7	5	10	Latón niquelado
3 x 5	20KBK005MPX	9	M7x0,5	34	7	5	10	Latón
	20KBK005MPN	9	M7x0,5	34	7	5	10	Latón niquelado
4 x 6	20KBK006MPX	9	M8x0,5	34	7	5	10	Latón
	20KBK006MPN	9	M8x0,5	34	7	5	10	Latón niquelado



Doble obturación

20KBKS Enchufe con válvula, montaje en panel con conexión de manguera plástica

Latón, NBR

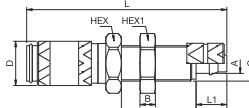

A	HEX	HEX1	B	G	L	L1	L2	D	Versión	
3 x 4	20KBKS04MPX	12	11	3	M7x0,5	45	7	17	10	Latón
	20KBKS04MPN	12	11	3	M7x0,5	45	7	17	10	Latón niquelado
3 x 5	20KBKS05MPX	12	11	3	M7x0,5	45	7	17	10	Latón
	20KBKS05MPN	12	11	3	M7x0,5	45	7	17	10	Latón niquelado
4 x 6	20KBKS06MPX	12	12	3,5	M8x0,5	45	7	17	10	Latón
	20KBKS06MPN	12	12	3,5	M8x0,5	45	7	17	10	Latón niquelado

20KBTS Enchufe con válvula, montaje en panel con manguera

Latón, NBR

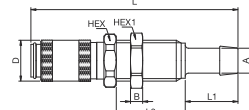

A	HEX	HEX1	B	G	L	L1	L2	D	Versión	
3	20KBTS03MPX	12	11	3	M7x0,5	51	13	17	10	Latón
	20KBTS03MPN	12	11	3	M7x0,5	51	13	17	10	Latón niquelado
4	20KBTS04MPX	12	11	3	M7x0,5	51	13	17	10	Latón
	20KBTS04MPN	12	11	3	M7x0,5	51	13	17	10	Latón niquelado

20KBRP Enchufe con válvula, Push-In

Latón niquelado, NBR

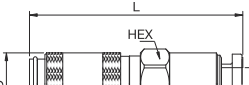

A	HEX	L	D	
4	20KBRP04MPN	10	35	10

Serie 20 - Latón / Acero

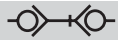

Doble obturación

20SBA Acoplador con válvula, rosca macho

Latón, NBR

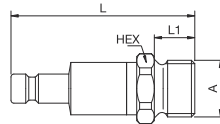

A	Icon	Icon	HEX	L	L1	Versión	
M5	Icon	Icon	20SBAM05MPX	9	28	5	Latón
			20SBAM05MPN	9287 20 19	9	28	5
G1/8	Icon	Icon	20SBAW10MPX	11	30	7	Latón
			20SBAW10MPN	9287 20 10	11	30	7

20SBI Acoplador con válvula, rosca hembra

Latón, NBR

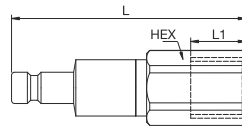
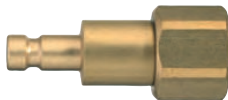

A	Icon	Icon	HEX	L	L1	Versión	
M5	Icon	Icon	20SBIM05MPX	9	26	5	Latón
			20SBIM05MPN	9286 20 19	9	26	5
G1/8	Icon	Icon	20SBIW10MPX	12	30	7	Latón
			20SBIW10MPN	9286 20 10	12	30	7

20SBTF Acoplador con válvula, conexión manguera

Latón, NBR

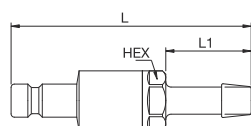
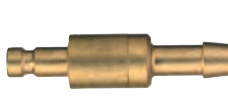

A	Icon	Icon	HEX	L	L1	Versión	
3	Icon	Icon	20SBTF03MPX	8	36	13	Latón
			20SBTF03MPN	9285 20 03	8	36	13
4	Icon	Icon	20SBTF04MPX	8	36	13	Latón
			20SBTF04MPN	9285 20 04	8	36	13
5	Icon	Icon	20SBTF05MPX	8	36	13	Latón
			20SBTF05MPN	9285 20 05	8	36	13



Doble obturación

20SBKO Acoplador con válvula, con conexión de manguera de plástico

Latón, NBR

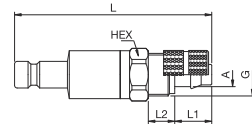

A	Icon	Icon	HEX	G	L	L1	L2	Versión	
3 x 4	Icon	Icon	20SBK004MPX	9	M7x0,5	30,5	7	5	Latón
			20SBK004MPN	9	M7x0,5	30,5	7	5	Latón niquelado
3 x 5	Icon	Icon	20SBK005MPX	9	M7x0,5	30,5	7	5	Latón
			20SBK005MPN	9	M7x0,5	30,5	7	5	Latón niquelado
4 x 6	Icon	Icon	20SBK006MPX	9	M8x0,5	30,5	7	5	Latón
			20SBK006MPN	9	M8x0,5	30,5	7	5	Latón niquelado

20SBKS Acoplador con válvula, montaje en panel con conexión de manguera plástica

Latón, NBR

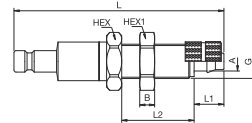
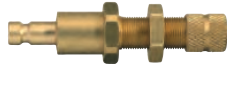

A	Icon	Icon	HEX	HEX1	B	G	L	L1	L2	D	Versión	
3 x 4	Icon	Icon	20SBKS04MPX	12	11	3	M7x0,5	46,5	7	17	10	Latón
			20SBKS04MPN	12	11	3	M7x0,5	46,5	7	17	10	Latón niquelado
3 x 5	Icon	Icon	20SBKS05MPX	12	11	3	M7x0,5	46,5	7	17	10	Latón
			20SBKS05MPN	12	11	3	M7x0,5	46,5	7	17	10	Latón niquelado
4 x 6	Icon	Icon	20SBKS06MPX	12	12	3,5	M8x0,5	46,5	7	17	10	Latón
			20SBKS06MPN	12	12	3,5	M8x0,5	46,5	7	17	10	Latón niquelado

20SBTS Acoplador con válvula, montaje en panel con manguera

Latón, NBR

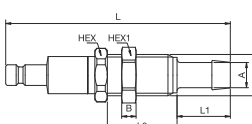
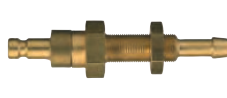

A	Icon	Icon	HEX	HEX1	B	G	L	L1	L2	Versión	
3	Icon	Icon	20SBTS03MPX	12	11	3	M7x0,5	52,5	13	17	Latón
			20SBTS03MPN	12	11	3	M7x0,5	52,5	13	17	Latón niquelado
4	Icon	Icon	20SBTS04MPX	12	11	3	M7x0,5	52,5	13	17	Latón
			20SBTS04MPN	12	11	3	M7x0,5	52,5	13	17	Latón niquelado

20SBRP Acoplador con válvula, Push-In

Latón niquelado, NBR

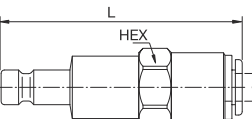

A	Icon	Icon	HEX	L
3 x 4	Icon	Icon	20SBRP04MPN	10 34

Mini Serie

Diámetro nominal
3



La serie mini ofrece soluciones de ahorro de espacio para la desconexión frecuente de tubos o herramientas neumáticas.

- Compacto y ergonómico
- Fácil identificación de los circuitos
- Fácil desconexión / operación con una sola mano

propio perfil



KF

Sin obturación

Presión de trabajo*:
hasta 20 bar

Material:

- Enchufe: Polímero técnico, latón niquelado
- Acoplador: latón niquelado
- Junta: NBR

Temperatura de trabajo:
-20°C hasta +60°C (NBR)

Caudal de aire:
165 NI/min.
presión de entrada 6 bar, caída de presión 0,6 bar

 Sin obturación

0171 Enchufe sin válvula, rosca macho BSPT

Polímero técnico, latón niquelado, NBR

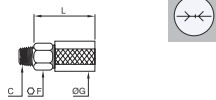

DN	C		F	G	L
R1/8	0171 03 10 01		13	17	24,5
R1/8	0171 03 10 02		13	17	24,5
3	R1/8	0171 03 10 03	13	17	24,5
	R1/8	0171 03 10 04	13	17	24,5
	R1/8	0171 03 10 05	13	17	24,5

Sin obturación

 Sin obturación

0180 Acoplador sin válvula, con conexión para tubo flexible

Latón niquelado

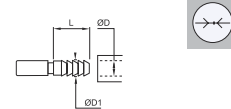

DN	ØD	ØD1		L
3	4	6	0180 04 00	19
	5	6,5	0180 05 00	19

Acoplador sin obturación

0181 Acoplador sin válvula, con conexión para tubo de poliamida (PA)

Latón niquelado

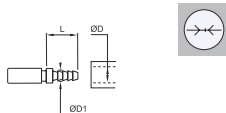

DN	ØD	ØD1		L
3	4	4,7	0181 04 06	19

Acoplador sin obturación

3150 Acoplador sin válvula, con conexión Push-In LF 3000

Latón niquelado, NBR

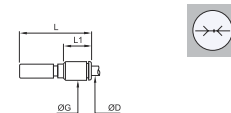

DN	ØD		G	L	L1	
3	4	3150 00 61		8,5	39	18

Acoplador sin obturación

Serie estándar

Diámetro nominal
5

propio perfil



La gama estándar ofrece una solución robusta y un buen compromiso entre el rendimiento del espacio y el del caudal.

- Robusto y adaptado a una aplicación exigente
- Buena resistencia a la corrosión gracias al niquelado

OKA Simple obturación

Presión de trabajo*:
hasta 20 bar

Material:

- Enchufe: Latón niquelado
- Acoplador: Acero blister chapado en zinc
- Junta: NBR

Temperatura de trabajo:
-20°C hasta +80°C (NBR)

Caudal de aire:

480 NI/min.

presión de entrada 6 bar, caída de presión 0,6 bar

Simple obturación

0172 Enchufe con válvula, rosca hembra BSPP

Latón niquelado, NBR



DN	C	E	F	G	L
5	G1/4	11	19	21	47

Serie estándar: simple obturación = 480 NI/min

Simple obturación

0186 Acoplador sin válvula, rosca hembra BSPP

Acero cementado zincado



DN	C	E	F	L
5	G1/4	12	17	17

Acoplador sin obturación

0187 Acoplador sin válvula, rosca BSPP macho

Acero cementado zincado



DN	C	E	F	L
5	G1/8	7	14	4
	G1/4	9,5	17	5

Acoplador sin obturación

0185 Acoplador sin válvula, con conexión de barra para tubo flexible

Acero cementado zincado



DN	ØD	ØD1	L
5	4	6	22,5
	7	9	22,5
	10	12,2	22,5

Acoplador sin obturación

Serie estándar

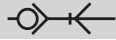

Simple obturación

0189 Enchufe doble

Acero cementado zincado



DN



5 0189 05 00

F L

12 4

Acoplador sin obturación

02 // Enchufes automáticos

Latón / Acero

Serie estándar

Serie 17 - Latón / Acero

Diámetro nominal
5 = 20 mm²



Enchufe automático industrial de latón/acero con perfil británico específicamente adaptado a las aplicaciones de aire comprimido en la industria. Sistema de enchufe automático con accionamiento con una sola mano. Válvula de alto caudal para un flujo óptimo y una baja caída de presión. Versátil gracias a su diseño delgado y su peso ligero.

- Disponible a petición:
 - con conexiones finales adicionales
 - otras juntas para diferentes rangos de temperatura y fluidos

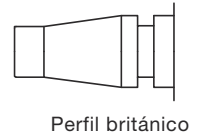

Presión de trabajo*:
hasta 35 bar

Material:

- Enchufe: Latón / acero niquelado
- Acoplador: Acero niquelado
- Junta: NBR

Temperatura de trabajo:
-20°C hasta +100°C (NBR)

Caudal de aire:
890 l/min.
presión de entrada 6 bar, caída de presión 0,5 bar

Caudal de agua:

11 l/min.
caída de presión de 0,5 bar

* máxima presión estática de trabajo con un factor de diseño de 4 a 1.

 Simple obturación

17KAAK Enchufe con válvula, rosca macho

Latón/acero niquelado, NBR

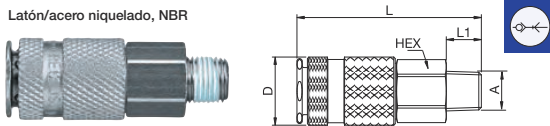

A			HEX	L	L1	D
R1/4	17KAAK13SPN	9105 17 13	19	63	12	23
R3/8	17KAAK17SPN		19	62	12	23
R1/2	17KAAK21SPN	9105 17 21	22	63	17	23

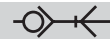
 Simple obturación

17KATF Enchufe con válvula, conexión manguera

Latón/acero niquelado, NBR

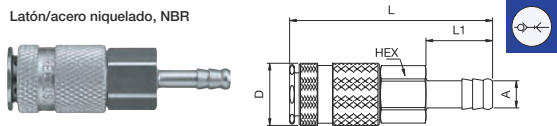

A			HEX	L	L1	D
6	17KATF06SPN		19	76	25	23
8	17KATF08SPN		19	76	25	23
10	17KATF10SPN		19	76	25	23
13	17KATF13SPN		19	76	25	23

17KAIW Enchufe con válvula, rosca hembra

Latón/acero niquelado, NBR

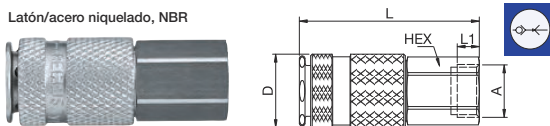

A			HEX	L	L1	D
G1/4	17KAIW13SPN	9114 17 13	19	58	9	23
G3/8	17KAIW17SPN	9114 17 17	19	57	9	23
G1/2	17KAIW21SPN	9114 17 21	24	60	12	23

Serie 17 - Latón / Acero

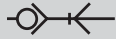

Simple obturación

17SFAK Acoplador sin válvula, rosca macho

Acero niquelado

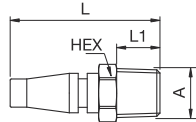

A	HEX	L	L1
R1/8 17SFAK10SXN	11	37	9
R1/4 17SFAK13SXN	14	42	12

17SFIW Acoplador sin válvula, rosca hembra

Acero niquelado

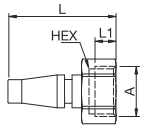

A	HEX	L	L1
G1/8 17SFIW10SXN	14	33	7
G1/4 17SFIW13SXN	17	36	9

17SFTF Acoplador sin válvula, conexión manguera

Acero niquelado

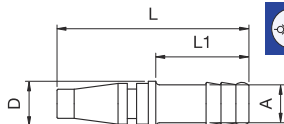

A	L	L1	D
6 17SFTF06SXN	58	25	12
8 17SFTF08SXN	52	25	12
10 17SFTF10SXN	52	25	12

Serie 21 - Latón / Acero

Diámetro nominal
5 = 20 mm²



Mini industrial acoplado con el perfil más popular del mundo en este Diámetro nominal. Rendimiento de flujo superior al promedio para medios líquidos y gaseosos. Sistema de enchufe automático con operación de una sola mano. Pequeñas dimensiones y gran ancho de banda en materiales y variantes de válvulas.

- Disponible a petición:
 - con conexiones finales adicionales
 - otras juntas para diferentes rangos de temperatura y fluidos

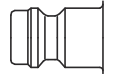

Perfil de Euro

Protecciones contra el polvo (P. 357)
para acoplar la pieza.-No. SK16S



Simple obturación

Presión de trabajo*:
hasta 35 bar

Material:

- Enchufe: Latón
- Acoplador: Latón
- Junta: NBR

Temperatura de trabajo:
-20°C hasta +100°C (NBR)

Caudal de aire:

550 l/min.
presión de entrada 6 bar, caída de presión 0,5 bar

Caudal de agua:

7 l/min.
caída de presión de 0,5 bar



Doble obturación

Presión de trabajo*:
hasta 35 bar

Material:

- Enchufe: Latón
- Acoplador: Latón
- Junta: NBR

Temperatura de trabajo:
-20°C hasta +100°C (NBR)

Caudal de aire:

310 l/min.
presión de entrada 6 bar, caída de presión 0,5 bar

Caudal de agua:

2,7 l/min.
caída de presión de 0,5 bar



Doble obturación sin goteo

Presión de trabajo*:
hasta 8 bar

Material:

- Enchufe: Latón
- Acoplador: Latón
- Junta: NBR

Temperatura de trabajo:
-20°C hasta +100°C (NBR)

Caudal de agua:

2,7 l/min.
caída de presión de 0,5 bar

* máxima presión estática de trabajo con un factor de diseño de 4 a 1.



Simple obturación

21KAA Enchufe con válvula, rosca macho

Latón, NBR

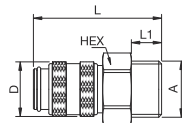

A	HEX	L	L1	D	Versión	
G1/8	21KAAW10MPX	14	36	7	16	Latón
	21KAAW10MPN	14	36	7	16	Latón niquelado
G1/4	21KAAW13MPX	17	38	9	16	Latón
	21KAAW13MPN	17	38	9	16	Latón niquelado
G3/8	21KAAW17MPX	19	38	9	16	Latón
	21KAAW17MPN	19	38	9	16	Latón niquelado
M10 x 1	21KAAD10MPX	14	37	8	16	Latón
	21KAAD10MPN	14	37	8	16	Latón niquelado
M12 x 1,5	21KAAD12MPX	17	39	10	16	Latón
	21KAAD12MPN	17	39	10	16	Latón niquelado
M14 x 1,5	21KAAD14MPX	17	39	10	16	Latón
	21KAAD14MPN	17	39	10	16	Latón niquelado



Simple obturación

21KAI Enchufe con válvula, rosca hembra

Latón, NBR

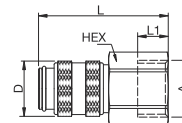

A	HEX	L	L1	D	Versión	
G1/8	21KAIW10MPX	14	36	9	16	Latón
	21KAIW10MPN	14	36	9	16	Latón niquelado
G1/4	21KAIW13MPX	17	38	9	16	Latón
	21KAIW13MPN	17	38	9	16	Latón niquelado
G3/8	21KAIW17MPX	19	38	9	16	Latón
	21KAIW17MPN	19	38	9	16	Latón niquelado
M12 x 1,5	21KAIM12MPX	17	38	6	16	Latón
	21KAIM12MPN	17	38	6	16	Latón niquelado
M14 x 1,5	21KAIM14MPX	17	38	6	16	Latón
	21KAIM14MPN	17	38	6	16	Latón niquelado

Serie 21 - Latón / Acero



Simple obturación

21KATF Enchufe con válvula, conexión manguera

Latón, NBR

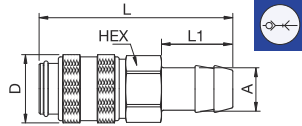
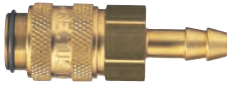

A		HEX	L	L1	D	Versión
4	21KATF04MPX	14	46	17	16	Latón
	21KATF04MPN	14	46	17	16	Latón niquelado
5	21KATF05MPX	14	46	17	16	Latón
	21KATF05MPN	14	46	17	16	Latón niquelado
6	21KATF06MPX	14	46	17	16	Latón
	21KATF06MPN	14	46	17	16	Latón niquelado
8	21KATF08MPX	14	46	17	16	Latón
	21KATF08MPN	14	46	17	16	Latón niquelado
9	21KATF09MPX	14	46	17	16	Latón
	21KATF09MPN	14	46	17	16	Latón niquelado
10	21KATF10MPX	14	46	17	16	Latón
	21KATF10MPN	14	46	17	16	Latón niquelado



Simple obturación

21KATS Enchufe con válvula, montaje en panel con manguera

Latón, NBR

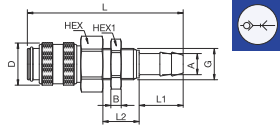

A		HEX	HEX1	B	G	L	L1	L2	D	Versión
4	21KATS04MPX	12	12	4	M10x1	60	17	14	16	Latón
	21KATS04MPN	12	12	4	M10x1	60	17	14	16	Latón niquelado
5	21KATS05MPX	17	17	4	M12x1	60	17	14	16	Latón
	21KATS05MPN	17	17	4	M12x1	60	17	14	16	Latón niquelado
6	21KATS06MPX	17	17	4	M12x1	60	17	14	16	Latón
	21KATS06MPN	17	17	4	M12x1	60	17	14	16	Latón niquelado
8	21KATS08MPX	17	17	4	M12x1	60	17	14	16	Latón
	21KATS08MPN	17	17	4	M12x1	60	17	14	16	Latón niquelado
9	21KATS09MPX	17	19	4	M14x1	60	17	14	16	Latón
	21KATS09MPN	17	19	4	M14x1	60	17	14	16	Latón niquelado
10	21KATS10MPX	17	19	4	M14x1	60	17	14	16	Latón
	21KATS10MPN	17	19	4	M14x1	60	17	14	16	Latón niquelado

21KAKO Enchufe con válvula, con conexión de manguera de plástico

Latón, NBR

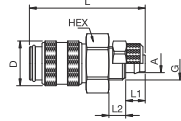

A		HEX	G	L	L1	L2	D	Versión
4 x 6	21KAKO06MPX	14	M10x1	42	7	6	16	Latón
	21KAKO06MPN	14	M10x1	42	7	6	16	Latón niquelado
6 x 8	21KAKO08MPX	14	M12x1	42	7	6	16	Latón
	21KAKO08MPN	14	M12x1	42	7	6	16	Latón niquelado

21KAKK Enchufe con válvula, conexión de manguera plástica con protector de resorte

Latón, NBR

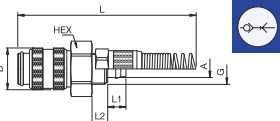

A		HEX	G	L	L1	L2	D	Versión
4 x 6	21KAKK06MPX	14	M10x1	125	7	6	16	Latón
	21KAKK06MPN	14	M10x1	125	7	6	16	Latón niquelado
6 x 8	21KAKK08MPX	14	M10x1	130	7	6	16	Latón
	21KAKK08MPN	14	M10x1	130	7	6	16	Latón niquelado

21KAKS Enchufe con válvula, montaje en panel con conexión de manguera plástica

Latón, NBR

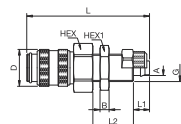

A		HEX	HEX1	B	G	L	L1	L2	D	Versión
4 x 6	21KAKS06MPX	14	12	3	M10x1	54	7	18	16	Latón
	21KAKS06MPN	14	12	3	M10x1	54	7	18	16	Latón niquelado
6 x 8	21KAKS08MPX	17	17	4	M12x1	54	7	18	16	Latón
	21KAKS08MPN	17	17	4	M12x1	54	7	18	16	Latón niquelado

21KARP Enchufe con válvula, Push-In

Latón niquelado, NBR

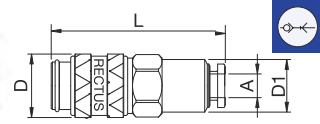

A		HEX	L	D	D1
6	21KARP06MPN	14	43,5	16	13,3
8	21KARP08MPN	17	48	16	15,3

Serie 21 - Latón / Acero



Simple obturación

21SFA Acoplador sin válvula, rosca macho

Latón

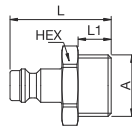
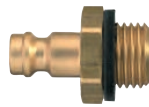

A			HEX	L	L1	Versión
G1/8	21SFAW10MXX		14	25	7	Latón
	21SFAW10MXN	9087 21 10	14	25	7	Latón niquelado
G1/4	21SFAW13MXX		17	28	9	Latón
	21SFAW13MXN	9087 21 13	17	28	9	Latón niquelado
G3/8	21SFAW17MXX		19	28	9	Latón
	21SFAW17MXN		19	28	9	Latón niquelado
M10 x 1	21SFAD10MXX		14	26	8	Latón
	21SFAD10MXN		14	26	8	Latón niquelado
M12 x 1,5	21SFAD12MXX		17	28	10	Latón
	21SFAD12MXN		17	28	10	Latón niquelado
M14 x 1,5	21SFAD14MXX		17	28	10	Latón
	21SFAD14MXN		17	28	10	Latón niquelado

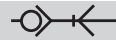

Simple obturación

21SFTF Acoplador sin válvula, conexión manguera

Latón

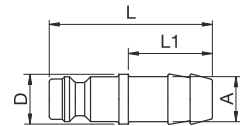
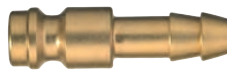

A			L	L1	D	Versión
4	21SFTF04MXX		32	17	9	Latón
	21SFTF04MXN	9085 21 04	32	17	9	Latón niquelado
5	21SFTF05MXX		32	17	9	Latón
	21SFTF05MXN		32	17	9	Latón niquelado
6	21SFTF06MXX		32	17	9	Latón
	21SFTF06MXN	9085 21 06	32	17	9	Latón niquelado
8	21SFTF08MXX		32	17	9	Latón
	21SFTF08MXN	9085 21 08	32	17	9	Latón niquelado
9	21SFTF09MXX		33	17	10	Latón
	21SFTF09MXN		33	17	10	Latón niquelado
10	21SFTF10MXX		33	17	12	Latón
	21SFTF10MXN		33	17	12	Latón niquelado

21SFI Acoplador sin válvula, rosca hembra

Latón

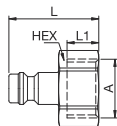

A			HEX	L	L1	Versión
G1/8	21SFIW10MXX		14	25	8	Latón
	21SFIW10MXN	9086 21 10	14	25	8	Latón niquelado
G1/4	21SFIW13MXX		17	25	9	Latón
	21SFIW13MXN	9086 21 13	17	25	9	Latón niquelado
G3/8	21SFIW17MXX		19	26	9	Latón
	21SFIW17MXN		19	26	9	Latón niquelado
M12 x 1,5	21SFIM12MXX		17	27	10	Latón
	21SFIM12MXN		17	27	10	Latón niquelado
M14 x 1,5	21SFIM14MXX		17	27	10	Latón
	21SFIM14MXN		17	27	10	Latón niquelado

21SFKO Acoplador sin válvula, conexión manguera de plástico

Latón

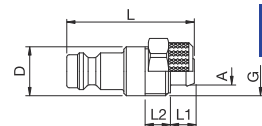
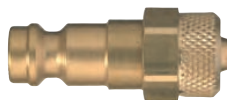

A		G	L	L1	L2	D	Versión
4 x 6	21SFKO06MXX	M10x1	32	6	6	10	Latón
	21SFKO06MXN	M10x1	32	6	6	10	Latón niquelado
6 x 8	21SFKO08MXX	M12x1	32	6	6	12	Latón
	21SFKO08MXN	M12x1	32	6	6	12	Latón niquelado

21SFKS Acoplador sin válvula, montaje en panel con conexión de manguera de plástico

Latón

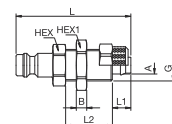
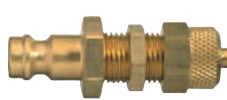

A		HEX	HEX1	B	G	L	L1	L2	Versión
4 x 6	21SFKS06MXX	14	12	3	M10x1	43	7	18	Latón
	21SFKS06MXN	14	12	3	M10x1	43	7	18	Latón niquelado
6 x 8	21SFKS08MXX	14	17	4	M12x1	44	7	18	Latón
	21SFKS08MXN	14	17	4	M12x1	44	7	18	Latón niquelado

Serie 21 - Latón / Acero

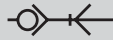

Simple obturación

21SFTS Acoplador sin válvula, montaje en panel con manguera

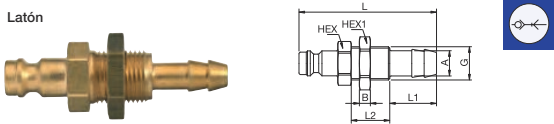

A	HEX	HEX1	B	G	L	L1	L2	Versión
4	14	14	3	M10x1	50	17	14	Latón
	14	14	3	M10x1	50	17	14	Latón niquelado
5	14	17	4	M12x1	50	17	14	Latón
	14	17	4	M12x1	50	17	14	Latón niquelado
6	14	17	4	M12x1	50	17	14	Latón
	14	17	4	M12x1	50	17	14	Latón niquelado
8	14	17	4	M12x1	50	17	14	Latón
	14	17	4	M12x1	50	17	14	Latón niquelado

21SFKK Acoplador sin válvula, conexión de manguera de plástico con protector de resorte

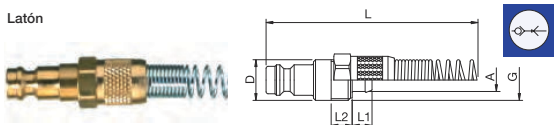

A	G	L	L1	L2	D	Versión
4 x 6	M10x1	115	6	6	10	Latón
	M10x1	115	6	6	10	Latón niquelado
6 x 8	M12x1	120	6	6	12	Latón
	M12x1	120	6	6	12	Latón niquelado

21SFRP Acoplador sin válvula, Push-In

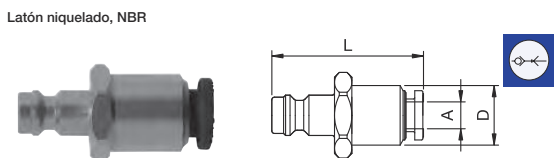

A	HEX	L	D
6	14	30,5	13,3
8	17	37	15,3



Doble obturación

21KBA Enchufe con válvula, rosca macho

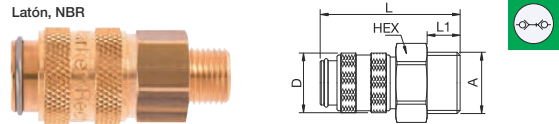

A	HEX	L	L1	D	Versión
G1/8	14	36	7	16	Latón
	14	36	7	16	Latón niquelado
G1/4	17	38	9	16	Latón
	17	38	9	16	Latón niquelado
G3/8	19	38	9	16	Latón
	19	38	9	16	Latón niquelado
M10 x 1	14	37	8	16	Latón
	14	37	8	16	Latón niquelado
M12 x 1,5	17	39	10	16	Latón
	17	39	10	16	Latón niquelado
M14 x 1,5	17	39	10	16	Latón
	17	39	10	16	Latón niquelado

21KBI Enchufe con válvula, rosca hembra

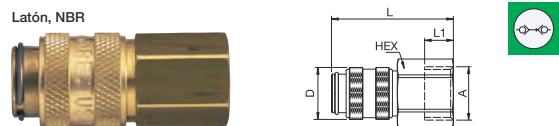

A	HEX	L	L1	D	Versión
G1/8	14	36	9	16	Latón
	14	36	9	16	Latón niquelado
G1/4	17	38	9	16	Latón
	17	38	9	16	Latón niquelado
G3/8	19	38	9	16	Latón
	19	38	9	16	Latón niquelado
M12 x 1,5	17	38	6	16	Latón
	17	38	6	16	Latón niquelado
M14 x 1,5	17	38	6	16	Latón
	17	38	6	16	Latón niquelado

Serie 21 - Latón / Acero

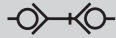

Doble obturación

21KBT F Enchufe con válvula, conexión manguera

Latón, NBR

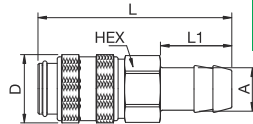
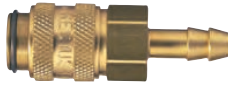

A		HEX	L	L1	D	Versión
4	21KBT F04MPX	14	46	17	16	Latón
	21KBT F04MPN 9223 21 04	14	46	17	16	Latón niquelado
5	21KBT F05MPX	14	46	17	16	Latón
	21KBT F05MPN	14	46	17	16	Latón niquelado
6	21KBT F06MPX	14	46	17	16	Latón
	21KBT F06MPN 9223 21 06	14	46	17	16	Latón niquelado
8	21KBT F08MPX	14	46	17	16	Latón
	21KBT F08MPN 9223 21 08	14	46	17	16	Latón niquelado
9	21KBT F09MPX	14	46	17	16	Latón
	21KBT F09MPN	14	46	17	16	Latón niquelado
10	21KBT F10MPX	14	46	17	16	Latón
	21KBT F10MPN	14	46	17	16	Latón niquelado

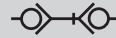

Doble obturación

21KBT S Enchufe con válvula, montaje en panel con manguera

Latón, NBR

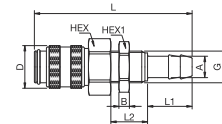

A		HEX	HEX1	B	G	L	L1	L2	D	Versión
4	21KBT S04MPX	14	14	3	M10x1	60	17	14	16	Latón
	21KBT S04MPN 9226 21 04	14	14	3	M10x1	60	17	14	16	Latón niquelado
5	21KBT S05MPX	17	17	4	M12x1	60	17	14	16	Latón
	21KBT S05MPN	17	17	4	M12x1	60	17	14	16	Latón niquelado
6	21KBT S06MPX	17	17	4	M12x1	60	17	14	16	Latón
	21KBT S06MPN 9226 21 06	17	17	4	M12x1	60	17	14	16	Latón niquelado
8	21KBT S08MPX	17	17	4	M12x1	60	17	14	16	Latón
	21KBT S08MPN 9226 21 08	17	17	4	M12x1	60	17	14	16	Latón niquelado
9	21KBT S09MPX	17	19	4	M12x1	60	17	14	16	Latón
	21KBT S09MPN	17	19	4	M12x1	60	17	14	16	Latón niquelado
10	21KBT S10MPX	17	19	4	M14x1	60	17	14	16	Latón
	21KBT S10MPN	17	19	4	M14x1	60	17	14	16	Latón niquelado

21KBK O Enchufe con válvula, con conexión de manguera de plástico

Latón, NBR

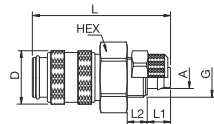

A		HEX	G	L	L1	L2	D	Versión
4 x 6	21KBK O06MPX	14	M10x1	42	7	6	16	Latón
	21KBK O06MPN	14	M10x1	42	7	6	16	Latón niquelado
6 x 8	21KBK O08MPX	14	M12x1	42	7	6	16	Latón
	21KBK O08MPN	14	M12x1	42	7	6	16	Latón niquelado

21KBK K Enchufe con válvula, conexión de manguera plástica con protector de resorte

Latón, NBR

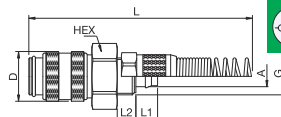

A		HEX	G	L	L1	L2	D	Versión
4 x 6	21KBK K06MPX	14	M10x1	125	7	6	16	Latón
	21KBK K06MPN	14	M10x1	125	7	6	16	Latón niquelado
M12 x 1	21KBK K08MPX	14	M10x1	130	7	6	16	Latón
	21KBK K08MPN	14	M10x1	130	7	6	16	Latón niquelado

21KBK S Enchufe con válvula, montaje en panel con conexión de manguera plástica

Latón, NBR

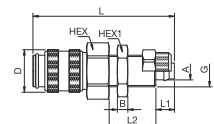

A		HEX	HEX1	B	G	L	L1	L2	D	Versión
4 x 6	21KBK S06MPX	14	12	3	M10x1	54	7	18	16	Latón
	21KBK S06MPN	14	12	3	M10x1	54	7	18	16	Latón niquelado
6 x 8	21KBK S08MPX	17	17	4	M12x1	54	7	18	16	Latón
	21KBK S08MPN	17	17	4	M12x1	54	7	18	16	Latón niquelado

21KBR P Enchufe con válvula, Push-In

Latón niquelado, NBR

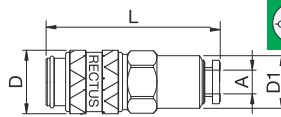

A		HEX	L	D	D1
6	21KBR P06MPN	14	43,5	16	13,3
8	21KBR P08MPN	17	48	16	15,3

Serie 21 - Latón / Acero

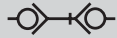

Doble obturación

21SBA Acoplador con válvula, rosca macho

Latón, NBR

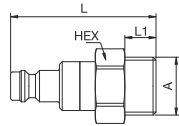
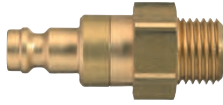

A			HEX	L	L1	Versión
G1/8	21SBAW10MPX		14	40	7	Latón
	21SBAW10MPN	9287 21 10	14	40	7	Latón niquelado
G1/4	21SBAW13MPX		17	42	9	Latón
	21SBAW13MPN	9287 21 13	17	42	9	Latón niquelado
G3/8	21SBAW17MPX		19	42	9	Latón
	21SBAW17MPN		19	42	9	Latón niquelado
M10 x 1	21SBAD10MPX		14	41	8	Latón
	21SBAD10MPN		14	41	8	Latón niquelado
M12 x 1,5	21SBAD12MPX		17	43	10	Latón
	21SBAD12MPN		17	43	10	Latón niquelado
M14 x 1,5	21SBAD14MPX		17	43	10	Latón
	21SBAD14MPN		17	43	10	Latón niquelado

21SBI Acoplador con válvula, rosca hembra

Latón, NBR

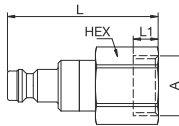
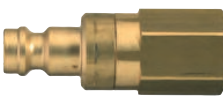

A			HEX	L	L1	Versión
G1/8	21SBIW10MPX		14	40	7	Latón
	21SBIW10MPN	9286 21 10	14	40	7	Latón niquelado
G1/4	21SBIW13MPX		17	42	7	Latón
	21SBIW13MPN	9286 21 13	17	42	7	Latón niquelado
G3/8	21SBIW17MPX		19	42	7	Latón
	21SBIW17MPN		19	42	7	Latón niquelado
M12 x 1,5	21SBIM12MPX		17	42	7	Latón
	21SBIM12MPN		17	42	7	Latón niquelado
M14 x 1,5	21SBIM14MPX		17	42	7	Latón
	21SBIM14MPN		17	42	7	Latón niquelado

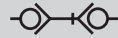

Doble obturación

21SBTF Acoplador con válvula, conexión manguera

Latón, NBR

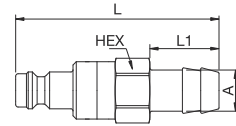
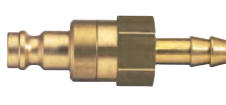

A			HEX	L	L1	Versión
4	21SBTF04MPX		14	50	17	Latón
	21SBTF04MPN	9285 21 04	14	50	17	Latón niquelado
5	21SBTF05MPX		14	50	17	Latón
	21SBTF05MPN		14	50	17	Latón niquelado
6	21SBTF06MPX		14	50	17	Latón
	21SBTF06MPN	9285 21 06	14	50	17	Latón niquelado
8	21SBTF08MPX		14	50	17	Latón
	21SBTF08MPN	9285 21 08	14	50	17	Latón niquelado
9	21SBTF09MPX		14	50	17	Latón
	21SBTF09MPN		14	50	17	Latón niquelado
10	21SBTF10MPX		14	50	17	Latón
	21SBTF10MPN		14	50	17	Latón niquelado

21SBKO Acoplador con válvula, con conexión de manguera de plástico

Latón, NBR

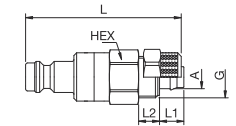

A		HEX	G	L	L1	L2	Versión
4 x 6	21SBKO06MPX	14	M10x1	46	7	6	Latón
	21SBKO06MPN	14	M10x1	46	7	6	Latón niquelado
6 x 8	21SBKO08MPX	14	M12x1	46	7	6	Latón
	21SBKO08MPN	14	M12x1	46	7	6	Latón niquelado

21SBKS Acoplador con válvula, montaje en panel con conexión de manguera plástica

Latón, NBR

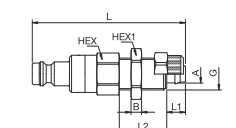

A		HEX	HEX1	B	G	L	L1	L2	Versión
4 x 6	21SBKS06MPX	14	12	3	M10x1	58	7	18	Latón
	21SBKS06MPN	14	12	3	M10x1	58	7	18	Latón niquelado
6 x 8	21SBKS08MPX	17	17	4	M12x1	58	7	18	Latón
	21SBKS08MPN	17	17	4	M12x1	58	7	18	Latón niquelado

Serie 21 - Latón / Acero



Doble obturación

21SBTS Acoplador con válvula, montaje en panel con manguera

Latón, NBR

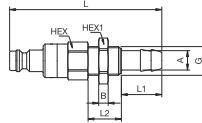
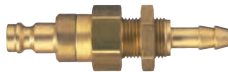

A	Imagen	HEX	HEX1	B	G	L	L1	L2	Versión
4		14	14	3	M10x1	64	17	14	Latón
		14	14	3	M10x1	64	17	14	Latón niquelado
5		14	14	4	M10x1	64	17	14	Latón niquelado
		14	14	4	M10x1	64	17	14	Latón niquelado
6		14	17	4	M12x1	64	17	14	Latón
		14	17	4	M12x1	64	17	14	Latón niquelado
8		14	17	4	M12x1	64	17	14	Latón
		14	17	4	M12x1	64	17	14	Latón niquelado
9		14	17	4	M12x1	64	17	14	Latón
		14	17	4	M12x1	64	17	14	Latón niquelado
10		14	19	4	M14x1	64	17	14	Latón
		14	19	4	M14x1	64	17	14	Latón niquelado

21SBKK Acoplador con válvula, conexión manguera plástico muelle protector

Latón, NBR

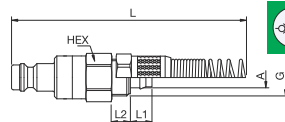

A	Imagen	HEX	G	L	L1	L2	Versión
4 x 6		14	M10x1	130	7	6	Latón
		14	M10x1	130	7	6	Latón niquelado
6 x 8		14	M12x1	135	7	6	Latón
		14	M12x1	135	7	6	Latón niquelado

21SBRP Acoplador con válvula, Push-In

Latón niquelado, NBR

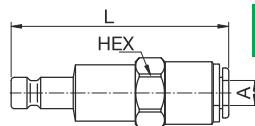

A	Imagen	HEX	L
4 x 6		14	47,5
6 x 8		17	47,5



Sin goteo

21KLAW Enchufe con válvula, rosca macho

Latón niquelado, NBR

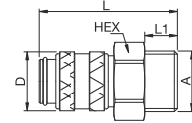

A	Imagen	HEX	L	L1	D
G1/8		14	36	7	16
G1/4		17	38	9	16
G3/8		19	38	9	16

21KLIW Enchufe con válvula, rosca hembra

Latón niquelado, NBR

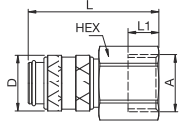

A	Imagen	HEX	L	L1	D
G1/8		14	36	9	16
G1/4		17	38	9	16
G3/8		19	38	9	16

21KLTF Enchufe con válvula, conexión manguera

Latón niquelado, NBR

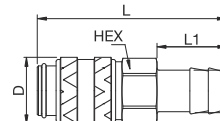

A	Imagen	HEX	L	L1	D
4		14	46	17	16
6		14	46	17	16
8		14	46	17	16
9		14	46	17	16
10		14	46	17	16

21KLKO Enchufe con válvula, con conexión de manguera de plástico

Latón niquelado, NBR

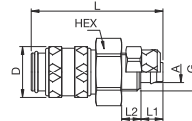

A	Imagen	HEX	G	L	L1	L2	D
4 x 6		14	M10x1	42	7	6	16
6 x 8		14	M12x1	42	7	6	16

Serie 21 - Latón / Acero



Sin goteo

21KLKS Enchufe con válvula, montaje en panel con conexión de manguera plástica

Latón niquelado, NBR

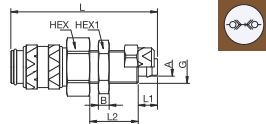

A	HEX	HEX1	B	G	L	L1	L2	D	
4 x 6	21KLKS06MPN	14	14	3	M10x1	54	7	18	16
6 x 8	21KLKS08MPN	17	17	4	M12x1	54	7	18	16

21KLTS Enchufe con válvula, montaje en panel con manguera

Latón niquelado, NBR

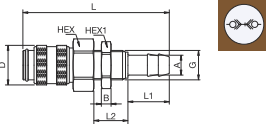

A	HEX	HEX1	B	G	L	L1	L2	D	
5	21KLTS05MPN	17	17	4	M12x1	60	17	14	16
6	21KLTS06MPN	17	17	4	M12x1	60	17	14	16

21KLKK Enchufe con válvula, conexión de manguera plástica con muelle protector

Latón niquelado, NBR

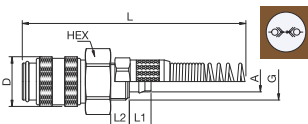

A	HEX	G	L	L1	L2	D	
4 x 6	21KLKK06MPN	14	M10x1	125	7	6	16
6 x 8	21KLKK08MPN	14	M10x1	130	7	6	16

21SLAW Acoplador con válvula, rosca macho

Latón niquelado, NBR

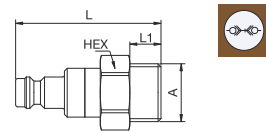

A	HEX	L	L1	
G1/8	21SLAW10MPN	14	40	7
G1/4	21SLAW13MPN	17	42	9
G3/8	21SLAW17MPN	19	42	9



Sin goteo

21SLIW Acoplador con válvula, rosca hembra

Latón niquelado, NBR

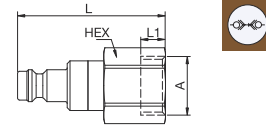

A	HEX	L	L1	
G1/8	21SLIW10MPN	14	40	7
G1/4	21SLIW13MPN	17	42	7
G3/8	21SLIW17MPN	19	42	7

21SLTF Acoplador con válvula, conexión manguera

Latón niquelado, NBR

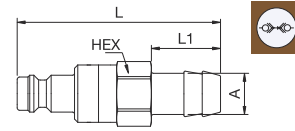

A	HEX	L	L1	
4	21SLTF04MPN	14	50	17
6	21SLTF06MPN	14	50	17
8	21SLTF08MPN	14	50	17
9	21SLTF09MPN	14	50	17
10	21SLTF10MPN	14	50	17

21SLKO Acoplador con válvula, con conexión de manguera de plástico

Latón niquelado, NBR

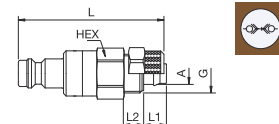

A	HEX	G	L	L1	L2	
4 x 6	21SLKO06MPN	14	M10x1	46	7	6
6 x 8	21SLKO08MPN	14	M12x1	46	7	6

21SLKS Acoplador con válvula, montaje en panel con conexión de manguera plástica

Latón niquelado, NBR

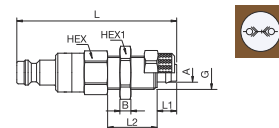

A	HEX	HEX1	B	G	L	L1	L2	
4 x 6	21SLKS06MPN	14	12	3	M10x1	58	7	18
6 x 8	21SLKS08MPN	14	17	4	M12x1	58	7	18

Serie 21 - Latón / Acero



Sin goteo

21SLTS Acoplador con válvula, montaje en panel con manguera

Latón niquelado, NBR

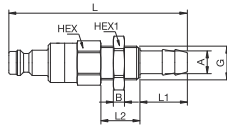

A		HEX	HEX1	B	G	L	L1	L2
5	 21SLTS05MPN	14	14	4	M12x1	64	17	14
6	 21SLTS06MPN	14	17	4	M12x1	64	17	14

21SLKK Acoplador con válvula, conexión de manguera plástica con muelle protector

Latón niquelado, NBR

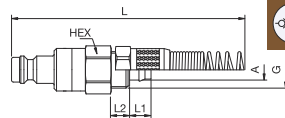

A		HEX	G	L	L1	L2
4 x 6	 21SLKK06MPN	14	M10x1	130	7	6
6 x 8	 21SLKK08MPN	14	M12x1	135	7	6

Serie 14 - Latón / Acero

Diámetro nominal
5,5 = 24 mm²



Enchufe automático robusto de latón con numerosas opciones de conexión. La aplicación preferida es la tecnología de aire comprimido. También es especialmente adecuado para el uso con agua debido a la válvula de latón. Sistema de enchufe automático con manejo con una sola mano. Diseño de enchufe optimizado gracias a una mayor profundidad de inserción.

- Disponible a petición:
 - en material de latón con recubrimiento de níquel
 - con conexiones finales adicionales
 - otras juntas para diferentes rangos de temperatura y fluidos

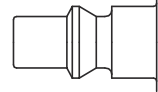

Perfil de ARO



Simple obturación

Presión de trabajo*:
hasta 35 bar

Material:

- Enchufe: Latón
- Acoplador: Latón
- Junta: NBR

Temperatura de trabajo:
-20°C hasta +100°C (NBR)

Caudal de aire:

660 l/min.
presión de entrada 6 bar, caída de presión 0,5 bar

Caudal de agua:

9,1 l/min.
caída de presión de 0,5 bar

* máxima presión estática de trabajo con un factor de diseño de 4 a 1.



Simple obturación

14KAAW Enchufe con válvula, rosca macho

Latón, NBR

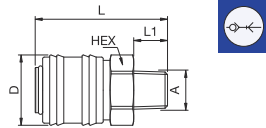

A	HEX	L	L1	D
G1/4	14KAAW13MPX	22	43	9 25
G3/8	14KAAW17MPX	22	43	9 25
G1/2	14KAAW21MPX	22	46	12 25



Simple obturación

14KATF Enchufe con válvula, conexión manguera

Latón, NBR

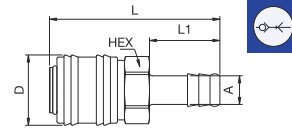
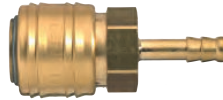

A	HEX	L	L1	D
6	14KATF06MPX	21	60	25 25
8	14KATF08MPX	21	60	25 25
9	14KATF09MPX	21	60	25 25
10	14KATF10MPX	21	60	25 25
13	14KATF13MPX	21	60	25 25

14KAIW Enchufe con válvula, rosca hembra

Latón, NBR

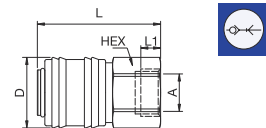

A	HEX	L	L1	D
G1/4	14KAIW13MPX	22	43	9 25
G3/8	14KAIW17MPX	22	43	9 25
G1/2	14KAIW21MPX	24	46	12 25

Serie 14 - Latón / Acero



Simple obturación

22SFA Acoplador sin válvula, rosca macho

Acero o latón niquelado

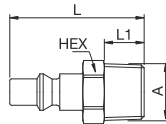

A			HEX	L	L1	Versión
R1/8			12	35	9	Acero niquelado
			14	41	12	Acero niquelado
R1/4		9084 22 13	14	41	12	Latón
G1/4		22SFAW13MXX	14	41	12	Latón
R3/8		22SFAK17SXN	17	41	12	Acero niquelado
G3/8		22SFAW17MXX	17	41	12	Latón
R1/2		22SFAK21SXN	22	46	17	Acero niquelado
G1/2		22SFAW21MXX	22	46	17	Latón

22SFIW Acoplador sin válvula, rosca hembra

Acero o latón niquelado

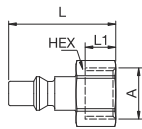
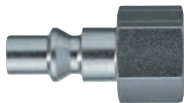

A			HEX	L	L1	Versión
G1/4			17	35	9	Acero niquelado
G1/4		22SFIW13MXX	17	35	9	Latón
G3/8		22SFIW17SXN	19	35	10	Acero niquelado
G1/2		22SFIW21SXN	24	35	12	Acero niquelado

22SFTF Acoplador sin válvula, conexión manguera

Acero o latón niquelado

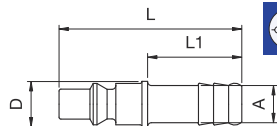

A			L	L1	D	Versión
6			49	25	12	Acero niquelado
		22SFTF06MXX	49	25	12	Latón
8		22SFTF08SXN	49	25	12	Acero niquelado
9		22SFTF09SXN	49	25	12	Acero niquelado
10		22SFTF10SXN	49	25	12	Acero niquelado
10		22SFTF10MXX	49	25	12	Latón
13		22SFTF13SXN	49	25	15	Acero niquelado

Serie 18 - Latón / Acero

Diámetro nominal
5,5 = 25 mm²



Enchufe automático industrial robusto según la norma ISO 6150 C. Sistema de enchufe automático con una sola mano. Válvula de alto caudal para un flujo óptimo y una baja caída de presión. El manguito de acero contrarresta las fuerzas oscilantes. El sistema tiene un uso limitado para los líquidos (manguito de acero/válvula de zinc fundido a presión). La alta profundidad de inserción está garantizada por una guía de enchufe optimizada.

- Disponible a petición:
 - con conexiones finales adicionales
 - otras juntas para diferentes rangos de temperatura y fluidos

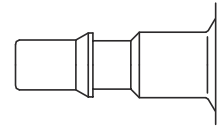

Perfil ISO 6150 C

Protecciones contra el polvo (P. 357) para acoplar la pieza.-No. SK23S



Presión de trabajo*:
hasta 35 bar

Material:

- Enchufe: Latón / acero niquelado
- Acoplador: Acero niquelado
- Junta: NBR

Temperatura de trabajo:
-20°C hasta +100°C (NBR)

Caudal de aire:

970 l/min.
presión de entrada 6 bar, caída de presión 0,5 bar

Caudal de agua:

12,7 l/min.
caída de presión de 0,5 bar

* máxima presión estática de trabajo con un factor de diseño de 4 a 1.

 Simple obturación

18KAAK Enchufe con válvula, rosca macho

Latón/acero niquelado, NBR

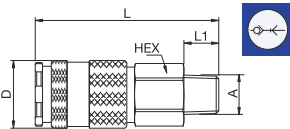
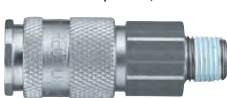

A	HEX	L	L1	D
R1/4	18KAAK13MPN	19	63	12 23
R3/8	18KAAK17MPN	19	62	12 23
R1/2	18KAAK21MPN	22	63	17 23

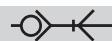
 Simple obturación

18KATF Enchufe con válvula, conexión manguera

Latón/acero niquelado, NBR

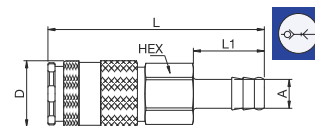
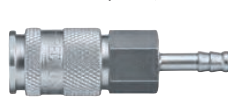

A	HEX	L	L1	D
6	18KATF06MPN	9123 18 06	19	76 25 23
8	18KATF08MPN	9123 18 08	19	76 25 23
10	18KATF10MPN	9123 18 10	19	76 25 23
13	18KATF13MPN		19	76 25 23

18KAIW Enchufe con válvula, rosca hembra

Latón/acero niquelado, NBR

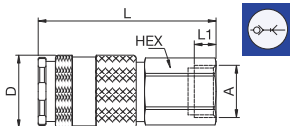

A	HEX	L	L1	D
G1/4	18KAIW13MPN	9114 18 13	19	58 9 23
G3/8	18KAIW17MPN	9114 18 17	19	57 9 23
G1/2	18KAIW21MPN		24	60 12 23

Serie 18 - Latón / Acero

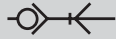

Simple obturación

18SFAW Acoplador sin válvula, rosca macho

Acero niquelado

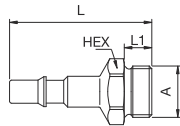

A			HEX	L	L1
G1/4	18SFAW13SXN	9087 18 13	17	41	9
G3/8	18SFAW17SXN	9087 18 17	19	41	9

18SFIW Acoplador sin válvula, rosca hembra

Acero niquelado

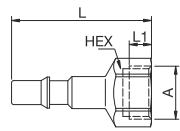

A			HEX	L	L1
G1/4	18SFIW13SXN	9086 18 13	17	43	9
G3/8	18SFIW17SXN	9086 18 17	19	44	9

18SFTF Acoplador sin válvula, conexión manguera

Acero niquelado

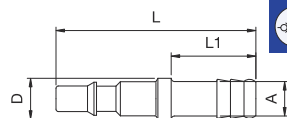

A			L	L1	D
6	18SFTF06SXN	9085 18 06	59	25	12
8	18SFTF08SXN	9085 18 08	59	25	12
10	18SFTF10SXN	9085 18 10	59	25	12

Serie 19 - Latón / Acero

Diámetro nominal
5,5 = 25 mm²



Perfil industrial británico. Sistema de enchufe automático con una sola mano. Válvula de alto caudal para un flujo óptimo y una baja caída de presión. Enchufe automático robusto de diseño delgado, principalmente para aplicaciones neumáticas. El manguito de acero contrarresta las fuerzas oscilantes. La alta profundidad de inserción está garantizada por una guía de enchufe optimizada.

- Disponible a petición:
 - con conexiones finales adicionales
 - otras juntas para diferentes rangos de temperatura y fluidos

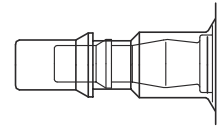

Perfil británico

Protecciones contra el polvo (P. 357)
para acoplar la pieza.-No. SK23S



Simple obturación

Presión de trabajo*:
hasta 35 bar

Material:

- Enchufe: Latón / acero niquelado
- Acoplador: Acero niquelado
- Junta: NBR

Temperatura de trabajo:
-20°C hasta +100°C (NBR)

Caudal de aire:

850 l/min.
presión de entrada 6 bar, caída de presión 0,5 bar

Caudal de agua:

12 l/min.
caída de presión de 0,5 bar

* máxima presión estática de trabajo con un factor de diseño de 4 a 1.



Simple obturación

19KAAK Enchufe con válvula, rosca macho

Latón/acero niquelado, NBR

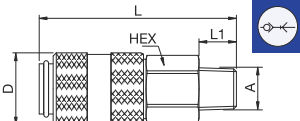
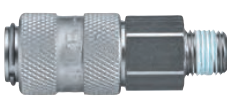

A			HEX	L	L1	D
R1/4	19KAAK13MPN	9105 19 13	19	63	12	23
R3/8	19KAAK17MPN	9105 19 17	19	62	12	23
R1/2	19KAAK21MPN		22	68	17	23



Simple obturación

19KATF Enchufe con válvula, conexión manguera

Latón/acero niquelado, NBR

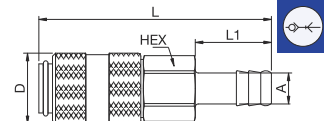
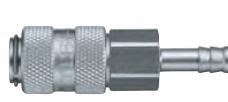

A			HEX	L	L1	D
6	19KATF06MPN	9123 19 06	19	76	25	23
8	19KATF08MPN		19	76	25	23
10	19KATF10MPN		19	76	25	23
13	19KATF13MPN		19	76	25	23

19KAIW Enchufe con válvula, rosca hembra

Latón/acero niquelado, NBR

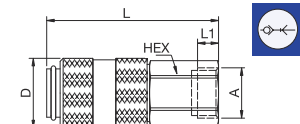

A			HEX	L	L1	D
G1/4	19KAIW13MPN	9114 19 13	19	58	9	23
G3/8	19KAIW17MPN		19	58	9	23
G1/2	19KAIW21MPN		24	60	12	23

Serie 19 - Latón / Acero

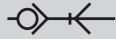

Simple obturación

19SFAK Acoplador sin válvula, rosca macho

Acero niquelado

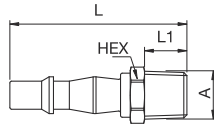

A			HEX	L	L1
R1/4	19SFAK13SXN	9084 19 13	14	50	12
R3/8	19SFAK17SXN		17	50	12

19SFIW Acoplador sin válvula, rosca hembra

Acero niquelado

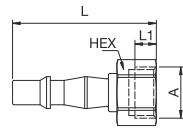

A			HEX	L	L1
G1/4	19SFIW13SXN		17	46	9
G3/8	19SFIW17SXN		19	47	9

19SFTF Acoplador sin válvula, conexión manguera

Acero niquelado

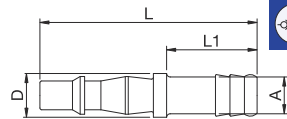

A			L	L1	D
6	19SFTF06SXN		60	25	12
8	19SFTF08SXN		60	25	12
10	19SFTF10SXN	9085 19 10	60	25	12

Serie 22 - Latón / Acero

Diámetro nominal
5,5 = 25 mm²



Sistema de enchufe automático con una sola mano. Válvula de alto caudal para un flujo óptimo y una baja caída de presión. Especialmente adecuada para su uso con medios gaseosos en la industria. El manguito de acero contrarresta las fuerzas oscilantes. La alta profundidad de inserción está garantizada por una guía de enchufe optimizada.

- Disponible a petición:
 - con conexiones finales adicionales
 - otras juntas para diferentes rangos de temperatura y fluidos

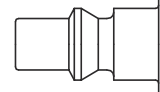

Perfil de ARO

Protecciones contra el polvo (P. 357)
para acoplar la pieza.-No. SK23S



Simple obturación

Presión de trabajo*:
hasta 35 bar

Material:

- Enchufe: Latón / acero niquelado
- Acoplador: Acero niquelado o de latón
- Junta: NBR

Temperatura de trabajo:
-20°C hasta +100°C (NBR)

Caudal de aire:

800 l/min.
presión de entrada 6 bar, caída de presión 0,5 bar

Caudal de agua:

15 l/min.
caída de presión de 0,5 bar

* máxima presión estática de trabajo con un factor de diseño de 4 a 1.



Simple obturación

22KAAK Enchufe con válvula, rosca macho

Latón/acero niquelado, NBR

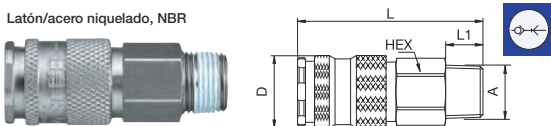

A			HEX	L	L1	D
R1/4	22KAAK13MPN	9105 22 13	19	61	12	23
R3/8	22KAAK17MPN	9105 22 17	19	60	12	23
R1/2	22KAAK21MPN	9105 22 21	22	61	17	23



Simple obturación

22KATF Enchufe con válvula, conexión manguera

Latón/acero niquelado, NBR

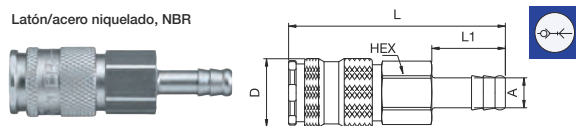

A			HEX	L	L1	D
6	22KATF06MPN		19	74	25	23
8	22KATF08MPN	9123 22 08	19	74	25	23
9	22KATF09MPN		19	74	25	23
10	22KATF10MPN	9123 22 10	19	74	25	23
13	22KATF13MPN		19	74	25	23

22KAIW Enchufe con válvula, rosca hembra

Latón/acero niquelado, NBR

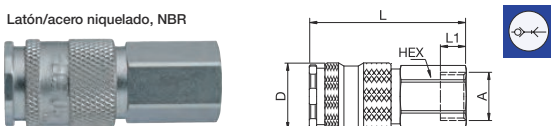

A			HEX	L	L1	D
G1/4	22KAIW13MPN	9114 22 13	19	56	9	23
G3/8	22KAIW17MPN	9114 22 17	19	55	9	23
G1/2	22KAIW21MPN	9114 22 21	24	58	9	23

Serie 22 - Latón / Acero



Simple obturación

22SFA Acoplador sin válvula, rosca macho

Acero o latón niquelado

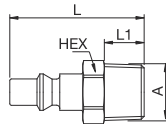

A			HEX	L	L1	Versión
R1/8	22SFAK10SXN		12	35	9	Acero niquelado
	22SFAK13SXN	9084 22 13	14	41	12	Acero niquelado
R1/4	22SFAK13MXX		14	41	12	Latón
G1/4	22SAW13MXX		14	41	12	Latón
R3/8	22SFAK17SXN	9084 22 17	17	41	12	Acero niquelado
G3/8	22SAW17MXX		17	41	12	Latón
R1/2	22SFAK21SXN	9084 22 21	22	46	17	Acero niquelado
G1/2	22SAW21MXX		22	46	17	Latón

22SFIW Acoplador sin válvula, rosca hembra

Acero o latón niquelado

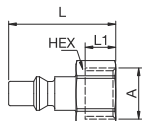

A			HEX	L	L1	Versión
G1/4	22SFIW13SXN	9086 22 13	17	35	9	Acero niquelado
	22SFIW13MXX		17	35	9	Latón
G3/8	22SFIW17SXN	9086 22 17	19	35	10	Acero niquelado
G1/2	22SFIW21SXN	9086 22 21	24	35	12	Acero niquelado

22SFTF Acoplador sin válvula, conexión manguera

Acero o latón niquelado

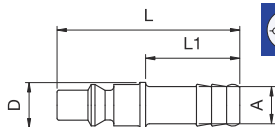

A			L	L1	D	Versión
6	22SFTF06SXN	9085 22 06	49	25	12	Acero niquelado
	22SFTF06MXX		49	25	12	Latón
8	22SFTF08SXN	9085 22 08	49	25	12	Acero niquelado
9	22SFTF09SXN	9085 22 09	49	25	12	Acero niquelado
	22SFTF10SXN	9085 22 10	49	25	12	Acero niquelado
10	22SFTF10MXX		49	25	12	Latón
	22SFTF13SXN	9085 22 13	49	25	15	Acero niquelado

Serie 24 - Latón / Acero

Diámetro nominal
5,5 = 25 mm²



Enchufe automático de latón industrial de 1/4" según ISO 6150 B y US MIL-SPEC 4109. Sistema de enchufe automático con operación a una sola mano, que se destaca por su diseño de latón macizo y su correspondiente diseño de manguito. El enchufe de acero endurecido contrarresta las vibraciones y los efectos de las fuerzas externas.

- Disponible a petición:
 - con conexiones finales adicionales
 - otras juntas para diferentes rangos de temperatura y fluidos

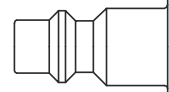

Perfil ISO 6150 B



Presión de trabajo*:
hasta 35 bar

Material:

- Enchufe: Latón
- Acoplador: Acero niquelado o de latón
- Junta: NBR

Temperatura de trabajo:
-20°C hasta +100°C (NBR)

Caudal de aire:

820 l/min.

presión de entrada 6 bar, caída de presión 0,5 bar

Caudal de agua:

7,4 l/min.

caída de presión de 0,5 bar

* máxima presión estática de trabajo con un factor de diseño de 4 a 1.







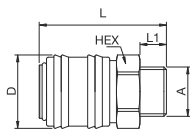

 Simple obturación

 Simple obturación

24KAAW Enchufe con válvula, rosca macho

Latón, NBR









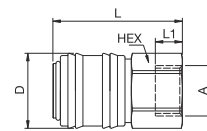

A			HEX	L	L1	D	Versión	
G1/4			24KAAW13MPX	22	43	9	25	Latón
			24KAAW13MPN	9101 24 13	22	43	9	25
G3/8			24KAAW17MPX	22	43	9	25	Latón
			24KAAW17MPN	9101 24 17	22	43	9	25
G1/2			24KAAW21MPX	22	46	12	25	Latón
			24KAAW21MPN	9101 24 21	22	46	12	25

24KAIW Enchufe con válvula, rosca hembra

Latón, NBR



A			HEX	L	L1	D	Versión	
G1/4			24KAIW13MPX	22	43	11	25	Latón
			24KAIW13MPN	9114 24 13	22	43	11	25
G3/8			24KAIW17MPX	22	43	9	25	Latón
			24KAIW17MPN	9114 24 17	22	43	9	25
G1/2			24KAIW21MPX	22	46	12	25	Latón
			24KAIW21MPN	9114 24 21	22	46	12	25

Serie 24 - Latón / Acero



Simple obturación

24KATF Enchufe con válvula, conexión manguera

Latón, NBR

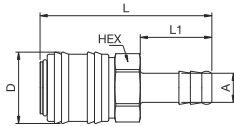

A			HEX	L	L1	D	Versión
6	24KATF06MPX		21	60	25	25	Latón
	24KATF06MPN	9123 24 06	21	60	25	25	Latón niquelado
8	24KATF08MPX		21	60	25	25	Latón
	24KATF08MPN	9123 24 08	21	60	25	25	Latón niquelado
9	24KATF09MPX		21	60	25	25	Latón
	24KATF09MPN		21	60	25	25	Latón niquelado
10	24KATF10MPX		21	60	25	25	Latón
	24KATF10MPN	9123 24 10	21	60	25	25	Latón niquelado
13	24KATF13MPX		21	60	25	25	Latón
	24KATF13MPN		21	60	25	25	Latón niquelado



Simple obturación

23SFTF Acoplador sin válvula, conexión manguera

Acero o latón niquelado

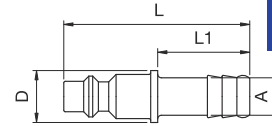

A			L	L1	D	Versión
6	23SFTF06SXN	9085 23 06	51	25	14	Acero niquelado
	23SFTF06MXX		51	25	14	Latón
8	23SFTF08SXN	9085 23 08	51	25	14	Acero niquelado
	23SFTF09SXN		51	25	14	Acero niquelado
9	23SFTF09MXX		51	25	14	Latón
10	23SFTF10SXN	9085 23 10	51	25	14	Acero niquelado
13	23SFTF13SXN		51	25	14	Acero niquelado

23SFA Acoplador sin válvula, rosca macho

Acero o latón niquelado

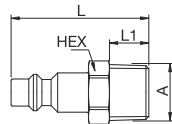

A			HEX	L	L1	Versión
R1/8	23SFAK10SXN		13	39	9	Acero niquelado
G1/8	23SFAW10SXN	9087 23 10	14	35	7	Acero niquelado
R1/4	23SFAK13SXN		14	42	12	Acero niquelado
	23SFAW13SXN	9087 23 13	14	42	12	Acero niquelado
G1/4	23SFAW13MXX		14	42	12	Latón
R3/8	23SFAK17SXN		17	42	12	Acero niquelado
	23SFAW17MXX		17	42	12	Latón
G3/8	23SFAW17SXN	9087 23 17	17	42	12	Acero niquelado
R1/2	23SFAK21SXN		22	48	17	Acero niquelado
G1/2	23SFAW21SXN	9087 23 21	22	42	12	Acero niquelado

23SFIW Acoplador sin válvula, rosca hembra

Acero niquelado

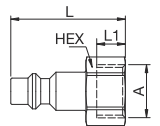

A			HEX	L	L1
G1/8	23SFIW10SXN	9086 23 10	14	36	9
G1/4	23SFIW13SXN	9086 23 13	17	36	9
G3/8	23SFIW17SXN	9086 23 17	19	36	9
G1/2	23SFIW21SXN	9086 23 21	24	39	12

Serie 23 - Latón / Acero

Diámetro nominal
5,5 = 25 mm²



Enchufe automático industrial de 1/4" con tecnología UltraFlo de acuerdo con ISO 6150 B y US Mil. Spec. 4109. Especialmente adecuado para el uso con medios gaseosos en la industria. El manguito de acero contrarresta las fuerzas oscilantes. Variantes especiales con válvula de latón para uso con líquidos. Alto rendimiento de caudal con baja caída de presión y múltiples posibilidades de conexión.

- Disponible a petición:
 - con conexiones finales adicionales
 - otras juntas para diferentes rangos de temperatura y fluidos

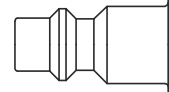

Perfil ISO 6150 B



Simple obturación

Presión de trabajo*:
hasta 35 bar

Material:

- Enchufe: Latón niquelado
- Acoplador: Acero niquelado o de latón
- Junta: NBR

Temperatura de trabajo:
-20°C hasta +100°C (NBR)

Caudal de aire:

960 l/min.
presión de entrada 6 bar, caída de presión 0,5 bar

Caudal de agua:

14 l/min.
caída de presión de 0,5 bar

* máxima presión estática de trabajo con un factor de diseño de 4 a 1.



Simple obturación

23KAA Enchufe con válvula, rosca macho

Latón niquelado, NBR

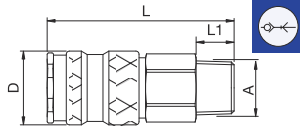

A		HEX	L	L1	D	
R1/4	23KAAK13MPN		19	61	12	23
G1/4	23KAAW13MPN	9101 23 13	19	57	9	23
R3/8	23KAAK17MPN		19	60	12	23
G3/8	23KAAW17MPN	9101 23 17	19	57	9	23
R1/2	23KAAK21MPN		22	61	17	23



Simple obturación

23KAIW Enchufe con válvula, rosca hembra

Latón niquelado, NBR

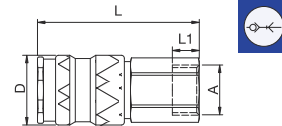

A		HEX	L	L1	D	
G1/4	23KAIW13MPN	9114 23 13	19	56	9	23
G3/8	23KAIW17MPN	9114 23 17	19	54	9	23
G1/2	23KAIW21MPN	9114 23 21	24	58	9	23

Serie 23 - Latón / Acero

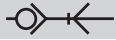

Simple obturación

23KATF Enchufe con válvula, conexión manguera

Latón niquelado, NBR Latón niquelado, NBR

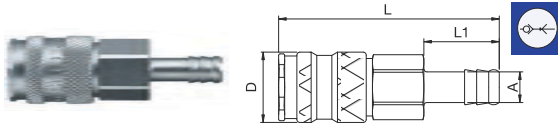

A			HEX	L	L1	D
6						
6	23KATF06MPN	9123 23 06	19	74	25	23
8	23KATF08MPN	9123 23 08	19	74	25	23
9	23KATF09MPN		19	74	25	23
10	23KATF10MPN	9123 23 10	19	74	25	23
13	23KATF13MPN		19	74	25	23



Simple obturación

23SFTF Acoplador sin válvula, conexión manguera

Acero o latón niquelado

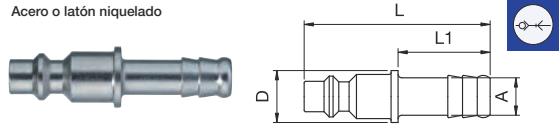

A			L	L1	D	Versión
6						
6	23SFTF06SXN	9085 23 06	51	25	14	Acero niquelado
	23SFTF06MXX		51	25	14	Latón
8	23SFTF08SXN	9085 23 08	51	25	14	Acero niquelado
	23SFTF09SXN		51	25	14	Acero niquelado
9	23SFTF09MXX		51	25	14	Latón
10	23SFTF10SXN	9085 23 10	51	25	14	Acero niquelado
13	23SFTF13SXN		51	25	14	Acero niquelado

23SFA Acoplador sin válvula, macho

Acero o latón niquelado

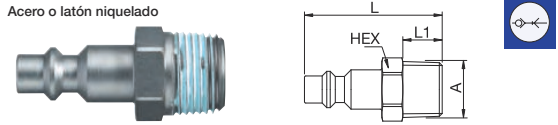

A			HEX	L	L1	Versión
R1/8						
R1/8	23SFAK10SXN		13	39	9	Acero niquelado
G1/8	23SFAW10SXN	9087 23 10	14	35	7	Acero niquelado
R1/4	23SFAK13SXN		14	42	12	Acero niquelado
G1/4	23SFAW13SXN	9087 23 13	14	42	12	Acero niquelado
	23SFAW13MXX		14	42	12	Latón
R3/8	23SFAK17SXN		17	42	12	Acero niquelado
	23SFAW17MXX		17	42	12	Latón
G3/8	23SFAW17SXN	9087 23 17	17	42	12	Acero niquelado
R1/2	23SFAK21SXN		22	48	17	Acero niquelado
G1/2	23SFAW21SXN	9087 23 21	22	42	12	Acero niquelado

23SFIW Acoplador sin válvula, rosca hembra

Acero niquelado

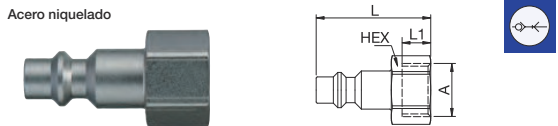

A			HEX	L	L1
G1/8					
G1/8	23SFIW10SXN	9086 23 10	14	36	9
G1/4	23SFIW13SXN	9086 23 13	17	36	9
G3/8	23SFIW17SXN	9086 23 17	19	36	9
G1/2	23SFIW21SXN	9086 23 21	24	39	12

Serie 1400 - Latón / Acero

Diámetro nominal
5,5 = 25 mm²



energy
saver

Enchufe automático industrial Rectus premium 1/4" según ISO 6150 B. Adecuado para aplicaciones de aire comprimido con un consumo de aire superior a la media. Sistema de enchufe automático con operación de una sola mano. Válvula de caudal ultra alto para un flujo óptimo y una baja caída de presión.

- Disponible a petición:

- con conexiones finales adicionales
- otras juntas para diferentes rangos de temperatura y fluidos

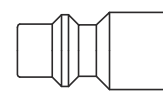

Perfil ISO 6150 B

Protecciones contra el polvo (P. 357)
para acoplar la pieza.-No. SK23S



Simple obturación

Presión de trabajo*:
hasta 35 bar

Material:

- Enchufe: Latón niquelado, Acero tratado con QPQ
- Acoplador: Acero niquelado o de latón
- Junta: NBR

Temperatura de trabajo:
-20°C hasta +100°C (NBR)

Caudal de aire:

950 l/min.
presión de entrada 6 bar, caída de presión 0,5 bar

Caudal de agua:

13 l/min.
caída de presión de 0,5 bar

* máxima presión estática de trabajo con un factor de diseño de 4 a 1.



Simple obturación

1400KAAK Enchufe con válvula, rosca macho

Latón niquelado, acero tratado con QPQ, NBR



A	HEX	L	L1	D	
R1/4	1400KAAK13SPN	19	65	12	23
R3/8	1400KAAK17SPN	19	65	12	23
R1/2	1400KAAK21SPN	22	59,5	17	23



Simple obturación

1400KATF Enchufe con válvula, conexión manguera

Latón niquelado, acero tratado con QPQ, NBR

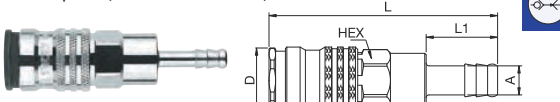

A	HEX	L	L1	D	
6	1400KATF06SPN	19	80	25	23
8	1400KATF08SPN	19	80	25	23
9	1400KATF09SPN	19	80	25	23
10	1400KATF10SPN	19	80	25	23
13	1400KATF13SPN	19	80	25	23

1400KAIW Enchufe con válvula, rosca hembra

Latón niquelado, acero tratado con QPQ, NBR

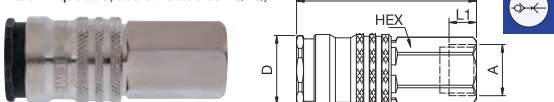

A	HEX	L	L1	D	
G1/4	1400KAIW13SPN	19	59	9	23
G3/8	1400KAIW17SPN	19	59	9	23
G1/2	1400KAIW21SPN	24	62	12	23

Serie 1400 - Latón / Acero



Simple obturación

23SFA Acoplador sin válvula, rosca macho

Acero o latón niquelado

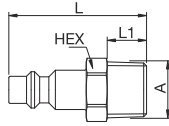
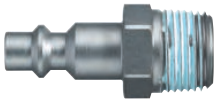

A			HEX	L	L1	Versión
R1/8			13	39	9	Acero niquelado
G1/8		9087 23 10	14	35	7	Acero niquelado
R1/4		9087 23 13	14	42	12	Acero niquelado
G1/4		9087 23 13	14	42	12	Acero niquelado
		23SFAW13MXX	14	42	12	Latón
R3/8		9087 23 17	17	42	12	Acero niquelado
G3/8		9087 23 17	17	42	12	Acero niquelado
		23SFAW17MXX	17	42	12	Latón
R1/2		9087 23 21	22	48	17	Acero niquelado
G1/2		9087 23 21	22	42	12	Acero niquelado

23SFIW Acoplador sin válvula, rosca hembra

Acero niquelado

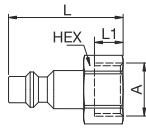

A			HEX	L	L1
G1/8			14	36	9
G1/4		9086 23 13	17	36	9
G3/8		9086 23 17	19	36	9
G1/2		9086 23 21	24	39	12

23SFTF Acoplador sin válvula, conexión manguera

Acero o latón niquelado

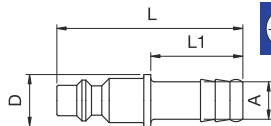

A			L	L1	D	Versión
6			51	25	14	Acero niquelado
		9085 23 06				Latón
8		9085 23 08	51	25	14	Acero niquelado
		23SFTF09SXX				Acero niquelado
9		9085 23 10	51	25	14	Acero niquelado
		23SFTF09MXX				Latón
10		9085 23 10	51	25	14	Acero niquelado
13		23SFTF13SXX	51	25	14	Acero niquelado

Serie 52 - Latón / Acero

Diámetro nominal
6 = 30 mm²



Sistema de enchufe automático con el perfil industrial alemán.
Sistema de enchufe automático con una sola mano. Válvula de alto caudal para un flujo óptimo y una baja caída de presión.
Enchufe automático robusto de diseño delgado, principalmente para aplicaciones neumáticas. El manguito de acero contrarresta las fuerzas oscilantes. La alta profundidad de inserción está garantizada por una guía de enchufe optimizada.

- Disponible a petición:
 - con conexiones finales adicionales
 - otras juntas para diferentes rangos de temperatura y fluidos

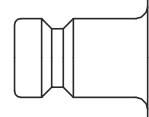

Perfil alemán

Protecciones contra el polvo (P. 357)
para acoplar la pieza.-No. SK23S
para enchufe la pieza.-No. SK12S

KA Simple obturación

Presión de trabajo*:
hasta 50 bar

Material:

- Enchufe: Latón / acero niquelado
- Acoplador: Acero niquelado
- Junta: NBR

Temperatura de trabajo:
-20°C hasta +100°C (NBR)

Caudal de aire:

1.100 l/min.
presión de entrada 6 bar, caída de presión 0,5 bar

Caudal de agua:

14 l/min.
caída de presión de 0,5 bar

KB Doble obturación

Presión de trabajo*:
hasta 50 bar

Material:

- Enchufe: Latón / acero niquelado
- Acoplador: Latón / acero niquelado
- Junta: NBR

Temperatura de trabajo:
-20°C hasta +100°C (NBR)

Caudal de aire:

730 l/min.
presión de entrada 6 bar, caída de presión 0,5 bar

Caudal de agua:

10 l/min.
caída de presión de 0,5 bar

* máxima presión estática de trabajo con un factor de diseño de 4 a 1.



Simple obturación/Doble obturación



Simple obturación/Doble obturación

52KBAW Enchufe con válvula, rosca macho

Latón/acero niquelado, NBR

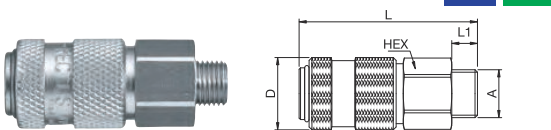

A	HEX	L	L1	D	
G1/4	52KBAW13SPN	22	62	9	25
G3/8	52KBAW17SPN	22	62	9	25
G1/2	52KBAW21SPN	22	65	12	25

52KBIW Enchufe con válvula, rosca hembra

Latón/acero niquelado, NBR

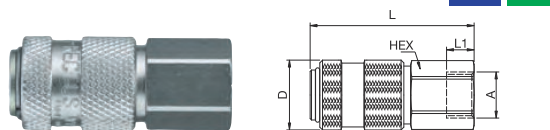

A	HEX	L	L1	D	
G1/4	52KBIW13SPN	22	62	10	25
G3/8	52KBIW17SPN	22	60	10	25
G1/2	52KBIW21SPN	22	65	13	25

Serie 52 - Latón / Acero

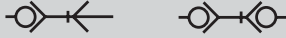

Simple obturación/Doble obturación

52KBTf Enchufe con válvula, conexión manguera

Latón/acero niquelado, NBR

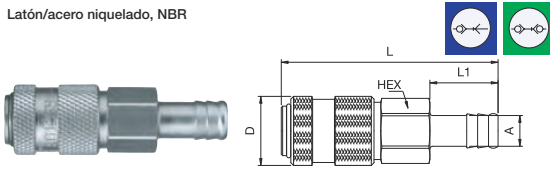

A		HEX	L	L1	D
6	52KBTf06SPN	21	80	25	25
9	52KBTf09SPN	21	80	25	25
13	52KBTf13SPN	21	80	25	25

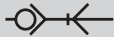

Simple obturación

52SFAW Acoplador sin válvula, rosca macho

Acero niquelado

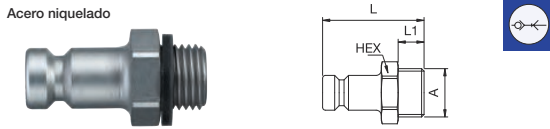

A		HEX	L	L1
G1/4	52SFAW13SXN	17	35	9
G3/8	52SFAW17SXN	19	35	9
G1/2	52SFAW21SXN	24	38	12

52SFIW Acoplador sin válvula, rosca hembra

Acero niquelado

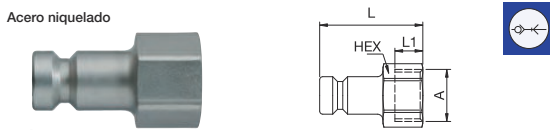

A		HEX	L	L1
G1/4	52SFIW13SXN	17	33	9
G3/8	52SFIW17SXN	19	33	9
G1/2	52SFIW21SXN	24	36	12

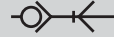

Simple obturación

52SFTF Acoplador sin válvula, conexión manguera

Acero niquelado

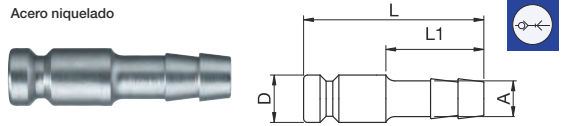

A		L	L1	D
6	52SFTF06SXN	46	25	12
9	52SFTF09SXN	46	25	12
13	52SFTF13SXN	53	30	12



Doble obturación

52SBAW Acoplador con válvula, rosca macho

Latón/acero niquelado, NBR

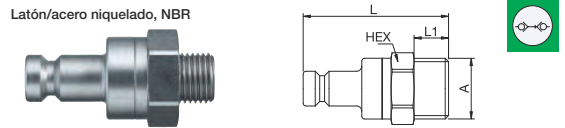

A		HEX	L	L1
G1/4	52SBAW13SPN	22	48	9
G3/8	52SBAW17SPN	22	48	9
G1/2	52SBAW21SPN	22	48	12

52SBIW Acoplador con válvula, rosca hembra

Latón/acero niquelado, NBR

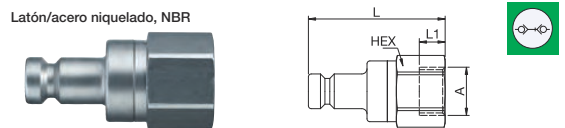

A		HEX	L	L1
G1/4	52SBIW13SPN	22	48	9
G3/8	52SBIW17SPN	22	48	9
G1/2	52SBIW21SPN	22	51	10

52SBTF Acoplador con válvula, conexión manguera

Latón/acero niquelado, NBR

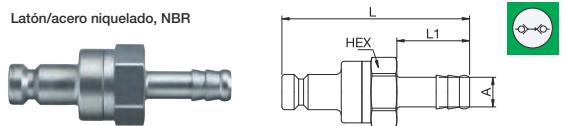

A		HEX	L	L1
6	52SBTF06SPN	21	77,5	25
9	52SBTF09SPN	21	77,5	25
13	52SBTF13SPN	21	77,5	25

Serie 26 - Latón / Acero

Diámetro nominal
7,2 = 40 mm²



Enchufe automático universal de latón con perfil industrial estándar europeo. Sistema de enchufe automático con accionamiento con una sola mano y válvula estándar. Pequeño tamaño de masa. El diseño ergonómico del manguito evita la entrada de suciedad en el cuerpo de la válvula.

- Disponible a petición:
 - en material de latón con recubrimiento de níquel
 - con conexiones finales adicionales
 - otras juntas para diferentes rangos de temperatura y fluidos

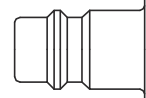

Perfil de Euro



Simple obturación

Presión de trabajo*:
hasta 35 bar

Material:

- Enchufe: Latón
- Acoplador: Latón
- Junta: NBR

Temperatura de trabajo:
-20°C hasta +100°C (NBR)

Caudal de aire:

1.070 l/min.
presión de entrada 6 bar, caída de presión 0,5 bar

Caudal de agua:

18 l/min.
caída de presión de 0,5 bar



Doble obturación

Presión de trabajo*:
hasta 35 bar

Material:

- Enchufe: Latón
- Acoplador: Latón
- Junta: NBR

Temperatura de trabajo:
-20°C hasta +100°C (NBR)

Caudal de aire:

950 l/min.
presión de entrada 6 bar, caída de presión 0,5 bar

Caudal de agua:

8,8 l/min.
caída de presión de 0,5 bar

* máxima presión estática de trabajo con un factor de diseño de 4 a 1.



Simple obturación



Simple obturación

26KAA Enchufe con válvula, rosca macho

Latón, NBR

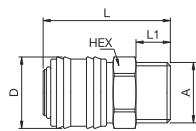

A	Icon	Icon	HEX	L	L1	D	Versión
G1/8			22	43	9	25	Latón
			9101	26	10	22	Latón niquelado
G1/4			22	39	9	25	Latón
			9101	26	13	22	Latón niquelado
G3/8			22	41	9	25	Latón
			9101	26	17	22	Latón niquelado
G1/2			22	44	12	25	Latón
			9101	26	21	22	Latón niquelado
			24	44	12	25	Latón
M14 x 1,5			22	43	10	25	Latón
M16 x 1,5			22	43	11	25	Latón
M18 x 1,5			22	43	11	25	Latón

26KAI Enchufe con válvula, rosca hembra

Latón, NBR

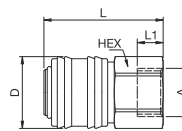

A	Icon	Icon	HEX	L	L1	D	Versión
G1/8			22	41	8	25	Latón
G1/4			22	41	9	25	Latón
			9114	26	13	22	Latón niquelado
G3/8			22	41	9	25	Latón
			9114	26	17	22	Latón niquelado
G1/2			24	44	10	25	Latón
			9114	26	21	24	Latón niquelado
M14 x 1,5			22	41	9	25	Latón
M16 x 1,5			22	41	9	25	Latón
M18 x 1,5			22	44	9	25	Latón

Serie 26 - Latón / Acero



Simple obturación

26KAT Enchufe con válvula, conexión manguera

Latón, NBR

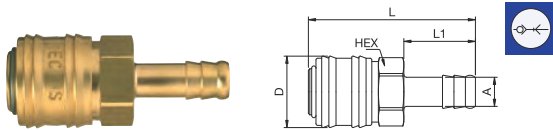

A		HEX	L	L1	D
6	26KATF06MPX	21	58	25	25
8	26KATF08MPX	21	58	25	25
9	26KATF09MPX	21	58	25	25
10	26KATF10MPX	21	58	25	25
13	26KATF13MPX	21	58	25	25
6	26KATP06MPX	21	58	20,5	25
10	26KATP10MPX	21	58	24	25
13	26KATP13MPX	21	58	28	25

26KAKO Enchufe con válvula, con conexión de manguera de plástico

Latón, NBR

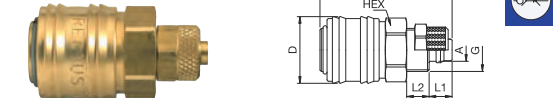

A		HEX	G	L	L1	L2	D
4 x 6	26KAKO06MPX	21	M10x1	58	7	6	25
6 x 8	26KAKO08MPX	21	M12x1	45	7	6	25
8 x 10	26KAKO10MPX	21	M16x1	49	9	8	25
9 x 12	26KAKO12MPX	21	M16x1	49	9	8	25

26KATS Enchufe con válvula, montaje en panel con manguera

Latón, NBR

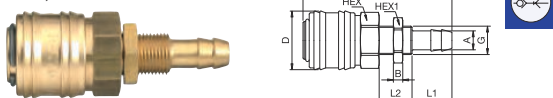

A		HEX	HEX1	B	G	L	L1	L2	D
6	26KATS06MPX	21	17	4	M12x1	60	17	10	25
10	26KATS10MPX	21	17	4	G1/4	72	25	14	25

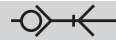

Simple obturación

26KAKK Enchufe con válvula, conexión de manguera plástica con protector de resorte

Latón, NBR

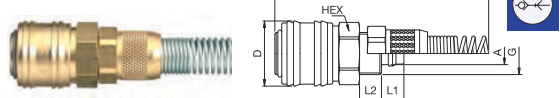

A		HEX	G	L	L1	L2	D
4 x 6	26KAKK06MPX	21	M10x1	120	7	6	25
6 x 8	26KAKK08MPX	21	M12x1	132	7	6	25
8 x 10	26KAKK10MPX	21	M16x1	143	9	8	25
9 x 12	26KAKK12MPX	21	M16x1	150	9	8	25

26SFA Acoplador sin válvula, rosca macho

Latón

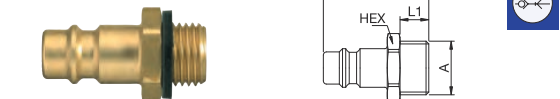

A		HEX	L	L1
G1/8	26SAFW10MXX	14	31	7
G1/4	26SAFW13MXX	17	33	9
G3/8	26SAFW17MXX	19	33	9
G1/2	26SAFW21MXX	24	38	12
M14 x 1,5	26SFAD14MXX	17	35	10
M16 x 1,5	26SFAD16MXX	19	36	11
M18 x 1,5	26SFAD18MXX	22	37	11

26SFI Acoplador sin válvula, rosca hembra

Latón

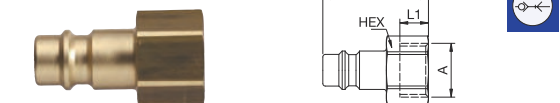

A		HEX	L	L1
G1/8	26SFIW10MXX	14	30	7
G1/4	26SFIW13MXX	17	33	10
G3/8	26SFIW17MXX	19	33	10
G1/2	26SFIW21MXX	24	35	12
M14 x 1,5	26SFIM14MXX	17	33	10
M16 x 1,5	26SFIM16MXX	19	33	10

Serie 26 - Latón / Acero



Simple obturación

26SFT Acoplador sin válvula, conexión manguera

Latón

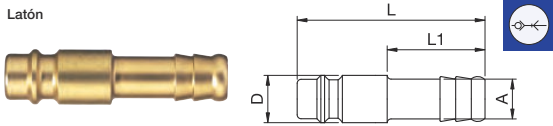

A		L	L1	D
4	26SFTF04MXX	48	25	12
6	26SFTF06MXX	48	25	12
8	26SFTF08MXX	48	25	12
9	26SFTF09MXX	48	25	12
10	26SFTF10MXX	48	25	12
13	26SFTF13MXX	48	25	15
6	26SFTP06MXX	43	20.5	16
10	26SFTP10MXX	46	24	22
13	26SFTP13MXX	50	28	24

26SFKO Acoplador sin válvula, conexión manguera de plástico

Latón

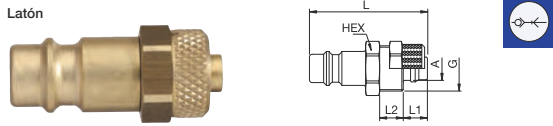

A		HEX	G	L	L1	L2	D
4 x 6	26SFKO06MXX		M10x1	34	7	6	12
6 x 8	26SFKO08MXX		M12x1	34	7	6	12
8 x 10	26SFKO10MXX	17	M16x1	42	9	6	
9 x 12	26SFKO12MXX	17	M16x1	42	9	8	

26SFTS Acoplador sin válvula, montaje en panel con manguera

Latón

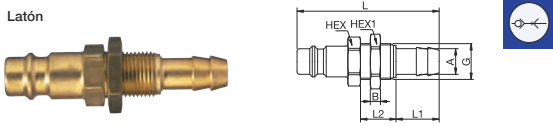

A		HEX	HEX1	B	G	L	L1	L2
10	26SFTS10MXX	17	19	4	M14x1	56	17	14

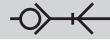

Simple obturación

26SFKK Acoplador sin válvula, conexión de manguera de plástico con protector de resorte

Latón

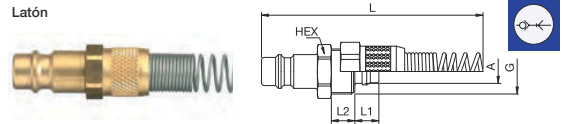

A		HEX	G	L	L1	L2	D
4 x 6	26SFKK06MXX		M10x1	120	7	6	12
6 x 8	26SFKK08MXX		M12x1	127	7	6	12
8 x 10	26SFKK10MXX	17	M16x1	135	9	8	
9 x 12	26SFKK12MXX	17	M16x1	142	9	8	

26SRTF Acoplador sin válvula, Eliminator de retroceso conexión manguera

Latón

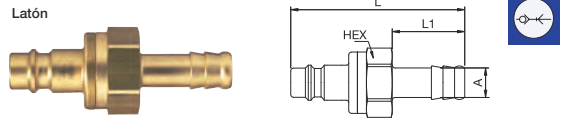

A		HEX	L	L1
6	26SRTF06MXX	21	60	25
8	26SRTF08MXX	21	60	25
9	26SRTF09MXX	21	60	25
10	26SRTF10MXX	21	60	25
13	26SRTF13MXX	21	60	25

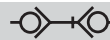

Doble obturación

26KBA Enchufe con válvula, rosca macho

Latón, NBR

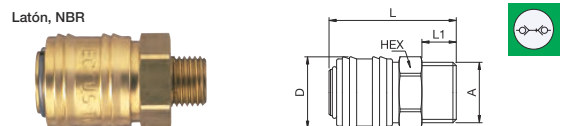

A		HEX	L	L1	D
G1/8	26KBAW10MPX	22	43	9	25
G1/4	26KBAW13MPX	22	39	9	25
G3/8	26KBAW17MPX	22	41	9	25
G1/2	26KBAW21MPX	24	44	10	25
M14 x 1,5	26KBAD14MPX	22	43	10	25
M16 x 1,5	26KBAD16MPX	22	43	11	25
M18 x 1,5	26KBAD18MPX	22	43	11	25

Serie 26 - Latón / Acero

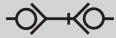

Doble obturación

26KBI Enchufe con válvula, rosca hembra

Latón, NBR

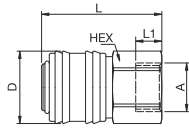

A		HEX	L	L1	D
G1/8	26KBIW10MPX	22	41	8	25
G1/4	26KBIW13MPX	22	41	9	25
G3/8	26KBIW17MPX	22	41	9	25
G1/2	26KBIW21MPX	24	44	10	25
M14 x 1,5	26KBIW14MPX	22	41	9	25
M16 x 1,5	26KBIW16MPX	22	41	9	25
M18 x 1,5	26KBIW18MPX	22	41	9	25

26KBT Enchufe con válvula, conexión manguera

Latón, NBR

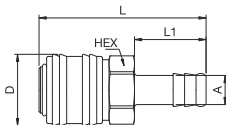
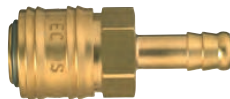

A		HEX	L	L1	D
6	26KBT06MPX	21	58	25	25
8	26KBT08MPX	21	58	25	25
9	26KBT09MPX	21	58	25	25
10	26KBT10MPX	21	58	25	25
13	26KBT13MPX	21	58	25	25
6	26KBT06MPX	21	58	20,5	25
10	26KBT10MPX	21	58	24	25
13	26KBT13MPX	21	58	20,5	25

26BK0 Enchufe con válvula, con conexión de manguera de plástico

Latón, NBR

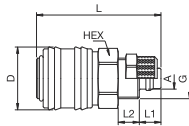

A		HEX	G	L	L1	L2	D
4 x 6	26BK006MPX	21	M10x1	45	7	6	25
6 x 8	26BK008MPX	21	M12x1	45	7	6	25
8 x 10	26BK010MPX	21	M16x1	49	9	8	25
9 x 12	26BK012MPX	21	M16x1	49	9	8	25

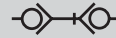

Doble obturación

26KBTs Enchufe con válvula, montaje en panel con manguera

Latón, NBR

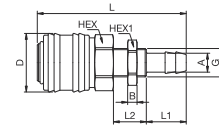

A		HEX	HEX1	B	G	L	L1	L2	D
6	26KBTs06MPX	21	17	4	M12x1	60	17	10	25
10	26KBTs10MPX	21	17	4	G1/4	72	25	14	25

26KBBK Enchufe con válvula, conexión de manguera plástica con protector de resorte

Latón, NBR

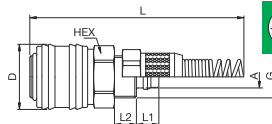

A		HEX	G	L	L1	L2	D
6 x 8	26KBBK08MPX	21	M12x1	132	7	6	25
8 x 10	26KBBK10MPX	21	M16x1	143	9	8	25
9 x 12	26KBBK12MPX	21	M16x1	150	9	8	25

Los acopladores de la Serie 26KB están disponibles en las siguientes versiones con la Serie 25 en la página 247.

Serie 13 - Latón / Acero

Diámetro nominal
7,5 = 45 mm²



Enchufe automático de latón robusto con perfil industrial japonés. Sistema de enchufe automático con una sola mano. Volúmenes de caudal superiores a la media y estructura resistente a los efectos de las fuerzas externas.

- Disponible a petición:
 - en material de latón con recubrimiento de níquel
 - con conexiones finales adicionales
 - otras juntas para diferentes rangos de temperatura y fluidos

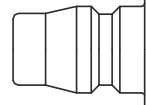

Perfil japonés



Simple obturación

Presión de trabajo*:
hasta 35 bar

Material:

- Enchufe: Latón
- Acoplador: Acero niquelado
- Junta: NBR

Temperatura de trabajo:
-20°C hasta +100°C (NBR)

Caudal de aire:

1.150 l/min.
presión de entrada 6 bar, caída de presión 0,5 bar

Caudal de agua:

16 l/min.
caída de presión de 0,5 bar

* máxima presión estática de trabajo con un factor de diseño de 4 a 1.



Simple obturación

13KAAK Enchufe con válvula, rosca macho

Latón, NBR

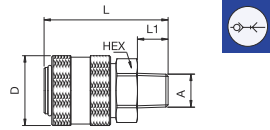

A	HEX	L	L1	D
R1/4	13KAAK13MPX	22	49	12 27
R3/8	13KAAK17MPX	22	49	12 27
R1/2	13KAAK21MPX	22	53	17 27



Simple obturación

13KATF Enchufe con válvula, conexión manguera

Latón, NBR

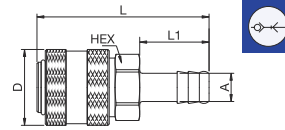
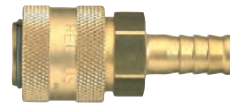

A	HEX	L	L1	D
6	13KATF06MPX	21	62	25 27
8	13KATF08MPX	21	62	25 27
10	13KATF10MPX	21	62	25 27
13	13KATF13MPX	21	62	25 27

13KAIW Enchufe con válvula, rosca hembra

Latón, NBR

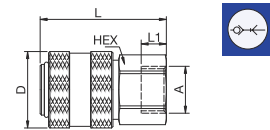

A	HEX	L	L1	D
G1/4	13KAIW13MPX	22	45	9 27
G3/8	13KAIW17MPX	22	45	9 27
G1/2	13KAIW21MPX	24	48	12 27

Serie 13 - Latón / Acero

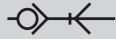

Simple obturación

13SFAK Acoplador sin válvula, rosca macho

Acero niquelado

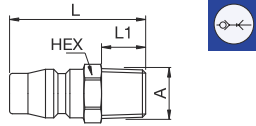

A		HEX	L	L1
R1/4	13SFAK13SXN	14	37	12
R3/8	13SFAK17SXN	17	37	12
R1/2	13SFAK21SXN	22	44	17

13SFIW Acoplador sin válvula, rosca hembra

Acero niquelado

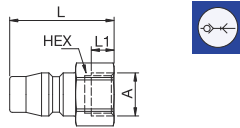

A		HEX	L	L1	
G1/4	13SFIW13SXN	9086 13 13	17	34	9
G3/8	13SFIW17SXN		19	34	9
G1/2	13SFIW21SXN		24	35	10

13SFTF Acoplador sin válvula, conexión manguera

Acero niquelado

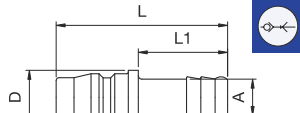

A		L	L1	D	
6	13SFTF06SXN	48	25	15	
8	13SFTF08SXN	48	25	15	
10	13SFTF10SXN	48	25	15	
13	13SFTF13SXN	9085 13 13	48	25	15

Serie 25 - Latón / Acero

Diámetro nominal
7,8 = 48 mm²



Enchufe automático industrial universal con perfil europeo estándar. Sistema de enchufe automático con una sola mano. Válvula de alto caudal para un flujo óptimo y una baja caída de presión. La serie se distingue por su diseño robusto y su larga vida útil, incluso con el uso más duro.

- Disponible a petición:
 - con conexiones finales adicionales
 - otras juntas para diferentes rangos de temperatura y fluidos

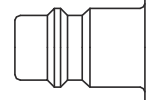

Perfil de Euro

Protecciones contra el polvo (P. 357)
para acoplar la pieza-No. SK23S
para enchufe la pieza-No. SK12S

KA Simple obturación

Presión de trabajo*:
hasta 35 bar

Material:

- Enchufe: Latón / acero niquelado
- Acoplador: Acero zincado
- Junta: NBR

Temperatura de trabajo:
-20°C hasta +100°C (NBR)

Caudal de aire:
1.800 l/min.
presión de entrada 6 bar, caída de presión 0,5 bar

Caudal de agua:
28 l/min.
caída de presión de 0,5 bar

KB Doble obturación

Presión de trabajo*:
hasta 35 bar

Material:

- Enchufe: Latón / acero niquelado
- Acoplador: Latón niquelado
- Junta: NBR

Temperatura de trabajo:
-20°C hasta +100°C (NBR)

Caudal de aire:
710 l/min.
presión de entrada 6 bar, caída de presión 0,5 bar

Caudal de agua:
7,1 l/min.
caída de presión de 0,5 bar

* máxima presión estática de trabajo con un factor de diseño de 4 a 1.

 Simple obturación

 Simple obturación

25KAA Enchufe con válvula, rosca macho

Latón/acero niquelado, NBR

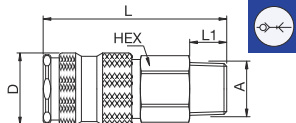

A		HEX	L	L1	D
R1/4	25KAAK13MPN	19	61	12	23
R3/8	25KAAK17MPN	19	60	12	23
R1/2	25KAAK21MPN	22	61	17	23
M14 x 1,5	25KAAD14MPN	19	59	10	23
M16 x 1,5	25KAAD16MPN	19	60	11	23
M18 x 1,5	25KAAD18MPN	19	60	11	23

25KAIW Enchufe con válvula, rosca hembra

Latón/acero niquelado, NBR

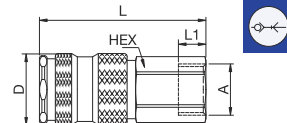

A		HEX	L	L1	D
G1/4	25KAIW13MPN	19	56	10	23
G3/8	25KAIW17MPN	19	55	9	23
G1/2	25KAIW21MPN	24	58	12	23

Serie 25 - Latón / Acero

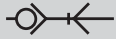

Simple obturación

25KAT Enchufe con válvula, conexión manguera

Latón/acero niquelado, NBR

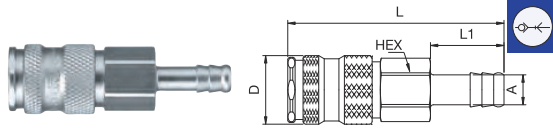

A		HEX	L	L1	D
6	25KATF06MPN	19	74	25	23
8	25KATF08MPN	19	74	25	23
9	25KATF09MPN	19	74	25	23
10	25KATF10MPN	19	74	25	23
13	25KATF13MPN	19	74	25	23
10	25KATP10MPN	19	73	24	23
13	25KATP13MPN	19	76	28	23

25KAKO Enchufe con válvula, con conexión de manguera de plástico

Latón/acero niquelado, NBR

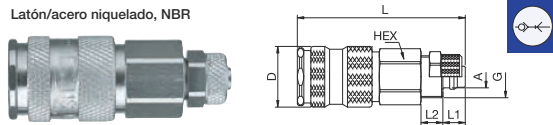

A		HEX	G	L	L1	L2	D
6 x 8	25KAKO08MPN	19	M12x1	61	7	6	23
8 x 10	25KAKO10MPN	19	M16x1	65	9	8	23
9 x 12	25KAKO12MPN	19	M16x1	65	9	8	23

25KATS Enchufe con válvula, montaje en panel con manguera

Latón/acero niquelado, NBR

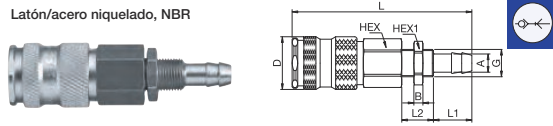

A		HEX	HEX1	B	G	L	L1	L2	D
8	25KATS08MPN	19	17	4	M12x1	80	17	14	23
10	25KATS10MPN	19	17	4	G1/4	87	25	14	23

25KAKK Enchufe con válvula, conexión de manguera plástica con protector de resorte

Latón/acero niquelado, NBR

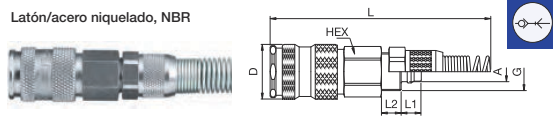

A		HEX	G	L	L1	L2	D
6 x 8	25KAKK08MPN	19	M12x1	144	7	6	23
8 x 10	25KAKK10MPN	19	M16x1	155	9	8	23
9 x 12	25KAKK12MPN	19	M16x1	162	9	8	23



Simple obturación

25SFA Acoplador sin válvula, rosca macho

Acero zincado

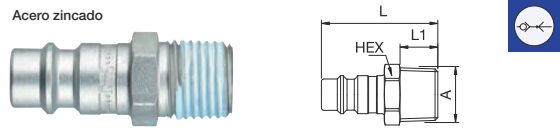

A		HEX	L	L1
R1/8	25SFAK10SXZ	13	33	9
G1/8	25SFAW10SXZ	9087 25 10	13	31 6.5
R1/4	25SFAK13SXZ	14	37	12
G1/4	25SFAW13SXZ	9087 25 13	17	33 8
R3/8	25SFAK17SXZ	17	37	12
G3/8	25SFAW17SXZ	9087 25 17	19	34 9
R1/2	25SFAK21SXZ	22	43	17
G1/2	25SFAW21SXZ	9087 25 21	24	38 10.5

25SFIW Acoplador sin válvula, rosca hembra

Acero zincado

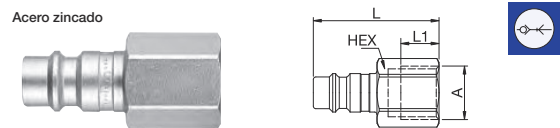

A		HEX	L	L1
G1/8	25SFIW10SXZ	9086 25 10	14	30 5
G1/4	25SFIW13SXZ	9086 25 13	17	38.5 12
G3/8	25SFIW17SXZ	9086 25 17	19	39.5 12
G1/2	25SFIW21SXZ	9086 25 21	24	44 14

25FAAK Acoplador sin válvula, junta flexible rosca macho

Acero niquelado, NBR

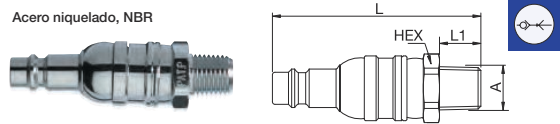

A		HEX	L	L1
R1/4	25FAAK13SPN	17	64	11

Serie 25 - Latón / Acero

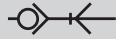

Simple obturación

25SFTF Acoplador sin válvula, conexión manguera

Acero zincado

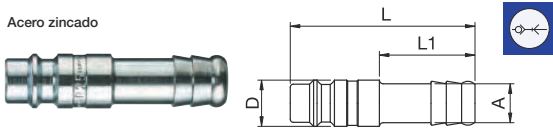

A			L	L1	D
6	25SFTF06SXZ	9085 25 06	48	25	12
8	25SFTF08SXZ	9085 25 08	48	25	12
9	25SFTF09SXZ	9085 25 09	48	25	12
10	25SFTF10SXZ	9085 25 10	48	25	12
13	25SFTF13SXZ	9085 25 13	48	25	15



Doble obturación

25KBA Enchufe con válvula, rosca macho

Latón/acero niquelado o latón niquelado, NBR

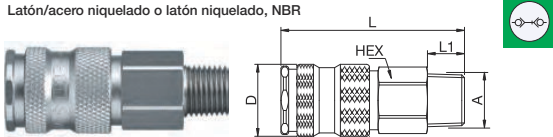

A		HEX	L	L1	D	Versión
R1/4	25KBAK13BPN	19	61	12	23	Latón niquelado
G1/4	25KBAW13MPN 9201 25 13	19	60	9	23	Latón/acero niquelado
R3/8	25KBAK17BPN	19	60	12	23	Latón niquelado
G3/8	25KBAW17MPN 9201 25 17	19	58	9	23	Latón/acero niquelado
R1/2	25KBAK21BPN	22	61	17	23	Latón niquelado
G1/5	25KBAW21MPN 9201 25 21	24	61	12	23	Latón/acero niquelado
M14x1.5	25KBAD14BPN	19	59	10	23	Latón niquelado
M16x1.5	25KBAD16BPN	19	60	11	23	Latón niquelado
M18x1.5	25KBAD18BPN	19	60	11	23	Latón niquelado

25KBIW Enchufe con válvula, rosca hembra

Latón/acero niquelado o latón niquelado, NBR

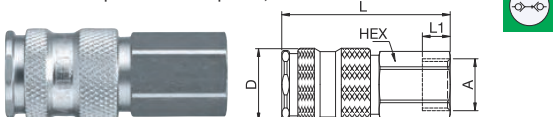

A		HEX	L	L1	D	Versión
G1/4	25KBIW13BPN	19	56	10	23	Latón niquelado
	25KBIW13MPN 9214 25 13	19	56	10	23	Latón/acero niquelado
G3/8	25KBIW17BPN	19	55	9	23	Latón niquelado
	25KBIW17MPN 9214 25 17	19	55	9	23	Latón/acero niquelado
G1/2	25KBIW21BPN	24	58	12	23	Latón niquelado
	25KBIW21MPN 9214 25 21	24	58	12	23	Latón/acero niquelado

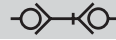

Doble obturación

25KBT Enchufe con válvula, conexión manguera

Latón/acero niquelado o latón niquelado, NBR

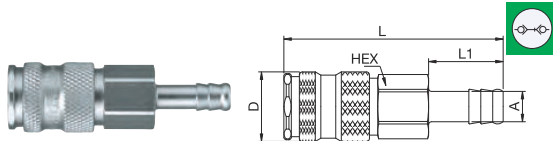

A		HEX	L	L1	D	Versión
6	25KBTf06BPN	19	74	25	23	Latón niquelado
	25KBTf06MPN 9223 25 06	19	74	25	23	Latón/acero niquelado
8	25KBTf08BPN	19	74	25	23	Latón niquelado
	25KBTf08MPN 9223 25 08	19	74	25	23	Latón/acero niquelado
9	25KBTf09BPN	19	74	25	23	Latón niquelado
	25KBTf09MPN	19	74	25	23	Latón/acero niquelado
10	25KBTf10BPN	19	74	25	23	Latón niquelado
	25KBTf10MPN 9223 25 10	19	74	25	23	Latón/acero niquelado
13	25KBTf13BPN	19	74	25	23	Latón niquelado
	25KBTf13MPN 9223 25 13	19	74	25	23	Latón/acero niquelado
10	25KBTp10BPN	19	73	24	23	Latón niquelado
13	25KBTp13BPN	19	76	28	23	Latón niquelado

25KBK0 Enchufe con válvula, con conexión de manguera de plástico

Latón niquelado, NBR

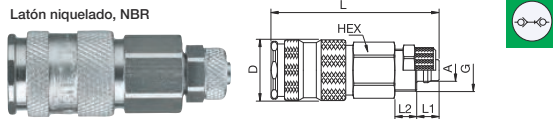

A		HEX	G	L	L1	L2	D
6 x 8	25KBK008BPN	19	M12x1	61	7	6	23
8 x 10	25KBK010BPN	19	M16x1	65	9	8	23
9 x 12	25KBK012BPN	19	M16x1	65	9	8	23

25KBTs Enchufe con válvula, montaje en panel con manguera

Latón niquelado, NBR

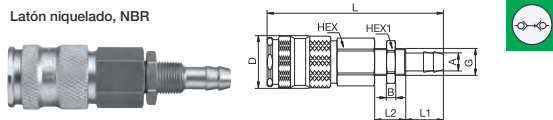

A		HEX	HEX1	B	G	L	L1	L2	D
8	25KBTs08BPN	19	17	4	M12x1	80	17	14	23
10	25KBTs10BPN	19	17	4	M12x1	76	17	10	23

Serie 25 - Latón / Acero

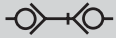

Doble obturación

25KBKK Enchufe con válvula, conexión de manguera plástica con protector de resorte

Latón niquelado, NBR

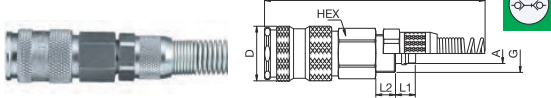

A		HEX	G	L	L1	L2	D
6 x 8	25KBKK08BPN	19	M12x1	144	7	6	23
8 x 10	25KBKK10BPN	19	M16x1	142	7	6	23
9 x 12	25KBKK12BPN	19	M16x1	162	9	8	23

25SBA Acoplador con válvula, rosca macho

Latón niquelado, NBR

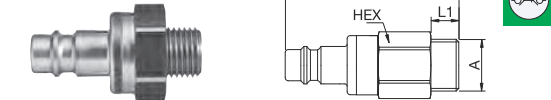

A		HEX	L	L1	
G1/8	25SBAW10MPN	9287 25 10	22	44,5	9
G1/4	25SBAW13MPN	9287 25 13	22	43	9
G3/8	25SBAW17MPN	9287 25 17	22	43	9
G1/2	25SBAW21MPN	9287 25 21	22	46	12
M14 x 1,5	25SBAD14MPN		22	44	10
M16 x 1,5	25SBAD16MPN		22	45	11
M18 x 1,5	25SBAD18MPN		22	45	11

25SBIW Acoplador con válvula, rosca hembra

Latón niquelado, NBR

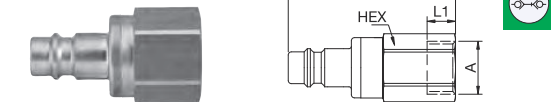

A		HEX	L	L1	
G1/4	25SBIW13MPN	9286 25 13	22	43	10
G3/8	25SBIW17MPN	9286 25 17	22	43	9
G1/2	25SBIW21MPN	9286 25 21	24	46	12



Doble obturación

25SBT Acoplador con válvula, conexión manguera

Latón niquelado, NBR

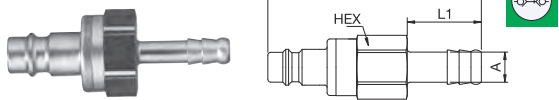

A		HEX	L	L1	
6	25SBTF06MPN	9285 25 06	21	60	25
8	25SBTF08MPN	9285 25 08	21	60	25
9	25SBTF09MPN		21	60	25
10	25SBTF10MPN	9285 25 10	21	60	25
13	25SBTF13MPN	9285 25 13	21	60	25
10	25SBTP10MPN		19	71	24
13	25SBTP13MPN		19	83	28

25SBKO Acoplador con válvula, con conexión de manguera de plástico

Latón niquelado, NBR

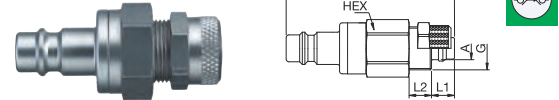

A		HEX	G	L	L1	L2
4 x 6	25SBK006MPN	21	M10x1	47	7	6
6 x 8	25SBK008MPN	21	M12x1	47	7	6
8 x 10	25SBK010MPN	21	M16x1	51	8,5	8,5
9 x 12	25SBK012MPN	21	M16x1	51	8,5	8,5

25SBTS Acoplador con válvula, montaje en panel con manguera

Latón niquelado, NBR

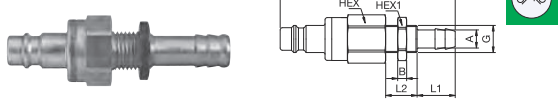

A		HEX	HEX1	B	G	L	L1	L2
8	25SBTS08MPN	21	17	4	M12x1	65	17	14
10	25SBTS10MPN	21	17	3,5	G1/4	74	25	14

25SBKK Acoplador sin válvula, conexión manguera elástica muelle protector

Latón niquelado, NBR

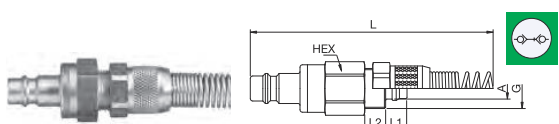

A		HEX	G	L	L1	L2
4 x 6	25SBKK06MPN	19	M10x1	120	7	6
6 x 8	25SBKK08MPN	19	M12x1	135	7	6
8 x 10	25SBKK10MPN	19	M16x1	145	8,5	8,5
9 x 12	25SBKK12MPN	19	M16x1	150	8,5	8,5

Serie 1600 - Latón / Acero

Diámetro nominal
7,8 = 48 mm²



energy
saver



Enchufe automático industrial de primera calidad de 3/8" con perfil estándar europeo. Adecuado para aplicaciones de aire comprimido con un consumo de aire superior a la media. Sistema de enchufe automático con operación de una sola mano. Válvula de caudal ultra alto para un flujo óptimo y una baja caída de presión.

- Disponible a petición:
 - con conexiones finales adicionales
 - otras juntas para diferentes rangos de temperatura y fluidos

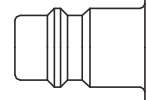

Perfil de Euro

Protecciones contra el polvo (P. 357)
para acoplar la pieza-No. SK23S
para enchufe la pieza-No. SK12S



Simple obturación

Presión de trabajo*:
hasta 35 bar

Material:

- Enchufe: Latón niquelado / Acero tratado con QPQ
- Acoplador: Acero zincado
- Junta: NBR

Temperatura de trabajo:

-20°C hasta +100°C (NBR)

Caudal de aire:

2.020 l/min.
presión de entrada 6 bar, caída de presión 0,5 bar

Caudal de agua:

27 l/min.
caída de presión de 0,5 bar

* máxima presión estática de trabajo con un factor de diseño de 4 a 1.



Simple obturación

1600KAAK Enchufe con válvula, rosca macho

Latón niquelado, acero tratado con QPQ, NBR

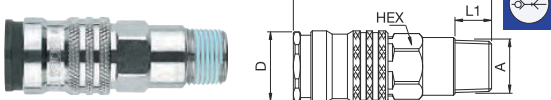

A	HEX	L	L1	D
R1/4	1600KAAK13SPN	19	65	12 23
R3/8	1600KAAK17SPN	19	65	12 23
R1/2	1600KAAK21SPN	22	59,5	17 23

1600KAIW Enchufe con válvula, rosca hembra

Latón niquelado, acero tratado con QPQ, NBR

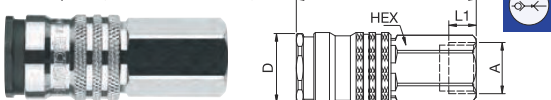

A	HEX	L	L1	D
G1/4	1600KAIW13SPN	19	59	9 23
G3/8	1600KAIW17SPN	19	59	9 23
G1/2	1600KAIW21SPN	24	62	12 23



Simple obturación

1600KATF Enchufe con válvula, conexión manguera

Latón niquelado, acero tratado con QPQ, NBR

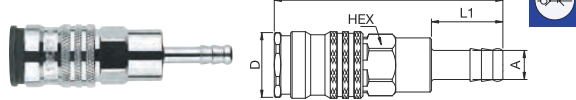

A	HEX	L	L1	D
6	1600KATF06SPN	19	80	25 23
8	1600KATF08SPN	19	80	25 23
9	1600KATF09SPN	19	80	25 23
10	1600KATF10SPN	19	80	25 23
13	1600KATF13SPN	19	80	25 23

Serie 1600 - Latón / Acero

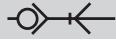

Simple obturación

25SFA Acoplador sin válvula, rosca macho

Acero zincado

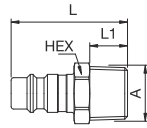

A			HEX	L	L1
R1/8	25SFAK10SXZ		13	33	9
G1/8	25SFAW10SXZ	9087 25 10	13	30,5	6,5
R1/4	25SFAK13SXZ		14	36,5	12
G1/4	25SFAW13SXZ	9087 25 13	17	32,5	8
R3/8	25SFAK17SXZ		17	37	12
G3/8	25SFAW17SXZ	9087 25 17	19	34	9
R1/2	25SFAK21SXZ		22	43	17
G1/2	25SFAW21SXZ	9087 25 21	24	37,5	10,5

25SFIW Acoplador sin válvula, rosca hembra

Acero zincado

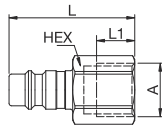

A			HEX	L	L1
G1/8	25SFIW10SXZ	9086 25 10	14	30	5
G1/4	25SFIW13SXZ	9086 25 13	17	38,5	12
G3/8	25SFIW17SXZ	9086 25 17	19	39,5	12
G1/2	25SFIW21SXZ	9086 25 21	24	44	14

25SFTF Acoplador sin válvula, conexión manguera

Acero zincado

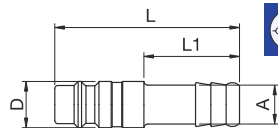

A			L	L1	D
6	25SFTF06SXZ	9085 25 06	48	25	12
8	25SFTF08SXZ	9085 25 08	48	25	12
9	25SFTF09SXZ	9085 25 09	48	25	12
10	25SFTF10SXZ	9085 25 10	48	25	12
13	25SFTF13SXZ	9085 25 13	48	25	15

Serie 1625 - Latón / Acero

Diámetro nominal
7,8 = 48 mm²



energy
saver

Enchufe automático industrial de primera calidad de 3/8" con perfil estándar europeo. Adecuado para aplicaciones de aire comprimido con un consumo de aire superior a la media. Sistema de enchufe automático con operación de una sola mano. Válvula de caudal ultra alto para un flujo óptimo y una baja caída de presión. Manguito de plástico de 2 componentes, extremadamente robusto y de forma ergonómica.

- Disponible a petición:
 - con conexiones finales adicionales
 - otras juntas para diferentes rangos de temperatura y fluidos

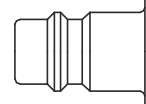

Perfil de Euro

Protecciones contra el polvo (P. 357)
para acoplar la pieza-No. SK23S
para enchufe la pieza-No. SK12S



Simple obturación

Presión de trabajo*:
hasta 35 bar

Material:

- Enchufe: Latón niquelado, acero tratado con QPQ, PA6+TPE
- Acoplador: Acero zincado
- Junta: NBR

Temperatura de trabajo:
-20°C hasta +100°C (NBR)

Caudal de aire:

2.020 l/min.
presión de entrada 6 bar, caída de presión 0,5 bar

Caudal de agua:

31 l/min.
caída de presión de 0,5 bar

* máxima presión estática de trabajo con un factor de diseño de 4 a 1.



Simple obturación

1625KAAK Enchufe con válvula, rosca macho

Latón niquelado, acero tratado con QPQ, PA6+TPE, NBR

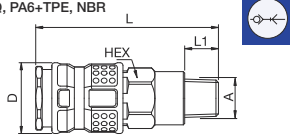

A	HEX	L	L1	D	
R1/4	1625KAAK13SPN	19	65	12	26
R3/8	1625KAAK17SPN	19	65	12	26
R1/2	1625KAAK21SPN	22	59,5	17	26

1625KAIW Enchufe con válvula, rosca hembra

Latón niquelado, acero tratado con QPQ, PA6+TPE, NBR

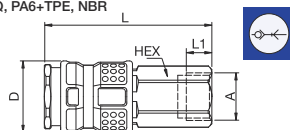

A	HEX	L	L1	D	
G1/4	1625KAIW13SPN	19	59	9	26
G3/8	1625KAIW17SPN	19	59	9	26
G1/2	1625KAIW21SPN	24	62	12	26



Simple obturación

1625KATF Enchufe con válvula, conexión manguera

Latón niquelado, acero tratado con QPQ, PA6+TPE, NBR

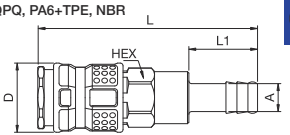

A	HEX	L	L1	D	
6	1625KATF06SPN	19	80	25	26
8	1625KATF08SPN	19	80	25	26
9	1625KATF09SPN	19	80	25	26
10	1625KATF10SPN	19	80	25	26
13	1625KATF13SPN	19	80	25	26

Serie 1625 - Latón / Acero



Simple obturación

25SFA Acoplador sin válvula, rosca macho

Acero zincado

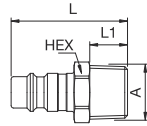

A			HEX	L	L1
R1/8	25SFAK10SXZ		13	33	9
G1/8	25SFAW10SXZ	9087 25 10	13	30,5	6,5
R1/4	25SFAK13SXZ		14	36,5	12
G1/4	25SFAW13SXZ	9087 25 13	17	32,5	8
R3/8	25SFAK17SXZ		17	37	12
G3/8	25SFAW17SXZ	9087 25 17	19	34	9
R1/2	25SFAK21SXZ		22	43	17
G1/2	25SFAW21SXZ	9087 25 21	24	37,5	10,5

25SFIW Acoplador sin válvula, rosca hembra

Acero zincado

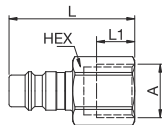

A			HEX	L	L1
G1/8	25SFIW10SXZ	9086 25 10	14	30	5
G1/4	25SFIW13SXZ	9086 25 13	17	38,5	12
G3/8	25SFIW17SXZ	9086 25 17	19	39,5	12
G1/2	25SFIW21SXZ	9086 25 21	24	44	14

25SFTF Acoplador sin válvula, conexión manguera

Acero zincado

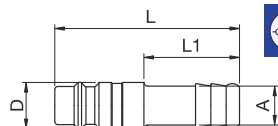

A			L	L1	D
6	25SFTF06SXZ	9085 25 06	48	25	12
8	25SFTF08SXZ	9085 25 08	48	25	12
9	25SFTF09SXZ	9085 25 09	48	25	12
10	25SFTF10SXZ	9085 25 10	48	25	12
13	25SFTF13SXZ	9085 25 13	48	25	15

Serie 33 - Latón / Acero

Diámetro nominal
8 = 50 mm²



Enchufe automático industrial de acero con perfil de Atlas Copco. Especialmente adecuado para su uso con medios gaseosos en la industria. Sistema de enchufe automático con manejo con una sola mano. Válvula de alto caudal para un flujo óptimo y una baja caída de presión.

- Disponible a petición:
 - con conexiones finales adicionales
 - otras juntas para diferentes rangos de temperatura y fluidos

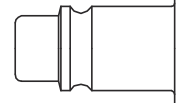

Perfil escandinavo

Protecciones contra el polvo (P. 357)
para acoplar la pieza-No. SK23S
para enchufe la pieza-No. SK12S



Presión de trabajo*:
hasta 35 bar

Material:

- Enchufe: Latón / acero niquelado
- Acoplador: Acero niquelado
- Junta: NBR

Temperatura de trabajo:
-20°C hasta +100°C (NBR)

Caudal de aire:

1.700 l/min.
presión de entrada 6 bar, caída de presión 0,5 bar

Caudal de agua:

23 l/min.
caída de presión de 0,5 bar

* máxima presión estática de trabajo con un factor de diseño de 4 a 1.

 Simple obturación

33KAAK Enchufe con válvula, rosca macho

Latón/acero niquelado, NBR

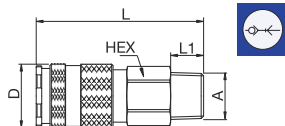
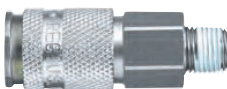

A	HEX	L	L1	D
R1/4 33KAAK13SPN	19	60	12	23
R3/8 33KAAK17SPN	19	59	12	23
R1/2 33KAAK21SPN	22	60	17	23

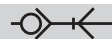
 Simple obturación

33KATF Enchufe con válvula, conexión manguera

Latón/acero niquelado, NBR

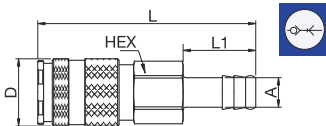

A	HEX	L	L1	D
6 33KATF06SPN	19	73	25	23
8 33KATF08SPN	19	73	25	23
10 33KATF10SPN	19	73	25	23
13 33KATF13SPN	19	73	25	23

33KAIW Enchufe con válvula, rosca hembra

Latón/acero niquelado, NBR

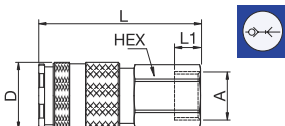

A	HEX	L	L1	D
G1/4 33KAIW13SPN	19	55	10	23
G3/8 33KAIW17SPN	19	54	9	23
G1/2 33KAIW21SPN	24	57	12	23

Serie 33 - Latón / Acero

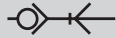

Simple obturación

33SFAK Acoplador sin válvula, rosca macho

Acero niquelado

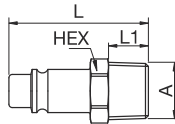

A	HEX	L	L1
R1/4 33SFAK13SXN	14	42	12
R3/8 33SFAK17SXN	17	42	12
R1/2 33SFAK21SXN	22	47	17

33SFIW Acoplador sin válvula, rosca hembra

Acero niquelado

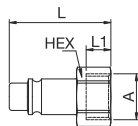

A	HEX	L	L1
G1/4 33SFIW13SXN	17	37	9
G3/8 33SFIW17SXN	17	37	9
G1/2 33SFIW21SXN	24	42	12

33SFTF Acoplador sin válvula, conexión manguera

Acero niquelado

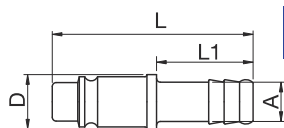

A	L	L1	D
6 33SFTF06SXN	52	25	14
8 33SFTF08SXN	52	25	14
10 33SFTF10SXN	52	25	15
13 33SFTF13SXN	52	25	15

Serie 30 - Latón / Acero

Diámetro nominal
8,5 = 60 mm²



Enchufe automático de acero de 3/8" según ISO 6150 B y US MIL-SPEC 4109. Diseño muy robusto con cuerpos de válvula de acero. La alta profundidad de inserción está garantizada por una guía de enchufe optimizada.

- Disponible a petición:

- en material de latón con recubrimiento de níquel
- con conexiones finales adicionales
- otras juntas para diferentes rangos de temperatura y fluidos

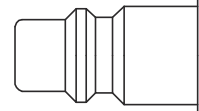

Perfil ISO 6150 B



Simple obturación

Presión de trabajo*:
hasta 35 bar

Material:

- Enchufe: Latón / Acero
- Acoplador: Acero niquelado
- Junta: NBR

Temperatura de trabajo:
-20°C hasta +100°C (NBR)

Caudal de aire:

1.050 l/min.
presión de entrada 6 bar, caída de presión 0,5 bar

Caudal de agua:

14 l/min.
caída de presión de 0,5 bar

* máxima presión estática de trabajo con un factor de diseño de 4 a 1.



Simple obturación

30KAAW Enchufe con válvula, rosca macho

Latón/acero, NBR

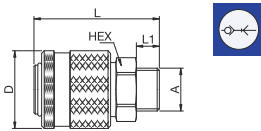

A	HEX	L	L1	D
G1/4 30KAAW13SPX	22	49	9	30
G3/8 30KAAW17SPX	22	49	9	30
G1/2 30KAAW21SPX	22	52	12	30



Simple obturación

30KATF Enchufe con válvula, conexión manguera

Latón/acero, NBR

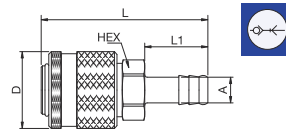
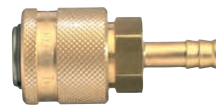

A	HEX	L	L1	D
6 30KATF06SPX	21	66	25	30
8 30KATF08SPX	21	66	25	30
10 30KATF10SPX	21	66	25	30
13 30KATF13SPX	21	66	25	30

30KAIW Enchufe con válvula, rosca hembra

Latón/acero, NBR

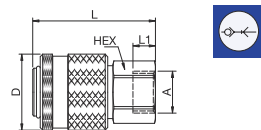
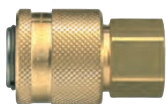

A	HEX	L	L1	D
G1/4 30KAIW13SPX	22	49	11	30
G3/8 30KAIW17SPX	22	49	9	30
G1/2 30KAIW21SPX	22	52	12	30

Serie 30 - Latón / Acero



Simple obturación

30SFAW Acoplador sin válvula, rosca macho

Acero niquelado

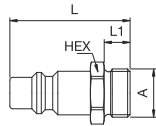

A			HEX	L	L1
G1/4	30SFAW13SXN	9087 30 13	17	42	9
G3/8	30SFAW17SXN	9087 30 17	19	42	9
G1/2	30SFAW21SXN	9087 30 21	24	46	12

30SFIW Acoplador sin válvula, rosca hembra

Acero niquelado

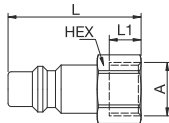

A			HEX	L	L1
G1/4	30SFIW13SXN	9086 30 13	17	40	10
G3/8	30SFIW17SXN	9086 30 17	19	42	10
G1/2	30SFIW21SXN	9086 30 21	24	43	12

30SFTF Acoplador sin válvula, conexión manguera

Acero niquelado

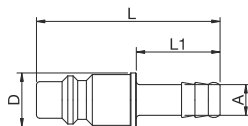

A			L	L1	D
8	30SFTF08SXN	9085 30 08	55	25	16
10	30SFTF10SXN	9085 30 10	55	25	16
13	30SFTF13SXN	9085 30 13	55	25	16

Serie 40 - Latón / Acero

Diámetro nominal
9 = 63 mm²



Sistema de enchufe automático de latón producido para aplicaciones duras. El sistema es adecuado para su uso con medios líquidos no agresivos. Los enchufes automáticos son resistentes a la corrosión. Sistema de enchufe automático con manejo con una sola mano. El diseño ergonómico del manguito evita la entrada de suciedad en el cuerpo de la válvula.

- Disponible a petición:

- en material de latón sin niquelado
- con conexiones finales adicionales
- otras juntas para diferentes rangos de temperatura y fluidos

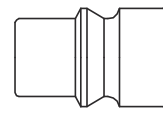

Perfil de ARO



Presión de trabajo*:
hasta 35 bar

Material:

- Enchufe: Latón niquelado
- Acoplador: Latón niquelado
- Junta: NBR

Temperatura de trabajo:
-20°C hasta +100°C (NBR)

Caudal de aire:

1.400 l/min.
presión de entrada 6 bar, caída de presión 0,5 bar

Caudal de agua:

18 l/min.
caída de presión de 0,5 bar

* máxima presión estática de trabajo con un factor de diseño de 4 a 1.

 Simple obturación

40KAIW Enchufe con válvula, rosca hembra

Latón niquelado, NBR

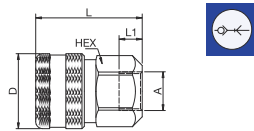

A	HEX	L	L1	D	
G3/8	40KAIW17MPN	27	46	10	32
G1/2	40KAIW21MPN	27	46	11	32

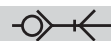
 Simple obturación

40SFIW Acoplador sin válvula, rosca hembra

Acero niquelado

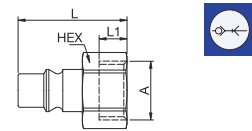
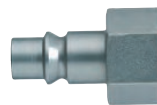

A	HEX	L	L1	
G3/8	40SFIW17SXN	19	35	9
G1/2	40SFIW21SXN	24	39	12

40SFAK Acoplador sin válvula, rosca macho

Acero niquelado

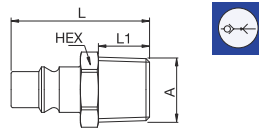

A	HEX	L	L1	
R3/8	40SFAK17SXN	16	40	12
R1/2	40SFAK21SXN	16	46	17

40SFTF Acoplador sin válvula, conexión manguera

Acero niquelado

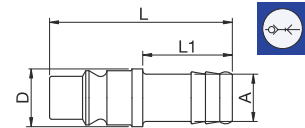

A	L	L1	D	
8	40SFTF08SXN	51	25	16
10	40SFTF10SXN	51	25	16
13	40SFTF13SXN	51	25	16

Serie 27 - Latón / Acero

Diámetro nominal
10 = 80 mm²



Enchufe automático industrial universal de 1/2" con perfil europeo estándar para su uso con grandes consumidores de neumáticos. Sistema de acoplamiento con operación de una sola mano. Válvula de alto caudal para un flujo óptimo y una baja caída de presión. La serie destaca por su robusto diseño (manguito de acero), un caudal extremadamente alto y una larga vida útil incluso con el uso más duro. El diseño del collarín minimiza los daños en el cuerpo de la válvula.

- Disponible a petición:
 - en material de latón con recubrimiento de níquel
 - con conexiones finales adicionales
 - otras juntas para diferentes rangos de temperatura y fluidos

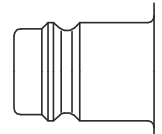

Perfil de Euro

Protecciones contra el polvo (P. 357) para acoplar la pieza-No. SK27S

KA Simple obturación

Presión de trabajo*:
hasta 35 bar

Material:

- Enchufe: Latón / acero niquelado
- Acoplador: Acero niquelado
- Junta: NBR

Temperatura de trabajo:
-20°C hasta +100°C (NBR)

Caudal de aire:

2.400 l/min.
presión de entrada 6 bar, caída de presión 0,5 bar

Caudal de agua:

31 l/min.
caída de presión de 0,5 bar

KB Doble obturación

Presión de trabajo*:
hasta 35 bar

Material:

- Enchufe: Brass
- Acoplador: Latón niquelado
- Junta: NBR

Temperatura de trabajo:
-20°C hasta +100°C (NBR)

Caudal de aire:

950 l/min.
presión de entrada 6 bar, caída de presión 0,5 bar

Caudal de agua:

14 l/min.
caída de presión de 0,5 bar

* máxima presión estática de trabajo con un factor de diseño de 4 a 1.

Simple obturación

Simple obturación

27KAAK Enchufe con válvula, rosca macho

Latón niquelado / Acero, NBR

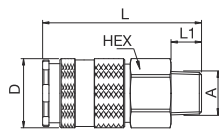

A	HEX	L	L1	D
R1/4	27KAAK13MPN	24	63	12 27
R3/8	27KAAK17MPN	24	63	12 27
R1/2	27KAAK21MPN	24	65	17 27
R3/4	27KAAK26MPN	27	65	17 27

27KAIW Enchufe con válvula, rosca hembra

Latón niquelado / Acero, NBR

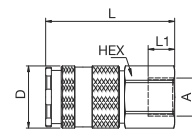

A	HEX	L	L1	D
G1/4	27KAIW13MPN	24	56	10 27
G3/8	27KAIW17MPN	24	56	11 27
G1/2	27KAIW21MPN	24	56	12 27
G3/4	27KAIW26MPN	27	60	16 27

Serie 27 - Latón / Acero



Simple obturación

27KATF Enchufe con válvula, conexión manguera

Latón niquelado / Acero, NBR

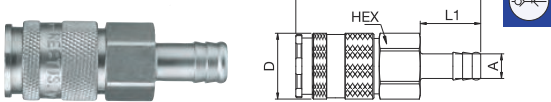

A		HEX	L	L1	D
8	27KATF08MPN	24	76	25	27
9	27KATF09MPN	24	76	25	27
10	27KATF10MPN	24	76	25	27
13	27KATF13MPN	24	76	25	27
16	27KATF16MPN	24	76	20	27
19	27KATF19MPN	24	76	25	27

27SFAK Acoplador sin válvula, rosca macho

Acero niquelado

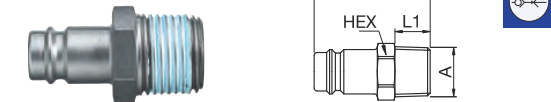

A		HEX	L	L1
R1/4	27SFAK13SXN	17	40	12
R3/8	27SFAK17SXN	17	40	12
R1/2	27SFAK21SXN	22	45	17
R3/4	27SFAK26SXN	27	48	19

27SFIW Acoplador sin válvula, rosca hembra

Acero niquelado



A		HEX	L	L1	
G1/4	27SFIW13SXN	17	33	9	
G3/8	27SFIW17SXN	9086 27 17	19	33	9
G1/2	27SFIW21SXN	9086 27 21	24	37	12
G3/4	27SFIW26SXN	9086 27 27	32	42	16

27SFTF Acoplador sin válvula, conexión manguera

Acero niquelado

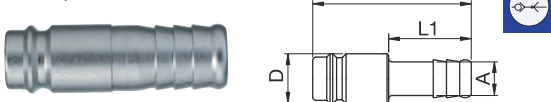

A		L	L1	D	
6	27SFTF06SXN	48	25	15	
8	27SFTF08SXN	9085 27 08	48	25	15
9	27SFTF09SXN	48	25	15	
10	27SFTF10SXN	9085 27 10	48	25	15
13	27SFTF13SXN	9085 27 13	48	25	15
16	27SFTF16SXN	49	25	18	
19	27SFTF19SXN	9085 27 19	49	25	21



Doble obturación

27KBAK Enchufe con válvula, rosca macho

Latón niquelado, NBR

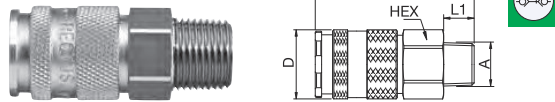

A		HEX	L	L1	D
R1/4	27KBAK13BPN	24	63	12	27
R3/8	27KBAK17BPN	24	63	12	27
R1/2	27KBAK21BPN	24	65	17	27
R3/4	27KBAK26BPN	27	65	17	27

27KBIW Enchufe con válvula, rosca hembra

Latón niquelado, NBR

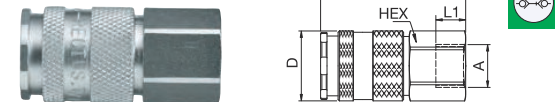

A		HEX	L	L1	D
G1/4	27KBIW13BPN	24	56	10	27
G3/8	27KBIW17BPN	24	56	11	27
G1/2	27KBIW21BPN	24	56	12	27
G3/4	27KBIW26BPN	32	60	16	27

27KBTf Enchufe con válvula, conexión manguera

Latón niquelado, NBR

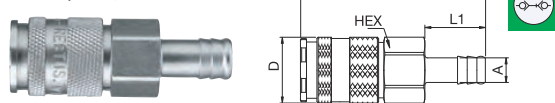

A		HEX	L	L1	D
8	27KBTf08BPN	24	76	25	27
9	27KBTf09BPN	24	76	25	27
10	27KBTf10BPN	24	76	25	27
13	27KBTf13BPN	24	76	25	27
16	27KBTf16BPN	24	76	25	27
19	27KBTf19BPN	24	76	25	27

27SBAK Acoplador con válvula, rosca macho

Latón niquelado, NBR

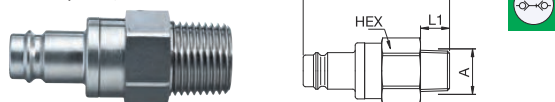

A		HEX	L	L1
R1/4	27SBAK13MPN	24	60,5	12
R3/8	27SBAK17MPN	24	60,5	12
R1/2	27SBAK21MPN	24	62,5	17
R3/4	27SBAK26MPN	27	62,5	17

Serie 27 - Latón / Acero





Doble obturación

27SBIW Acoplador con válvula, rosca hembra

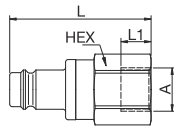
Latón niquelado, NBR





A			HEX	L	L1
G1/4					
	27SBIW13MPN		24	55	9
G3/8	27SBIW17MPN	9286 27 17	24	55	9
G1/2	27SBIW21MPN	9286 27 21	24	55	12
G3/4	27SBIW26MPN	9286 27 27	32	58	16

27SBTF Acoplador con válvula, conexión manguera

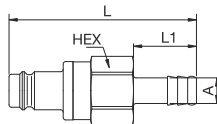
Latón niquelado, NBR



A			HEX	L	L1
8					
	27SBTF08MPN	9285 27 08	24	75	25
9	27SBTF09MPN		24	75	25
10	27SBTF10MPN	9285 27 10	24	75	25
13	27SBTF13MPN	9285 27 13	24	75	25
16	27SBTF16MPN		24	75	25
19	27SBTF19MPN	9285 27 19	24	75	25

Series 1700 - Latón / Acero

Diámetro nominal
10 = 80 mm²



energy
saver

Enchufe automático industrial premium de 1/2" con perfil europeo estándar. Adecuado para aplicaciones de aire comprimido con un consumo de aire superior a la media. Valores de caudal superiores a la media en comparación con los productos estándar del mercado. Sistema de enchufe automático con manejo con una sola mano. Válvula de caudal ultra alto para un flujo óptimo y una baja caída de presión.

- Disponible a petición:

- con conexiones finales adicionales
- otras juntas para diferentes rangos de temperatura y fluidos

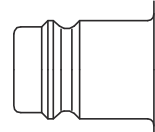

Perfil de Euro

Protecciones contra el polvo (P. 357)
para acoplar la pieza-No. SK27S



Simple obturación

Presión de trabajo*:
hasta 35 bar

Material:

- Enchufe: Latón niquelado, acero tratado QPQ
- Acoplador: Acero niquelado
- Junta: NBR

Temperatura de trabajo:
-20°C hasta +100°C (NBR)

Caudal de aire:

3.500 l/min.
presión de entrada 6 bar, caída de presión 0,5 bar

Caudal de agua:

51 l/min.
caída de presión de 0,5 bar

* máxima presión estática de trabajo con un factor de diseño de 4 a 1.



Simple obturación

1700KAAK Enchufe con válvula, rosca macho

Latón niquelado, acero tratado con QPQ, NBR

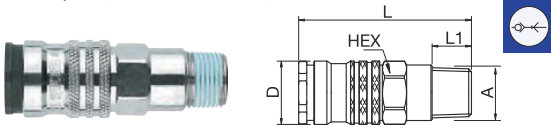

A	HEX	L	L1	D
R3/8	1700KAAK17SPN	24	70	12 27
R1/2	1700KAAK21SPN	24	75	17 27
R3/4	1700KAAK26SPN	27	64	17 27



Simple obturación

1700KATF Enchufe con válvula, conexión manguera

Latón niquelado, acero tratado con QPQ, NBR

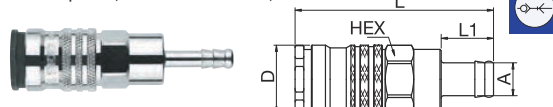

A	HEX	L	L1	D
10	1700KATF10SPN	24	80	21 27
13	1700KATF13SPN	24	80	21 27
16	1700KATF16SPN	24	80	21 27
19	1700KATF19SPN	24	80	21 27

1700KAIW Enchufe con válvula, rosca hembra

Latón niquelado, acero tratado con QPQ, NBR



A	HEX	L	L1	D
G3/8	1700KAIW17SPN	24	64,5	10 27
G1/2	1700KAIW21SPN	24	68	11 27
G3/4	1700KAIW26SPN	32	69	14 27

Serie 1700 - Latón / Acero

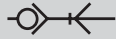

Simple obturación

27SFAK Acoplador sin válvula, rosca macho

Acero niquelado

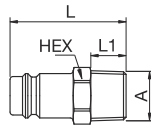

A		HEX	L	L1
R1/4	27SFAK13SXN	17	40	12
R3/8	27SFAK17SXN	17	40	12
R1/2	27SFAK21SXN	22	45	17
R3/4	27SFAK26SXN	27	48	19

27SFIW Acoplador sin válvula, rosca hembra

Acero niquelado

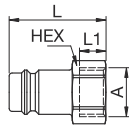

A		HEX	L	L1
G1/4	27SFIW13SXN	17	33	9
G3/8	27SFIW17SXN	9086 27 17	19	33
G1/2	27SFIW21SXN	9086 27 21	24	37
G3/4	27SFIW26SXN	9086 27 27	32	42

27SFTF Acoplador sin válvula, conexión manguera

Acero niquelado

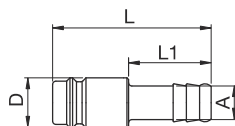

A		L	L1	D
6	27SFTF06SXN	48	25	15
8	27SFTF08SXN	9085 27 08	48	25
9	27SFTF09SXN	48	25	15
10	27SFTF10SXN	9085 27 10	48	25
13	27SFTF13SXN	9085 27 13	48	25
16	27SFTF16SXN	49	25	18
19	27SFTF19SXN	9085 27 19	49	25

Serie 1727 - Latón / Acero

Diámetro nominal
10 = 80 mm²



energy
saver

Enchufe automático industrial premium de 1/2" con perfil europeo estándar. Adecuado para aplicaciones de aire comprimido con un consumo de aire superior a la media. Valores de flujo superiores a la media en comparación con los productos estándar del mercado. Sistema de acoplamiento con manejo con una sola mano. Válvula de caudal ultra alto para un flujo óptimo y una baja caída de presión. Manguito de plástico de 2 componentes extremadamente robusto y de forma ergonómica.

- Disponible a petición:
 - con conexiones finales adicionales
 - otras juntas para diferentes rangos de temperatura y fluidos

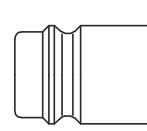

Perfil de Euro

Protecciones contra el polvo (P. 357)
para acoplar la pieza-No. SK27S
para enchufe la pieza-No. SK16S



Simple obturación

Presión de trabajo*:
hasta 35 bar

Material:

- Enchufe: Latón niquelado, acero tratado con QPQ, PA6+TPE
- Acoplador: Acero niquelado
- Junta: NBR

Temperatura de trabajo:
-20°C hasta +40°C (NBR)

Caudal de aire:

3.500 l/min.
presión de entrada 6 bar, caída de presión 0,5 bar

Caudal de agua:

51 l/min.
caída de presión de 0,5 bar

* máxima presión estática de trabajo con un factor de diseño de 4 a 1.



Simple obturación

1727KAAK Enchufe con válvula, rosca macho

Latón niquelado, acero tratado con QPQ, PA6+TPE, NBR

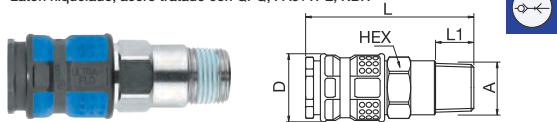

A		HEX	L	L1	D
R3/8	1727KAAK17SPN	24	70	12	30
R1/2	1727KAAK21SPN	24	75	17	30
R3/4	1727KAAK26SPN	27	64	17	30



Simple obturación

1727KATF Enchufe con válvula, conexión manguera

Latón niquelado, acero tratado con QPQ, PA6+TPE, NBR

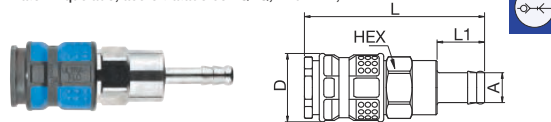

A		HEX	L	L1	D
10	1727KATF10SPN	24	80	21	30
13	1727KATF13SPN	24	80	21	30
16	1727KATF16SPN	24	80	21	30
19	1727KATF19SPN	24	80	21	30

1727KAIW Enchufe con válvula, rosca hembra

Latón niquelado, acero tratado con QPQ, PA6+TPE, NBR

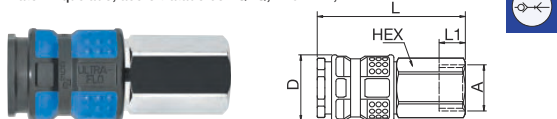

A		HEX	L	L1	D
G3/8	1727KAIW17SPN	24	64,5	10	30
G1/2	1727KAIW21SPN	24	68	12	30
G3/4	1727KAIW26SPN	32	69	14	30

Serie 1727 - Latón / Acero



Simple obturación

27SFAK Acoplador sin válvula, rosca macho

Acero niquelado

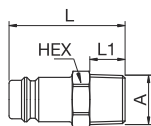

A		HEX	L	L1
R1/4	27SFAK13SXN	17	40	12
R3/8	27SFAK17SXN	17	40	12
R1/2	27SFAK21SXN	22	45	17
R3/4	27SFAK26SXN	27	48	19

27SFIW Acoplador sin válvula, rosca hembra

Acero niquelado

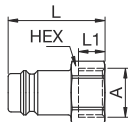

A		HEX	L	L1
G1/4	27SFIW13SXN	17	33	9
G3/8	27SFIW17SXN	9086 27 17	19	33
G1/2	27SFIW21SXN	9086 27 21	24	37
G3/4	27SFIW26SXN	9086 27 27	32	42

27SFTF Acoplador sin válvula, conexión manguera

Acero niquelado

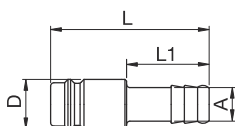

A		L	L1	D
6	27SFTF06SXN	48	25	15
8	27SFTF08SXN	9085 27 08	48	25
9	27SFTF09SXN	48	25	15
10	27SFTF10SXN	9085 27 10	48	25
13	27SFTF13SXN	9085 27 13	48	25
16	27SFTF16SXN	49	25	18
19	27SFTF19SXN	9085 27 19	49	25

Serie 34 - Latón / Acero

Diámetro nominal
10 = 80 mm²



Acoplamiento industrial con perfil de Atlas Copco. Sistema de acoplamiento con operación a una sola mano. Válvula de alto caudal para un flujo óptimo y una baja caída de presión. Óptimo para el uso con grandes consumidores neumáticos debido al diseño robusto y al manguito de acero. El diseño del collar minimiza los daños en el cuerpo de la válvula.

- Disponible a petición:
 - con conexiones finales adicionales
 - otras juntas para diferentes rangos de temperatura y fluidos

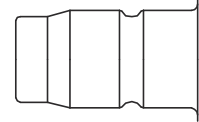

Perfil escandinavo

Protecciones contra el polvo (P. 357)
para acoplar la pieza-No. SK27S



Simple obturación

Presión de trabajo*:
hasta 35 bar

Material:

- Enchufe: Latón / acero niquelado
- Acoplador: Acero niquelado
- Junta: NBR

Temperatura de trabajo:
-20°C hasta +100°C (NBR)

Caudal de aire:

2.550 l/min.
presión de entrada 6 bar, caída de presión 0,5 bar

Caudal de agua:

30 l/min.
caída de presión de 0,5 bar

* máxima presión estática de trabajo con un factor de diseño de 4 a 1.



Simple obturación

34KAAK Enchufe con válvula, rosca macho

Latón/acero niquelado, NBR

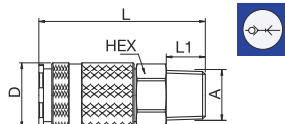

A	HEX	L	L1	D
R3/8	34KAAK17SPN	24	70	12 28
R1/2	34KAAK21SPN	24	72	12 28
R3/4	34KAAK26SPN	27	72	12 28



Simple obturación

34KATF Enchufe con válvula, conexión manguera

Latón/acero niquelado, NBR

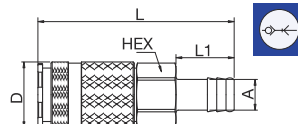
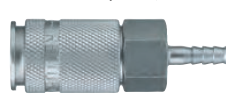

A	HEX	L	L1	D
10	34KATF10SPN	24	84	25 28
13	34KATF13SPN	24	84	25 28
16	34KATF16SPN	24	84	25 28
19	34KATF19SPN	24	84	25 28

34KAIW Enchufe con válvula, rosca hembra

Latón/acero niquelado, NBR

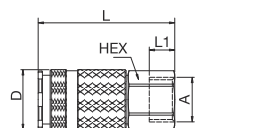

A	HEX	L	L1	D
G3/8	34KAIW17SPN	24	64	12 28
G1/2	34KAIW21SPN	24	64	12 28
G3/4	34KAIW26SPN	32	68,5	14 28

Serie 34 - Latón / Acero

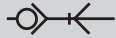

Simple obturación

34SFAK Acoplador sin válvula, rosca macho

Acero niquelado

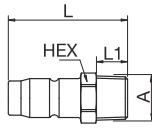

A	HEX	L	L1
R1/4 34SFAK13SXN	17	46	12
R3/8 34SFAK17SXN	19	46	12
R1/2 34SFAK21SXN	22	52	17

34SFIW Acoplador sin válvula, rosca hembra

Acero niquelado

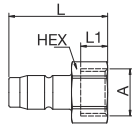

A	HEX	L	L1
G3/8 34SFIW17SXN	19	40	9
G1/2 34SFIW21SXN	24	44	12

34SFTF Acoplador sin válvula, conexión manguera

Acero niquelado

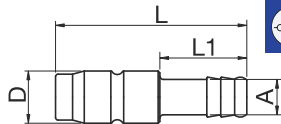

A	L	L1	D
10 34SFTF10SXN	55	25	15
13 34SFTF13SXN	55	25	15

Serie 41 - Latón / Acero

Diámetro nominal
10 = 80 mm²



Acoplamiento de latón sin válvula para aplicaciones con líquidos en el rango de presión de hasta 35 bar. Los enchufes automáticos son resistentes a la corrosión. El sistema destaca por un alto caudal con una mínima caída de presión.

- Disponible a petición:
 - con conexiones finales adicionales
 - otras juntas para diferentes rangos de temperatura y fluidos

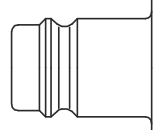

varios perfiles



Presión de trabajo*:
hasta 35 bar

Material:

- Enchufe: Latón niquelado
- Acoplador: Acero niquelado
- Junta: NBR

Temperatura de trabajo:
-20°C hasta +100°C (NBR)

Caudal de agua:
58 l/min.

caída de presión de 0,5 bar

* máxima presión estática de trabajo con un factor de diseño de 4 a 1.

 Sin obturación

41KFAW Enchufe sin válvula, rosca macho

Latón niquelado, NBR

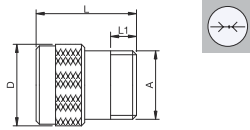

A	L	L1	D
G1/2	31	8	25

41KFAW21MPN

 Sin obturación

41KFTF Enchufe sin válvula, conexión manguera

Latón niquelado, NBR

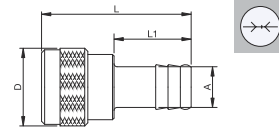
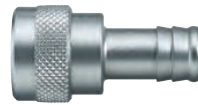

A	L	L1	D
13	48,5	25	25
19	48,5	25	25

41KFTF13MPN
41KFTF19MPN

41KFIW Enchufe sin válvula, rosca hembra

Latón niquelado, NBR

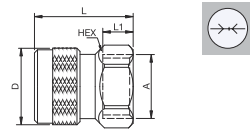

A	HEX	L	L1	D
G1/2	24	32,5	10	25

41KFIW21MPN

41SFAW Acoplador sin válvula, rosca macho

Latón niquelado

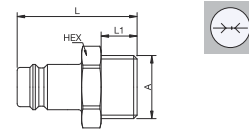

A	HEX	L	L1
G1/2	24	40	12

41SFAW21MXN

Serie 41 - Latón / Acero



Sin obturación

41SFIW Acoplador sin válvula, rosca hembra

Latón niquelado

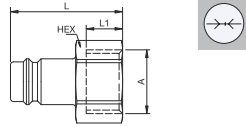
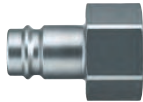

A	HEX	L	L1
G1/2	41SFIW21MXN	24	37 12

41SFTF Acoplador sin válvula, conexión manguera

Latón niquelado

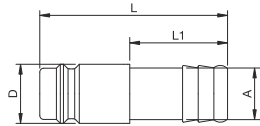

A	L	L1	D
13	41SFTF13MXN	48	25 15
19	41SFTF19MXN	49	25 21

Serie 37 - Latón / Acero

Diámetro nominal
11 = 95 mm²



Sistema de acoplamiento de latón robusto de 1/2" según ISO 6150 B y US MIL-SPEC 4109. Sistema de acoplamiento con una sola mano. La alta profundidad de inserción se garantiza por una guía de enchufe optimizada.

- Disponible a petición:
 - con conexiones finales adicionales
 - otras juntas para diferentes rangos de temperatura y fluidos

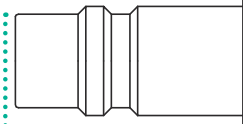

Perfil ISO 6150 B

Protecciones contra el polvo (P. 357)
para acoplar la pieza-No. SK27S
para enchufe la pieza-No. SK16S



Simple obturación

Presión de trabajo*:
hasta 35 bar

Material:

- Enchufe: Latón / acero niquelado
- Acoplador: Acero niquelado
- Junta: NBR

Temperatura de trabajo:
-20°C hasta +100°C (NBR)

Caudal de aire:

2.600 l/min.
presión de entrada 6 bar, caída de presión 0,5 bar

Caudal de agua:

33 l/min.
caída de presión de 0,5 bar

* máxima presión estática de trabajo con un factor de diseño de 4 a 1.



Simple obturación

37KAAW Enchufe con válvula, rosca macho

Latón, NBR

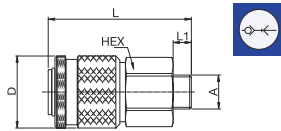
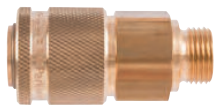

A	HEX	L	L1	D
G1/2	37KAAW21MPX	30	76,5	12 35



Simple obturación

37KATF Enchufe con válvula, conexión manguera

Latón, NBR

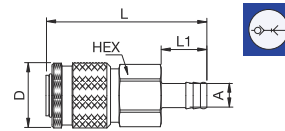

A	HEX	L	L1	D
13	37KATF13MPX	30	86	25 35
19	37KATF19MPX	30	86	25 35

37KAIW Enchufe con válvula, rosca hembra

Latón, NBR

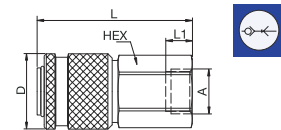
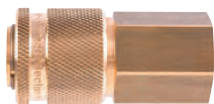

A	HEX	L	L1	D
G1/2	37KAIW21MPX	30	73	10 35

Serie 37 - Latón / Acero

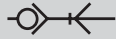

Simple obturación

37SFAK Acoplador sin válvula, rosca macho

Acero niquelado

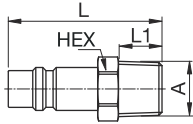

A	HEX	L	L1
R1/2 37SFAK21SXN	22	60	17

37SFIW Acoplador sin válvula, rosca hembra

Acero niquelado

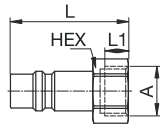

A	HEX	L	L1
G1/2 37SFIW21SXN	24	50	10

37SFTF Acoplador sin válvula, conexión manguera

Acero niquelado

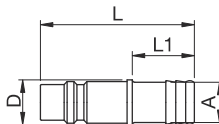

A	L	L1	D
13 37SFTF13SXN	62	25	17
16 37SFTF16SXN	62	25	18
19 37SFTF19SXN	72	35	21

Serie 57 - Latón / Acero

Diámetro nominal
11 = 95 mm²



Perfil industrial alemán para aplicaciones de aire comprimido. Válvula de alto caudal para un flujo óptimo y una baja caída de presión. Estructura robusta, optimizada en cuanto a tamaño y rendimiento. El diseño del cuello minimiza los daños en el cuerpo de la válvula.

- Disponible a petición:
 - con conexiones finales adicionales
 - otras juntas para diferentes rangos de temperatura y fluidos

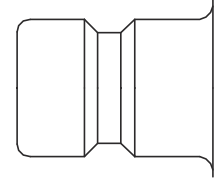

Perfil alemán



Simple obturación

Presión de trabajo*:
hasta 35 bar

Material:

- Enchufe: Latón niquelado
- Acoplador: Acero niquelado
- Junta: NBR

Temperatura de trabajo:
-20°C hasta +100°C (NBR)

Caudal de aire:

6.500 l/min.
presión de entrada 6 bar, caída de presión 0,5 bar

Caudal de agua:

65 l/min.
caída de presión de 0,5 bar



Doble obturación

Presión de trabajo*:
hasta 35 bar

Material:

- Enchufe: Latón niquelado
- Acoplador: Latón niquelado
- Junta: NBR

Temperatura de trabajo:
-20°C hasta +100°C (NBR)

Caudal de aire:

4.300 l/min.
presión de entrada 6 bar, caída de presión 0,5 bar

Caudal de agua:

52 l/min.
caída de presión de 0,5 bar

* máxima presión estática de trabajo con un factor de diseño de 4 a 1.



Simple obturación/Doble obturación

57KBAW Enchufe con válvula, rosca macho

Latón niquelado, NBR

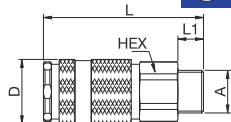
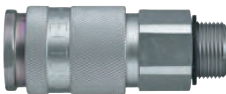

A	HEX	L	L1	D
G1/2	57KBAW21BPN	34	98	12 40
G3/4	57KBAW26BPN	34	100	16 40



Simple obturación

57SFAW Acoplador sin válvula, rosca macho

Acero niquelado

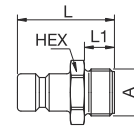

A	HEX	L	L1
G1/2	57SFAW21SXN	27	52 15

57KBIW Enchufe con válvula, rosca hembra

Latón niquelado, NBR

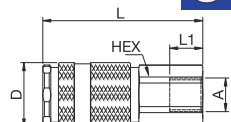

A	HEX	L	L1	D
G1/2	57KBIW21BPN	34	100	19 40
G3/4	57KBIW26BPN	34	100	16 40

57SFIW Acoplador sin válvula, rosca hembra

Acero niquelado

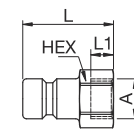

A	HEX	L	L1
G1/2	57SFIW21SXN	27	48 15

Serie 57 - Latón / Acero

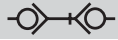

Doble obturación

57SBAW Acoplador con válvula, rosca macho

Latón niquelado, NBR

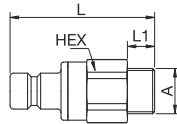
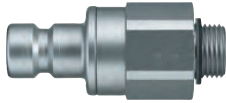

A		HEX	L	L1
G1/2	57SBAW21MPN	34	83	12
G3/4	57SBAW26MPN	34	85	16

57SBIW Acoplador con válvula, rosca hembra

Latón niquelado, NBR

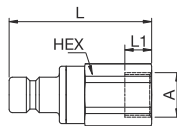
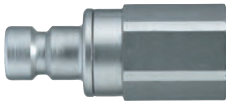

A		HEX	L	L1
G1/2	57SBIW21MPN	34	85	19
G3/4	57SBIW26MPN	34	85	16

Serie 38 - Latón / Acero

Diámetro nominal
15 = 175 mm²



Sistema de acoplamiento industrial compacto en latón para su uso con numerosos medios gaseosos y líquidos. Válvula de alto caudal para un flujo óptimo y una baja caída de presión.

- Disponible a petición:
 - con conexiones finales adicionales
 - otras juntas para diferentes rangos de temperatura y fluidos

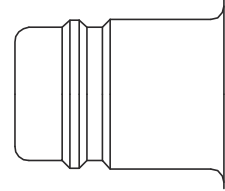

Perfil Americano

KA Simple obturación

Presión de trabajo*:
hasta 35 bar

Material:

- Enchufe: Latón niquelado
- Acoplador: Latón niquelado
- Junta: NBR

Temperatura de trabajo:
-20°C hasta +100°C (NBR)

Caudal de aire:

7.500 l/min.
presión de entrada 6 bar, caída de presión 0,5 bar

Caudal de agua:

96 l/min.
caída de presión de 0,5 bar

KB Doble obturación

Presión de trabajo*:
hasta 35 bar

Material:

- Enchufe: Latón niquelado
- Acoplador: Latón niquelado
- Junta: NBR

Temperatura de trabajo:
-20°C hasta +100°C (NBR)

Caudal de aire:

2.150 l/min.
presión de entrada 6 bar, caída de presión 0,5 bar

Caudal de agua:

27 l/min.
caída de presión de 0,5 bar

* máxima presión estática de trabajo con un factor de diseño de 4 a 1.



Simple obturación/Doble obturación

38KBAW Enchufe con válvula, rosca macho

Latón niquelado, NBR

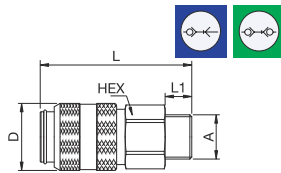

A	HEX	L	L1	D	
G1/2	38KBAW21MPN	34	89	12	40
G3/4	38KBAW26MPN	34	91	16	40
G1	38KBAW33MPN	41	91	19	40

38KBIW Enchufe con válvula, rosca hembra

Latón niquelado, NBR

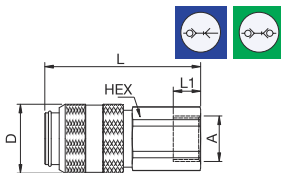

A	HEX	L	L1	D	
G1/2	38KBIW21MPN	34	95	20	40
G3/4	38KBIW26MPN	34	91	14	40
G1	38KBIW33MPN	41	92	20	40



Simple obturación/Doble obturación

38KBTf Enchufe con válvula, conexión manguera

Latón niquelado, NBR

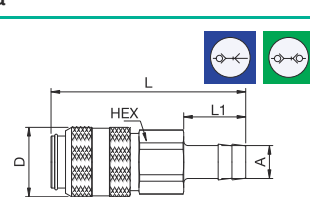

A	HEX	L	L1	D	
13	38KBTf13MPN	34	105	28	40
19	38KBTf19MPN	34	113	36	40

Serie 38 - Latón / Acero



Simple obturación

38SFAW Acoplador sin válvula, rosca macho

Latón niquelado

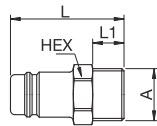

A		HEX	L	L1
G1/2	38SFAW21MXN	24	54	12
G3/4	38SFAW26MXN	27	58	16
G1	38SFAW33MXN	36	63	19

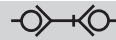

Doble obturación

38SBAW Acoplador con válvula, rosca macho

Latón niquelado, NBR

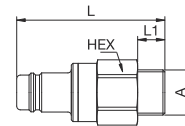

A		HEX	L	L1
G1/2	38SBAW21MPN	34	85	12
G3/4	38SBAW26MPN	34	87	16
G1	38SBAW33MPN	41	87	19

38SFIW Acoplador sin válvula, rosca hembra

Latón niquelado

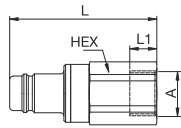

A		HEX	L	L1
G1/2	38SFIW21MXN	24	49	12
G3/4	38SFIW26MXN	30	54	18
G1	38SFIW33MXN	41	61	24

38SBIW Acoplador con válvula, rosca hembra

Latón niquelado, NBR

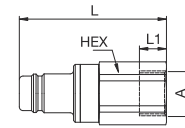

A		HEX	L	L1
G1/2	38SBIW21MPN	34	87	16
G3/4	38SBIW26MPN	34	87	16
G1	38SBIW33MPN	41	88	26

38SFTF Acoplador sin válvula, conexión manguera

Latón niquelado

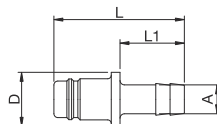

A		L	L1	D
13	38SFTF13MXN	65	28	30
19	38SFTF19MXN	73	36	30

38SBTF Acoplador con válvula, conexión manguera

Latón niquelado, NBR

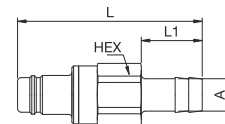

A		HEX	L	L1
13	38SBTF13MPN	34	103	28
19	38SBTF19MPN	34	109	36

Serie 39 - Latón / Acero

Diámetro nominal
19 = 300 mm²



Sistema de acoplador industrial compacto en latón para su uso con numerosos medios gaseosos y líquidos. Válvula de alto caudal para un flujo óptimo y una baja caída de presión.

- Disponible a petición:
 - con conexiones finales adicionales
 - otras juntas para diferentes rangos de temperatura y fluidos

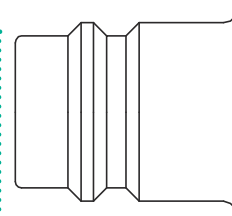

Perfil Americano

KA Simple obturación

Presión de trabajo*:
hasta 35 bar

Material:

- Enchufe: Latón niquelado
- Acoplador: Latón niquelado
- Junta: NBR

Temperatura de trabajo:
-20°C hasta +100°C (NBR)

Caudal de aire:
9.000 l/min.
presión de entrada 6 bar, caída de presión 0,5 bar

Caudal de agua:
125 l/min.
caída de presión de 0,5 bar

KB Doble obturación

Presión de trabajo*:
hasta 35 bar

Material:

- Enchufe: Latón niquelado
- Acoplador: Latón niquelado
- Junta: NBR

Temperatura de trabajo:
-20°C hasta +100°C (NBR)

Caudal de aire:
3.000 l/min.
presión de entrada 6 bar, caída de presión 0,5 bar

Caudal de agua:
33 l/min.
caída de presión de 0,5 bar

KL Doble obturación sin goteo

Presión de trabajo*:
hasta 8 bar

Material:

- Enchufe: Latón niquelado
- Acoplador: Latón niquelado
- Junta: NBR

Temperatura de trabajo:
-20°C hasta +100°C (NBR)

Caudal de agua:
33 l/min.
caída de presión de 0,5 bar

* máxima presión estática de trabajo con un factor de diseño de 4 a 1.

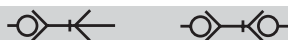

Simple obturación / Doble obturación

39KBAW Enchufe con válvula, rosca macho

Latón niquelado, NBR

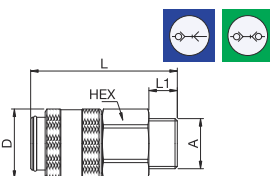

A	HEX	L	L1	D	
G3/4	39KBAW26MPN	41	95	16	46
G1	39KBAW33MPN	41	98	19	46



Simple obturación / Doble obturación

39KBTf Enchufe con válvula, conexión manguera

Latón niquelado, NBR

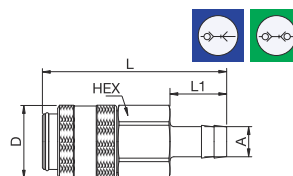
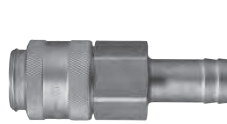

A	HEX	L	L1	D	
19	39KBTf19MPN	41	115	36	46
25	39KBTf25MPN	41	125	48	46

39KBIW Enchufe con válvula, rosca hembra

Latón niquelado, NBR

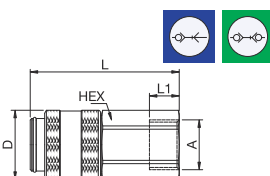

A	HEX	L	L1	D	
G3/4	39KBIW26MPN	41	99	20	46
G1	39KBIW33MPN	41	100	20	46

Serie 39 - Latón / Acero



Simple obturación

39SFAW Acoplador sin válvula, rosca macho

Latón niquelado

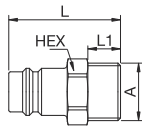

A	HEX	L	L1	
G3/4	39SFAW26MXN	30	60	16
G1	39SFAW33MXN	34	65	19



Doble obturación

39SBTF Acoplador con válvula, conexión manguera

Latón niquelado, NBR

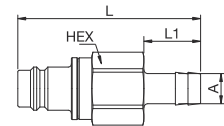

A	HEX	L	L1	
19	39SBTF19MPN	41	114	36
25	39SBTF25MPN	41	124	48

39SFIW Acoplador sin válvula, rosca hembra

Latón niquelado

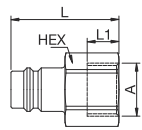

A	HEX	L	L1	
G1	39SFIW33MXN	41	68	24



Sin goteo

39KLAW Enchufe con válvula, rosca macho

Latón niquelado, NBR

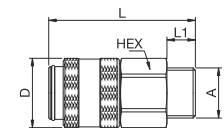

A	HEX	L	L1	D	
G3/4	39KLAW26MPN	41	95	16	46
G1	39KLAW33MPN	41	98	19	46

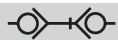

Doble obturación

39SBAW Acoplador con válvula, rosca macho

Latón niquelado, NBR

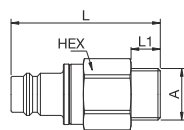

A	HEX	L	L1	
G3/4	39SBAW26MPN	41	92	16
G1	39SBAW33MPN	41	95	19

39KLIW Enchufe con válvula, rosca hembra

Latón niquelado, NBR

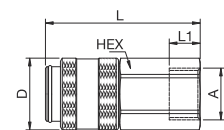

A	HEX	L	L1	D	
G3/4	39KLIW26MPN	41	99	20	46
G1	39KLIW33MPN	41	100	20	46

39SBIW Acoplador con válvula, rosca hembra

Latón niquelado, NBR

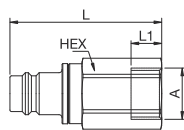

A	HEX	L	L1	
G3/4	39SBIW26MPN	41	96	19
G1	39SBIW33MPN	41	97	24

39KLTF Enchufe con válvula, conexión manguera

Latón niquelado, NBR

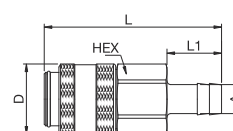

A	HEX	L	L1	D	
19	39KLTF19MPN	41	115	36	46
25	39KLTF25MPN	41	125	48	46

Serie 39 - Latón / Acero



Sin goteo

39SLAW Acoplador con válvula, rosca macho

Latón niquelado, NBR

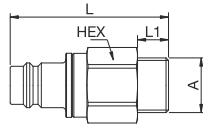

A		HEX	L	L1
G3/4	39SLAW26MPN	41	92	16
G1	39SLAW33MPN	41	95	19

39SLIW Acoplador con válvula, rosca hembra

Latón niquelado, NBR

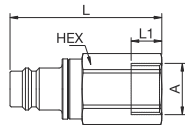

A		HEX	L	L1
G3/4	39SLIW26MPN	41	96	16
G1	39SLIW33MPN	41	97	24

39SLTF Acoplador con válvula, conexión manguera

Latón niquelado, NBR

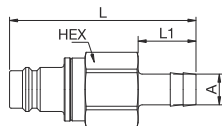

A		HEX	L	L1
19	39SLTF19MPN	41	114	36
25	39SLTF25MPN	41	124	48

Serie 70 - Latón / Acero

Diámetro nominal
4,3 - 20



Serie de acopladores en tamaños de 1/8" a 1" con perfil de enchufe conforme a la norma ISO 7241-1 serie B. Especialmente adecuados para su uso con medios líquidos. Sistema de acoplamiento con operación a dos manos, es decir, se requieren ambas manos para acoplar y desacoplar. La serie de acoplamientos se caracteriza por su alto caudal y una baja caída de presión.

- Disponible a petición:
- otras juntas para diferentes rangos de temperatura y fluidos

Serie 71 (50%)



Serie 72 (50%)



Serie 73 (50%)



Serie 74 (50%)



Serie 75 (50%)



Serie 76 (50%)



Perfil ISO 7241-1 B



Doble obturación

Presión de trabajo*:
see table

Material:

- Enchufe: Latón
- Acoplador: Latón
- Junta: NBR

Temperatura de trabajo:
-20°C hasta +100°C (NBR)

Caudal de agua:

- Serie 71: 6 l/min.
- Serie 72: 9 l/min.
- Serie 73: 17 l/min.
- Serie 74: 33 l/min.
- Serie 75: 79 l/min.
- Serie 76: 117 l/min.

caída de presión de 0,5 bar

* máxima presión estática de trabajo con un factor de diseño de 4 a 1.



Doble obturación



Doble obturación

70KBIW Enchufe con válvula, rosca hembra

Latón, NBR

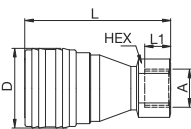

Di- men- sión	A	HEX	L	L1	D	Versión	Presión máxima de trabajo	
1/8"	G1/8	71KBIW10MPX	14	48,5	7	25	Latón	250
	G1/8	71KBIW10MPN	14	48,5	7	25	Latón niquelado	250
1/4"	G1/4	72KBIW13MPX	19	57,5	10	25	Latón	200
	G1/4	72KBIW13MPN	19	57,5	10	25	Latón niquelado	200
3/8"	G3/8	73KBIW17MPX	22	64	11,5	35	Latón	200
	G3/8	73KBIW17MPN	22	64	11,5	35	Latón niquelado	200
1/2"	G1/2	74KBIW21MPX	27	76	16	44,5	Latón	150
	G1/2	74KBIW21MPN	27	76	16	44,5	Latón niquelado	150
3/4"	G3/4	75KBIW26MPX	34	96	24	55	Latón	100
	G3/4	75KBIW26MPN	34	96	24	55	Latón niquelado	100
1"	G1	76KBIW33MPX	41	105,5	24	62	Latón	100
	G1	76KBIW33MPN	41	105,5	24	62	Latón niquelado	100

70SBIW Acoplador con válvula, rosca hembra

Latón, NBR

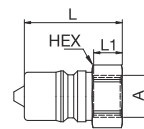

Di- men- sión	A	HEX	L	L1	Versión	Presión máxima de trabajo	
1/8"	G1/8	71SBIW10MPX	14	29,5	7	Latón	250
	G1/8	71SBIW10MPN	14	29,5	7	Latón niquelado	250
1/4"	G1/4	72SBIW13MPX	19	35	10	Latón	200
	G1/4	72SBIW13MPN	19	35	10	Latón niquelado	200
3/8"	G3/8	73SBIW17MPX	22	39	11,5	Latón	200
	G3/8	73SBIW17MPN	22	39	11,5	Latón niquelado	200
1/2"	G1/2	74SBIW21MPX	27	48	16	Latón	150
	G1/2	74SBIW21MPN	27	48	16	Latón niquelado	150
3/4"	G3/4	75SBIW26MPX	36	60	24	Latón	100
	G3/4	75SBIW26MPN	36	60	24	Latón niquelado	100
1"	G1	76SBIW33MPX	41	65	24	Latón	100
	G1	76SBIW33MPN	41	65	24	Latón niquelado	100

Serie 20 - Acero inoxidable

Diámetro nominal
2,7 = 6 mm²



Acoplamiento mini industrial con perfil de uso internacional. Uso frecuente en tecnología médica y en química/farmacia. Sistema de acoplamiento con operación de una sola mano. Alto caudal a pesar de sus pequeñas dimensiones. Amplia gama de aplicaciones con diferentes medios.

- Disponible a petición:
 - con conexiones finales adicionales
 - otras juntas para diferentes rangos de temperatura y fluidos



Perfil de Euro

KA Simple obturación

Presión de trabajo*:
hasta 35 bar

Material:

- Enchufe: AISI 303 / AISI 316 L
- Acoplador: AISI 303 / AISI 316 L
- Junta: FKM

Temperatura de trabajo:
-15°C hasta +200°C (FKM)

Caudal de aire:
165 l/min.
presión de entrada 6 bar, caída de presión 0,5 bar

Caudal de agua:
1,5 l/min.
caída de presión de 0,5 bar

KB Doble obturación

Presión de trabajo*:
hasta 35 bar

Material:

- Enchufe: AISI 303 / AISI 316 L
- Acoplador: AISI 303 / AISI 316 L
- Junta: FKM

Temperatura de trabajo:
-15°C hasta +200°C (FKM)

Caudal de aire:
130 l/min.
presión de entrada 6 bar, caída de presión 0,5 bar

Caudal de agua:
1,2 l/min.
caída de presión de 0,5 bar

* máxima presión estática de trabajo con un factor de diseño de 4 a 1.

Simple obturación

20KAA Enchufe con válvula, rosca macho

Acero inoxidable, FKM

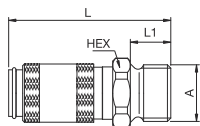

A	HEX	L	L1	D	Versión	
M5	20KAAM05RVX	9	26	5	10	AISI 303
	20KAAM05EVX	9	26	5	10	AISI 316L
G1/8	20KAAW10RVX	11	28	7	10	AISI 303
	20KAAW10EVX	11	28	7	10	AISI 316L

Simple obturación

20KATF Enchufe con válvula, conexión manguera

Acero inoxidable, FKM

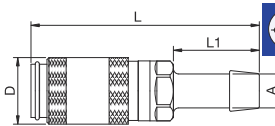

A	L	L1	D	Versión	
4	20KATF04RVX	35	13	10	AISI 303
	20KATF04EVX	35	13	10	AISI 316L
5	20KATF05RVX	35	13	10	AISI 303

20KAI Enchufe con válvula, rosca hembra

Acero inoxidable, FKM

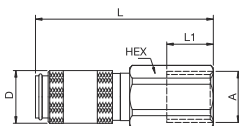

A	HEX	L	L1	D	Versión	
M5	20KAIM05RVX	9	25	5	10	AISI 303
	20KAIM05EVX	9	25	5	10	AISI 316L
G1/8	20KAIW10RVX	12	28	7	10	AISI 303
	20KAIW10EVX	12	28	7	10	AISI 316L

20KAKO Enchufe con válvula, con conexión de manguera de plástico

Acero inoxidable, FKM

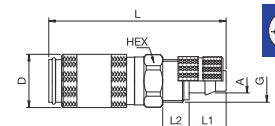

A	HEX	G	L	L1	L2	D	Versión	
3 x 4	20KAKO04RVX	9	M7x0,5	34	7	5	10	AISI 303
	20KAKO04EVX	9	M7x0,5	34	7	5	10	AISI 316L
3 x 5	20KAKO05RVX	9	M7x0,5	34	7	5	10	AISI 303
	20KAKO05EVX	9	M7x0,5	34	7	5	10	AISI 316L
4 x 6	20KAKO06RVX	9	M8x0,5	34	7	5	10	AISI 303
	20KAKO06EVX	9	M8x0,5	34	7	5	10	AISI 316L

Serie 20 - Acero inoxidable

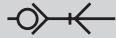

Simple obturación

20KAKS Enchufe con válvula, montaje en panel con conexión de manguera plástica

Acero inoxidable AISI 303, FKM

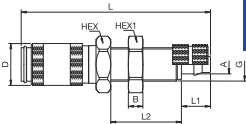

A	HEX	HEX1	B	G	L	L1	L2	D	
3 x 4	20KAKS04RVX	12	11	3	M7x0,5	45	7	17	10
3 x 5	20KAKS05RVX	12	11	3	M7x0,5	45	7	17	10
4 x 6	20KAKS06RVX	12	11	3	M8x0,5	45	7	17	10

20SFA Acoplador sin válvula, rosca macho

Acero inoxidable

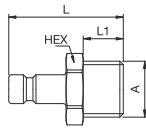

A	HEX	L	L1	Versión	
M5	20SFAM05RXX	7	18	5	AISI 303
	20SFAM05EXX	7	18	5	AISI 316L
	20SFAW10RXX	11	20	7	AISI 303
G1/8	20SFAW10EXX	11	20	7	AISI 316L

20SFI Acoplador sin válvula, rosca hembra

Acero inoxidable

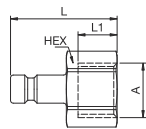

A	HEX	L	L1	Versión	
M5	20SFIM05RXX	7	17	5	AISI 303
	20SFIM05EXX	7	17	5	AISI 316L
	20SFIW10RXX	12	19	7	AISI 303
G1/8	20SFIW10EXX	12	19	7	AISI 316L

20SFTF Acoplador sin válvula, conexión manguera

Acero inoxidable

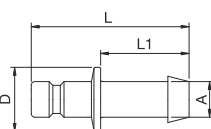

A	L	L1	D	Versión	
4	20SFTF04RXX	24	13	7	AISI 303
	20SFTF04EXX	24	13	7	AISI 316L
5	20SFTF05RXX	22	13	9	AISI 303

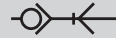

Simple obturación

20SFKO Acoplador sin válvula, con conexión de manguera de plástico

Acero inoxidable

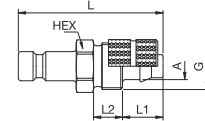

A	HEX	G	L	L1	L2	Versión	
3 x 4	20SFK004RXX	8	M7x0,5	25	7	5	AISI 303
	20SFK004EXX	8	M7x0,5	25	7	5	AISI 316L
3 x 5	20SFK005RXX	8	M7x0,5	25	7	5	AISI 303
	20SFK005EXX	8	M7x0,5	25	7	5	AISI 316L
4 x 6	20SFK006RXX	8	M8x0,5	25	7	5	AISI 303
	20SFK006EXX	8	M8x0,5	25	7	5	AISI 316L



Doble obturación

20KBA Enchufe con válvula, rosca macho

Acero inoxidable, FKM

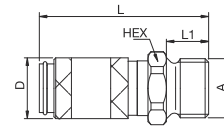

A	HEX	L	L1	D	Versión	
M5	20KBAM05RVX	9	26	5	10	AISI 303
	20KBAM05EVX	9201X20 19	9	26	5	10
G1/8	20KBAW10RVX	11	28	7	10	AISI 303
	20KBAW10EVX	9201X20 10	11	28	7	10

20KBI Enchufe con válvula, rosca hembra

Acero inoxidable, FKM

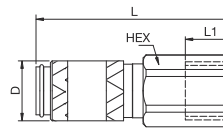

A	HEX	L	L1	D	Versión	
M5	20KBIM05RVX	9	25	5	10	AISI 303
	20KBIM05EVX	9214X20 19	9	25	5	10
G1/8	20KBIW10RVX	12	28	7	10	AISI 303
	20KBIW10EVX	9214X20 10	12	28	7	10

Serie 20 - Acero inoxidable

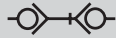

Doble obturación

20KBTf Enchufe con válvula, conexión manguera

Acero inoxidable, FKM

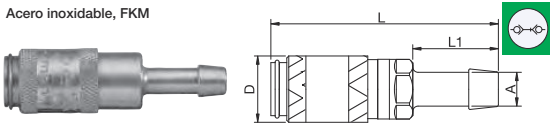

A		L	L1	D	Versión
4	20KBTf04RVX	35	13	10	AISI 303
	20KBTf04EVX	35	13	10	AISI 316L
5	20KBTf05RVX	35	13	10	AISI 303

20KBK0 Enchufe con válvula, con conexión de manguera de plástico

Acero inoxidable, FKM

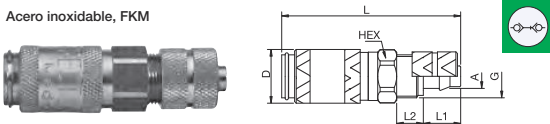

A		HEX	G	L	L1	L2	D	Versión
3 x 4	20KBK004RVX	9	M7x0,5	34	7	5	10	AISI 303
	20KBK004EVX	9	M7x0,5	34	7	5	10	AISI 316L
3 x 5	20KBK005RVX	9	M7x0,5	34	7	5	10	AISI 303
	20KBK005EVX	9	M7x0,5	34	7	5	10	AISI 316L
4 x 6	20KBK006RVX	9	M8x0,5	34	7	5	10	AISI 303
	20KBK006EVX	9	M8x0,5	34	7	5	10	AISI 316L

20KBKS Enchufe con válvula, montaje en panel con conexión de manguera plástica

Acero inoxidable AISI 303, FKM

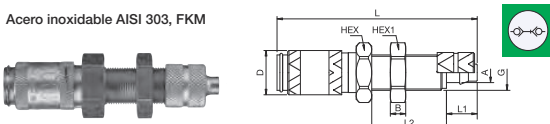

A		HEX	HEX1	B	G	L	L1	L2	D
3 x 4	20KBKS04RVX	12	11	3	M7x0,5	45	7	17	10
	20KBKS05RVX	12	11	3	M7x0,5	45	7	17	10
4 x 6	20KBKS06RVX	12	12	3,5	M8x0,5	45	7	17	10

20SBA Acoplador con válvula, rosca macho

Acero inoxidable, FKM

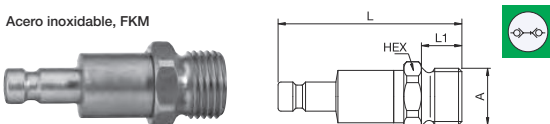

A		HEX	L	L1	Versión
M5	20SBAM05RVX	9	28	5	AISI 303
	20SBAM05EVX	9287X20 19	9	28	AISI 316L
G1/8	20SBAW10RVX	11	30	7	AISI 303
	20SBAW10EVX	9287X20 10	11	30	AISI 316L

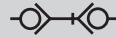

Doble obturación

20SBI Acoplador con válvula, rosca hembra

Acero inoxidable, FKM

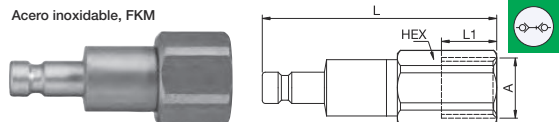

A		HEX	L	L1	Versión
M5	20SBIM05RVX	9	27	5	AISI 303
	20SBIM05EVX	9	27	5	AISI 316L
G1/8	20SBIW10RVX	12	30	7	AISI 303
	20SBIW10EVX	9286X20 10	12	30	AISI 316L

20SBTF Acoplador con válvula, conexión manguera

Acero inoxidable, FKM

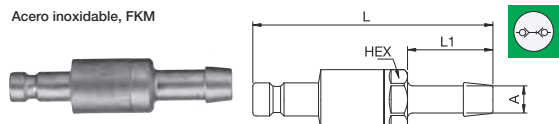

A		HEX	L	L1	Versión
4	20SBTF04RVX	8	37	13	AISI 303
	20SBTF04EVX	8	37	13	AISI 316L
5	20SBTF05RVX	8	37	13	AISI 303

20SBK0 Acoplador con válvula, con conexión de manguera de plástico

Acero inoxidable, FKM

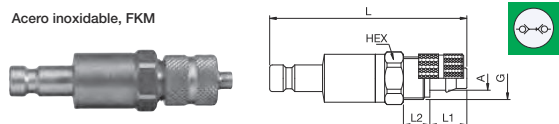

A		HEX	G	L	L1	L2	Versión
3 x 4	20SBK004RVX	9	M7x0,5	36	7	5	AISI 303
	20SBK004EVX	9	M7x0,5	36	7	5	AISI 316L
3 x 5	20SBK005RVX	9	M7x0,5	36	7	5	AISI 303
	20SBK005EVX	9	M7x0,5	36	7	5	AISI 316L
4 x 6	20SBK006RVX	9	M8x0,5	36	7	5	AISI 303
	20SBK006EVX	9	M8x0,5	36	7	5	AISI 316L

20SBKS Acoplador con válvula, montaje en panel con conexión de manguera plástica

Acero inoxidable AISI 303, FKM

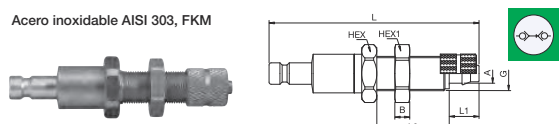

A		HEX	HEX1	B	G	L	L1	L2
3 x 4	20SBKS04RVX	12	11	3	M7x0,5	47	7	17
3 x 5	20SBKS05RVX	12	11	3	M7x0,5	47	7	17
4 x 6	20SBKS06RVX	12	12	3,5	M8x0,5	47	7	17

Serie 303 - Acero inoxidable

Diámetro nominal
3 = 7 mm²



Acoplamiento mini industrial con perfil de enchufe según ISO 6150 C. Perfil popular en la tecnología analítica y médica. Rendimiento de caudal superior a la media para medios líquidos y gaseosos.

- Disponible a petición:
 - con conexiones finales adicionales
 - otras juntas para diferentes rangos de temperatura y fluidos

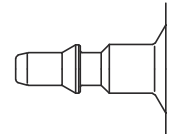

Perfil ISO 6150 C



Presión de trabajo*:
hasta 35 bar

Material:

- Enchufe: AISI 316 L
- Acoplador: AISI 316 L
- Junta: FKM

Temperatura de trabajo:
-15°C hasta +200°C (FKM)

Caudal de aire:
160 l/min.
presión de entrada 6 bar, caída de presión 0,5 bar

Caudal de agua:
2,2 l/min.
caída de presión de 0,5 bar

* máxima presión estática de trabajo con un factor de diseño de 4 a 1.

 Doble obturación

 Doble obturación

303BAW Enchufe con válvula, rosca macho

Acero inoxidable AISI 316 L, FKM

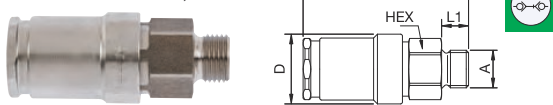

A	HEX	L	L1	D
G1/8	303BAW10EVX	14	43	7 18
G1/4	303BAW13EVX	17	45	9 18

303BKO Enchufe con válvula, con conexión de manguera de plástico

Acero inoxidable AISI 316 L, FKM

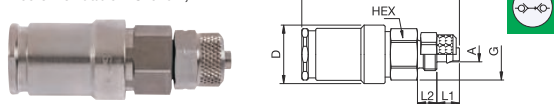

A	HEX	G	L	L1	L2	D
4 x 6	303BKO06EVX	14	M10x1	49	7 6	18
6 x 8	303BKO08EVX	14	M12x1	49	7 6	18

303BIW Enchufe con válvula, rosca hembra

Acero inoxidable AISI 316 L, FKM

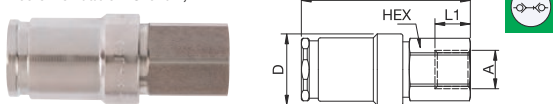

A	HEX	L	L1	D
G1/8	303BIW10EVX	14	43	9 18
G1/4	303BIW13EVX	17	45	9 18

303SBW Acoplador con válvula, rosca macho

Acero inoxidable AISI 316 L, FKM

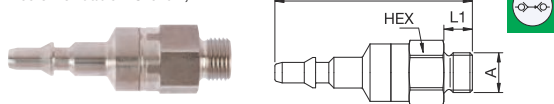

A	HEX	L	L1
G1/8	303SBW10EVX	14	48,5 7
G1/4	303SBW13EVX	17	50,5 9

Serie 303 - Acero inoxidable

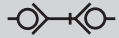

Doble obturación

303BIW Acoplador con válvula, rosca hembra

Acero inoxidable AISI 316 L, FKM

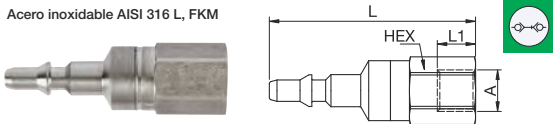

A		HEX	L	L1
G1/8	303BIW10EVX	14	48,5	9
G1/4	303BIW13EVX	17	50,5	9

303BKO Acoplador con válvula, con conexión de manguera de plástico

Acero inoxidable AISI 316 L, FKM

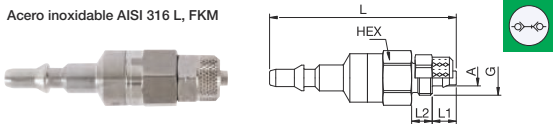

A		HEX	G	L	L1	L2
4 x 6	303BKO06EVX	14	M10x1	54,5	7	6
6 x 8	303BKO08EVX	14	M12x1	54,5	7	6

Serie 21 - Acero inoxidable

Diámetro nominal
5 = 20 mm²



Acoplamiento mini industrial con el perfil más popular del mundo en este diámetro nominal. Rendimiento de caudal superior a la media para medios líquidos y gaseosos. Sistema de acoplamiento con operación de una sola mano. Pequeñas dimensiones y gran ancho de banda en materiales y variantes de válvulas.

- Disponible a petición:
 - con conexiones finales adicionales
 - otras juntas para diferentes rangos de temperatura y fluidos

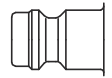

Perfil de Euro

Protecciones contra el polvo (P. 357)
para acoplar la pieza-No. SK16S

KA Simple obturación

Presión de trabajo*:
hasta 35 bar

Material:

- Enchufe: AISI 303 / AISI 316 L
- Acoplador: AISI 303 / AISI 316 L
- Junta: FKM

Temperatura de trabajo:
-15°C hasta +200°C (FKM)

Caudal de aire:

550 l/min.
presión de entrada 6 bar, caída de presión 0,5 bar

Caudal de agua:

7 l/min.
caída de presión de 0,5 bar

KB Doble obturación

Presión de trabajo*:
hasta 35 bar

Material:

- Enchufe: AISI 303 / AISI 316 L
- Acoplador: AISI 303 / AISI 316 L
- Junta: FKM

Temperatura de trabajo:
-15°C hasta +200°C (FKM)

Caudal de aire:

310 l/min.
presión de entrada 6 bar, caída de presión 0,5 bar

Caudal de agua:

2,7 l/min.
caída de presión de 0,5 bar

* máxima presión estática de trabajo con un factor de diseño de 4 a 1.

Simple obturación

Simple obturación

21KAAW Enchufe con válvula, rosca macho

Acero inoxidable, FKM

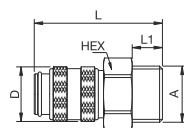

A		HEX	L	L1	D	Versión
G1/8	21KAAW10RVX	14	36	7	16	AISI 303
	21KAAW10EVX	14	36	7	16	AISI 316L
G1/4	21KAAW13RVX	17	38	9	16	AISI 303
	21KAAW13EVX	17	38	9	16	AISI 316L
G3/8	21KAAW17RVX	19	38	9	16	AISI 303
	21KAAW17EVX	19	38	9	16	AISI 316L

21KAIW Enchufe con válvula, rosca hembra

Acero inoxidable, FKM

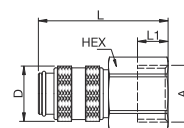

A		HEX	L	L1	D	Versión
G1/8	21KAIW10RVX	14	36	9	16	AISI 303
	21KAIW10EVX	14	36	9	16	AISI 316L
G1/4	21KAIW13RVX	17	38	9	16	AISI 303
	21KAIW13EVX	17	38	9	16	AISI 316L
G3/8	21KAIW17RVX	19	38	9	16	AISI 303
	21KAIW17EVX	19	38	9	16	AISI 316L

Serie 21 - Acero inoxidable



Simple obturación

21KATF Enchufe con válvula, conexión manguera

Acero inoxidable, FKM

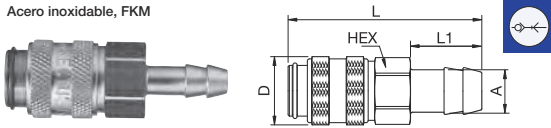

A	HEX	L	L1	D	Versión	
6	21KATF06RVX	14	46	17	16	AISI 303
	21KATF06EVX	14	46	17	16	AISI 316L
8	21KATF08RVX	14	46	17	16	AISI 303
	21KATF08EVX	14	46	17	16	AISI 316L
9	21KATF09RVX	14	46	17	16	AISI 303
	21KATF09EVX	14	46	17	16	AISI 316L
10	21KATF10RVX	14	46	17	16	AISI 303
	21KATF10EVX	14	46	17	16	AISI 316L

21KAKO Enchufe con válvula, con conexión de manguera de plástico

Acero inoxidable, FKM

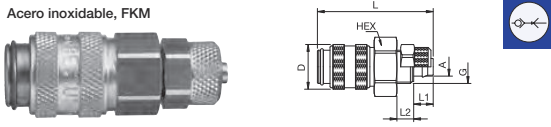

A	HEX	G	L	L1	L2	D	Versión	
4 x 6	21KAKO06RVX	14	M10x1	42	7	6	16	AISI 303
	21KAKO06EVX	14	M10x1	42	7	6	16	AISI 316L
6 x 8	21KAKO08RVX	14	M12x1	42	7	6	16	AISI 303
	21KAKO08EVX	14	M12x1	42	7	6	16	AISI 316L

21SAW Acoplador sin válvula, rosca macho

Acero inoxidable

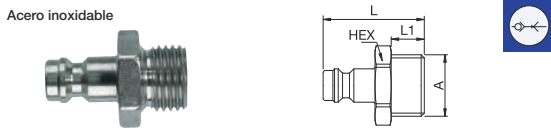

A	HEX	L	L1	Versión	
G1/8	21SAW10RXX	14	25	7	AISI 303
	21SAW10EXX	9087X21 10	14	25	7
G1/4	21SAW13RXX	17	28	9	AISI 303
	21SAW13EXX	9087X21 13	17	28	9
G3/8	21SAW17RXX	19	28	9	AISI 303



Simple obturación

21SFIW Acoplador sin válvula, rosca hembra

Acero inoxidable

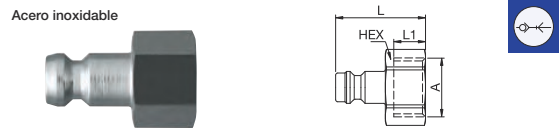

A	HEX	L	L1	Versión	
G1/8	21SFIW10RXX	14	25	8	AISI 303
	21SFIW10EXX	9086X21 10	14	25	8
G1/4	21SFIW13RXX	17	25	9	AISI 303
	21SFIW13EXX	9086X21 13	17	25	9
G3/8	21SFIW17RXX	19	26	9	AISI 303

21SFTF Acoplador sin válvula, conexión manguera

Acero inoxidable

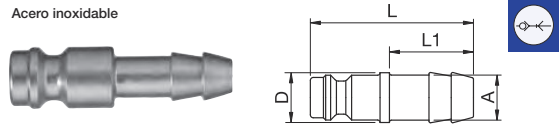

A	L	L1	D	Versión	
6	21SFTF06RXX	32	17	9	AISI 303
	21SFTF06EXX	32	17	9	AISI 316L
8	21SFTF08RXX	32	17	9	AISI 303
	21SFTF08EXX	32	17	9	AISI 316L
9	21SFTF09RXX	33	17	10	AISI 303
	21SFTF09EXX	33	17	10	AISI 316L
10	21SFTF10RXX	33	17	12	AISI 303
	21SFTF10EXX	33	17	12	AISI 316L

21SFKO Acoplador sin válvula, conexión manguera de plástico

Acero inoxidable

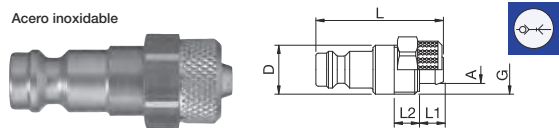

A	HEX	HEX1	G	L	L1	L2	D	Versión	
4 x 6	21SFKO06RXX	12	12	M10x1	32	7	6	10	AISI 303
	21SFKO06EXX	12	12	M10x1	32	7	6	10	AISI 316L
6 x 8	21SFKO08RXX	14	14	M12x1	32	7	6	12	AISI 303
	21SFKO08EXX	14	14	M12x1	32	7	6	12	AISI 316L

Serie 21 - Acero inoxidable

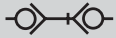

Doble obturación

21KBAW Enchufe con válvula, rosca macho

Acero inoxidable, FKM

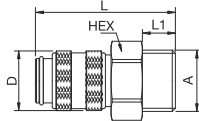

A			HEX	L	L1	D	Versión
G1/8	21KBAW10RVX		14	36	7	16	AISI 303
	21KBAW10EVX	9201X21 10	14	36	7	16	AISI 316L
G1/4	21KBAW13RVX		17	38	9	16	AISI 303
	21KBAW13EVX	9201X21 13	17	38	9	16	AISI 316L
G3/8	21KBAW17RVX		19	38	9	16	AISI 303
	21KBAW17EVX		19	38	9	16	AISI 316L

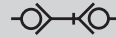

Doble obturación

21KBKO Enchufe con válvula, con conexión de manguera de plástico

Acero inoxidable, FKM

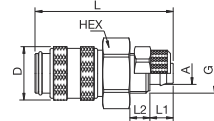

A			HEX	G	L	L1	L2	D	Versión
4 x 6	21KBKO06RVX		14	M10x1	42	7	6	16	AISI 303
	21KBKO06EVX		14	M10x1	42	7	6	16	AISI 316L
6 x 8	21KBKO08RVX		14	M12x1	42	7	6	16	AISI 303
	21KBKO08EVX		14	M12x1	42	7	6	16	AISI 316L

21KBIW Enchufe con válvula, rosca hembra

Acero inoxidable, FKM

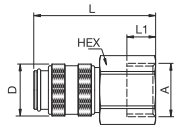

A			HEX	L	L1	D	Versión
G1/8	21KBIW10RVX		14	36	9	16	AISI 303
	21KBIW10EVX	9214X21 10	14	36	9	16	AISI 316L
G1/4	21KBIW13RVX		17	38	7	16	AISI 303
	21KBIW13EVX	9214X21 13	17	38	7	16	AISI 316L
G3/8	21KBIW17RVX		19	38	9	16	AISI 303
	21KBIW17EVX		19	38	9	16	AISI 316L

21SBAW Acoplador con válvula, rosca macho

Acero inoxidable, FKM

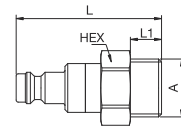

A			HEX	L	L1	Versión
G1/8	21SBAW10RVX		14	40	7	AISI 303
	21SBAW10EVX	9287X21 10	14	40	7	AISI 316L
G1/4	21SBAW13RVX		17	42	9	AISI 303
	21SBAW13EVX	9287X21 13	17	42	9	AISI 316L
G3/8	21SBAW17RVX		19	42	9	AISI 303
	21SBAW17EVX		19	42	9	AISI 316L

21KBTf Enchufe con válvula, conexión manguera

Acero inoxidable, FKM

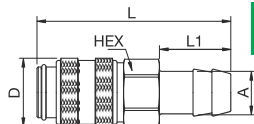

A			HEX	L	L1	D	Versión
6	21KBTf06RVX		14	46	17	16	AISI 303
	21KBTf06EVX		14	46	17	16	AISI 316L
8	21KBTf08RVX		14	46	17	16	AISI 303
	21KBTf08EVX		14	46	17	16	AISI 316L
9	21KBTf09RVX		14	46	17	16	AISI 303
	21KBTf09EVX		14	46	17	16	AISI 316L
10	21KBTf10RVX		14	46	17	16	AISI 303
	21KBTf10EVX		14	46	17	16	AISI 316L

21SBIW Acoplador con válvula, rosca hembra

Acero inoxidable, FKM

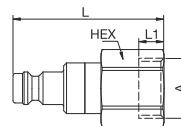

A			HEX	L	L1	Versión
G1/8	21SBIW10RVX		14	40	9	AISI 303
	21SBIW10EVX	9286X21 10	14	40	9	AISI 316L
G1/4	21SBIW13RVX		17	42	7	AISI 303
	21SBIW13EVX	9286X21 13	17	42	7	AISI 316L
G3/8	21SBIW17RVX		19	42	9	AISI 303
	21SBIW17EVX		19	42	9	AISI 316L

Serie 21 - Acero inoxidable

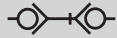

Doble obturación

21SBTF Acoplador con válvula, conexión manguera

Acero inoxidable, FKM

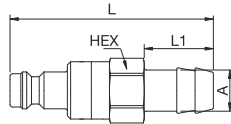

A		HEX	L	L1	Versión
6	21SBTF06RVX	14	50	17	AISI 303
	21SBTF06EVX	14	50	17	AISI 316L
8	21SBTF08RVX	14	50	17	AISI 303
	21SBTF08EVX	14	50	17	AISI 316L
9	21SBTF09RVX	14	50	17	AISI 303
	21SBTF09EVX	14	50	17	AISI 316L
10	21SBTF10RVX	14	50	17	AISI 303
	21SBTF10EVX	14	50	17	AISI 316L

21SBK0 Acoplador con válvula, con conexión de manguera de plástico

Acero inoxidable, FKM

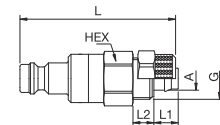

A		HEX	G	L	L1	L2	Versión
4 x 6	21SBK006RVX	14	M10x1	46	7	6	AISI 303
	21SBK006EVX	14	M10x1	46	7	6	AISI 316L
6 x 8	21SBK008RVX	14	M12x1	46	7	6	AISI 303
	21SBK008EVX	14	M12x1	46	7	6	AISI 316L

Serie 25 - Acero inoxidable

Diámetro nominal
7,4 = 42 mm²



Acoplamiento industrial universal con perfil europeo estándar para uso con medios gaseosos, líquidos y agresivos. Sistema de acoplamiento con manejo con una sola mano. Válvula de alto caudal para un flujo óptimo y una baja caída de presión. La serie destaca por su diseño robusto y su larga vida útil incluso con el uso más duro. El diseño del cuello minimiza los daños en el cuerpo de la válvula.

- Disponible a petición:

- con conexiones finales adicionales
- otras juntas para diferentes rangos de temperatura y fluidos

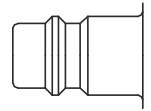

Perfil de Euro

Protecciones contra el polvo (P. 357)
para acoplar la pieza-No. SK23S
para enchufe la pieza-No. SK12S

KA Simple obturación

Presión de trabajo*:
hasta 35 bar

Material:

- Enchufe: AISI 303 / AISI 316 L
- Acoplador: AISI 303 / AISI 316 L
- Junta: FKM

Temperatura de trabajo:
-15°C hasta +200°C (FKM)

Caudal de aire:

1.800 l/min.
presión de entrada 6 bar, caída de presión 0,5 bar

Caudal de agua:

28 l/min.
caída de presión de 0,5 bar

KB Doble obturación

Presión de trabajo*:
hasta 35 bar

Material:

- Enchufe: AISI 303 / AISI 316 L
- Acoplador: AISI 303 / AISI 316 L
- Junta: FKM

Temperatura de trabajo:
-15°C hasta +200°C (FKM)

Caudal de aire:

710 l/min.
presión de entrada 6 bar, caída de presión 0,5 bar

Caudal de agua:

7,1 l/min.
caída de presión de 0,5 bar

* máxima presión estática de trabajo con un factor de diseño de 4 a 1.

Simple obturación

Simple obturación

25KAAW Enchufe con válvula, rosca macho

Acero inoxidable, FKM

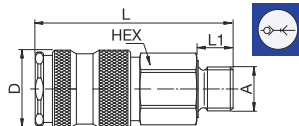

A	HEX	L	L1	D	Versión
G1/4	25KAAW13RVX	19	60	10,5	AISI 303
	25KAAW13EVX	19	60	10,5	AISI 316L
G3/8	25KAAW17RVX	19	58	9	AISI 303
	25KAAW17EVX	19	58	9	AISI 316L
G1/2	25KAAW21RVX	24	61	12	AISI 303
	25KAAW21EVX	24	61	12	AISI 316L

25KAIW Enchufe con válvula, rosca hembra

Acero inoxidable, FKM

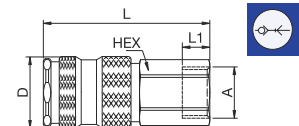

A	HEX	L	L1	D	Versión
G1/4	25KAIW13RVX	19	56	10	AISI 303
	25KAIW13EVX	19	56	10	AISI 316L
G3/8	25KAIW17RVX	19	55	9	AISI 303
	25KAIW17EVX	19	55	9	AISI 316L
G1/2	25KAIW21RVX	24	58	12	AISI 303
	25KAIW21EVX	24	58	12	AISI 316L

Serie 25 - Acero inoxidable



Simple obturación

25KATF Enchufe con válvula, conexión manguera

Acero inoxidable, FKM

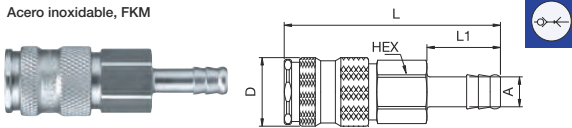

A	HEX	L	L1	D	Versión
6	25KATF06RVX	19	74	25	AISI 303
	25KATF06EVX	19	74	25	AISI 316L
8	25KATF08RVX	19	74	25	AISI 303
	25KATF08EVX	19	74	25	AISI 316L
9	25KATF09RVX	19	74	25	AISI 303
	25KATF09EVX	19	74	25	AISI 316L
10	25KATF10RVX	19	74	25	AISI 303
	25KATF10EVX	19	74	25	AISI 316L
13	25KATF13RVX	19	74	25	AISI 303
	25KATF13EVX	19	74	25	AISI 316L



Simple obturación

25SFTF Acoplador sin válvula, conexión manguera

Acero inoxidable

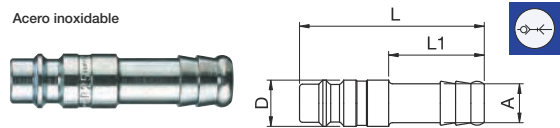

A	L	L1	D	Versión
6	25SFTF06RXX	48	25	AISI 303
	25SFTF06EXX	48	25	AISI 316L
8	25SFTF08RXX	48	25	AISI 303
	25SFTF08EXX	48	25	AISI 316L
9	25SFTF09RXX	48	25	AISI 303
	25SFTF09EXX	48	25	AISI 316L
10	25SFTF10RXX	48	25	AISI 303
	25SFTF10EXX	48	25	AISI 316L
13	25SFTF13RXX	48	25	AISI 303
	25SFTF13EXX	48	25	AISI 316L

25SFAW Acoplador sin válvula, rosca macho

Acero inoxidable

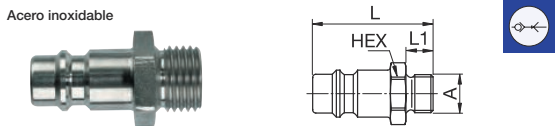

A	HEX	L	L1	Versión
G1/8	25SFAW10RXX	14	31	AISI 303
	25SFAW13RXX	17	33	AISI 303
G1/4	25SFAW13EXX	17	33	AISI 316L
	25SFAW17RXX	19	33	AISI 303
G3/8	25SFAW17EXX	19	33	AISI 316L
	25SFAW21RXX	24	38	AISI 303
G1/2	25SFAW21EXX	24	38	AISI 316L
		9087X25 21		



Doble obturación

25KBAW Enchufe con válvula, rosca macho

Acero inoxidable, FKM

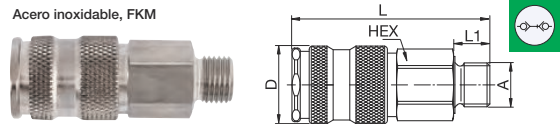

A	HEX	L	L1	D	Versión
G1/4	25KBAW13RVX	19	60	10,5	AISI 303
	25KBAW13EVX	9201X25 13	19	60	AISI 316L
G3/8	25KBAW17RVX	19	58	9	AISI 303
	25KBAW17EVX	9201X25 17	19	58	AISI 316L
G1/2	25KBAW21RVX	24	61	12	AISI 303
	25KBAW21EVX	9201X25 21	24	61	AISI 316L

25SFIW Acoplador sin válvula, rosca hembra

Acero inoxidable

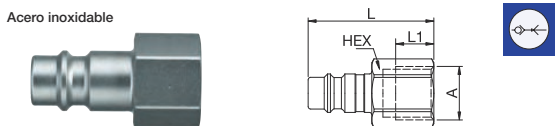

A	HEX	L	L1	Versión
G1/8	25SFIW10RXX	14	30	AISI 303
	25SFIW13RXX	17	33	AISI 303
G1/4	25SFIW13EXX	17	33	AISI 316L
	25SFIW17RXX	19	33	AISI 303
G3/8	25SFIW17EXX	19	33	AISI 316L
	25SFIW21RXX	24	35	AISI 303
G1/2	25SFIW21EXX	24	35	AISI 316L
		9086X25 13		
				9086X25 17

25KBIW Enchufe con válvula, rosca hembra

Acero inoxidable, FKM

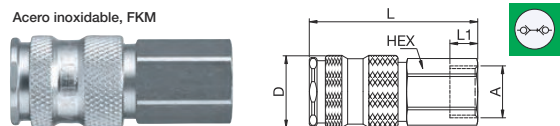

A	HEX	L	L1	D	Versión
G1/4	25KBIW13RVX	19	56	10	AISI 303
	25KBIW13EVX	9214X25 13	19	56	AISI 316L
G3/8	25KBIW17RVX	19	55	9	AISI 303
	25KBIW17EVX	9214X25 17	19	55	AISI 316L
G1/2	25KBIW21RVX	24	58	12	AISI 303
	25KBIW21EVX	9214X25 21	24	58	AISI 316L

Serie 25 - Acero inoxidable

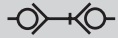

Doble obturación

25KBTF Enchufe con válvula, conexión manguera

Acero inoxidable, FKM

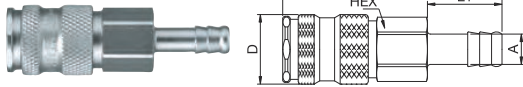

A		HEX	L	L1	D	Versión
6	25KBTFO6RVX	19	74	25	23	AISI 303
	25KBTFO6EVX	19	74	25	23	AISI 316L
8	25KBTFO8RVX	19	74	25	23	AISI 303
	25KBTFO8EVX	19	74	25	23	AISI 316L
9	25KBTFO9RVX	19	74	25	23	AISI 303
	25KBTFO9EVX	19	74	25	23	AISI 316L
10	25KBTFO10RVX	19	74	25	23	AISI 303
	25KBTFO10EVX	19	74	25	23	AISI 316L
13	25KBTFO13RVX	19	74	25	23	AISI 303
	25KBTFO13EVX	19	74	25	23	AISI 316L



Doble obturación

25SBTF Acoplador con válvula, conexión manguera

Acero inoxidable, FKM

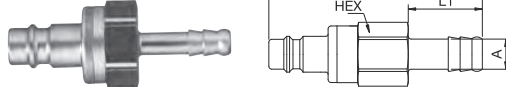

A		HEX	L	L1	Versión
6	25SBTF06RVX	19	72	25	AISI 303
	25SBTF06EVX	19	72	25	AISI 316L
8	25SBTF08RVX	19	72	25	AISI 303
	25SBTF08EVX	19	72	25	AISI 316L
9	25SBTF09RVX	19	72	25	AISI 303
	25SBTF09EVX	19	72	25	AISI 316L
10	25SBTF10RVX	19	72	25	AISI 303
	25SBTF10EVX	19	72	25	AISI 316L
13	25SBTF13RVX	19	72	25	AISI 303
	25SBTF13EVX	19	72	25	AISI 316L

25SBAW Acoplador con válvula, rosca macho

Acero inoxidable, FKM

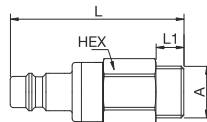

A		HEX	L	L1	Versión
G1/4	25SBAW13RVX	19	58	10,5	AISI 303
	25SBAW13EVX	9287X25 13	19	58	10,5
G3/8	25SBAW17RVX	19	56	9	AISI 303
	25SBAW17EVX	9287X25 17	19	56	9
G1/2	25SBAW21RVX	24	59	12	AISI 303
	25SBAW21EVX	9287X25 21	24	59	12

25SBIW Acoplador con válvula, rosca hembra

Acero inoxidable, FKM

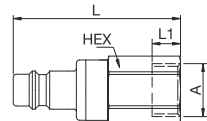

A		HEX	L	L1	Versión
G1/4	25SBIW13RVX	19	54	10	AISI 303
	25SBIW13EVX	9286X25 13	19	54	10
G3/8	25SBIW17RVX	19	53	9	AISI 303
	25SBIW17EVX	9286X25 17	19	53	9
G1/2	25SBIW21RVX	24	56	12	AISI 303
	25SBIW21EVX	9286X25 21	24	56	12

Serie 27 - Acero inoxidable

Diámetro nominal
10 = 80 mm²



Acoplador industrial universal de 1/2" con perfil europeo estándar para su uso con grandes consumidores de neumáticos. Sistema de acoplamiento con operación de una sola mano. Válvula de alto caudal para un flujo óptimo y una baja caída de presión. La serie se distingue por su diseño robusto, un flujo extremadamente alto y una larga vida útil incluso con el uso más duro. El diseño del cuello minimiza los daños en el cuerpo de la válvula.

- Disponible a petición:
 - con conexiones finales adicionales
 - otras juntas para diferentes rangos de temperatura y fluidos

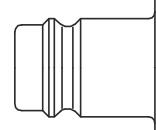

Perfil de Euro

Protecciones contra el polvo (P.357)
para acoplar la pieza-No. SK27



Simple obturación

Presión de trabajo*:
hasta 35 bar

Material:

- Enchufe: AISI 303 / AISI 316 L
- Acoplador: AISI 303 / AISI 316 L
- Junta: FKM

Temperatura de trabajo:
-15°C hasta +200°C (FKM)

Caudal de aire:

2.400 l/min.
presión de entrada 6 bar, caída de presión 0,5 bar

Caudal de agua:

31 l/min.
caída de presión de 0,5 bar



Doble obturación

Presión de trabajo*:
hasta 35 bar

Material:

- Enchufe: AISI 303 / AISI 316 L
- Acoplador: AISI 303 / AISI 316 L
- Junta: FKM

Temperatura de trabajo:
-15°C hasta +200°C (FKM)

Caudal de aire:

950 l/min.
presión de entrada 6 bar, caída de presión 0,5 bar

Caudal de agua:

14 l/min.
caída de presión de 0,5 bar

* máxima presión estática de trabajo con un factor de diseño de 4 a 1.



Simple obturación



Simple obturación

27KAAW Enchufe con válvula, rosca macho

Acero inoxidable, FKM

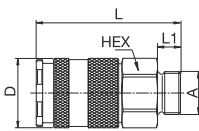

A	HEX	L	L1	D	Versión	
G3/8	27KAAW17RVX	24	58	9	27	AISI 303
	27KAAW17EVX	24	58	9	27	AISI 316L
G1/2	27KAAW21RVX	24	60	12	27	AISI 303
	27KAAW21EVX	24	60	12	27	AISI 316L
G3/4	27KAAW26RVX	32	61	16	27	AISI 303
	27KAAW26EVX	32	61	16	27	AISI 316L

27KAIW Enchufe con válvula, rosca hembra

Acero inoxidable, FKM

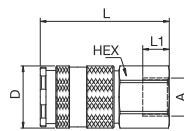

A	HEX	L	L1	D	Versión	
G3/8	27KAIW17RVX	24	56	11	27	AISI 303
	27KAIW17EVX	24	56	11	27	AISI 316L
G1/2	27KAIW21RVX	24	56	12	27	AISI 303
	27KAIW21EVX	24	56	12	27	AISI 316L
G3/4	27KAIW26RVX	32	60	16	27	AISI 303
	27KAIW26EVX	32	60	16	27	AISI 316L

Serie 27 - Acero inoxidable



Simple obturación

27KATF Enchufe con válvula, conexión manguera

Acero inoxidable, FKM

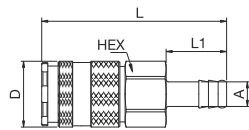

A		HEX	L	L1	D	Versión
9	27KATF09RVX	24	76	25	27	AISI 303
	27KATF09EVX	24	76	25	27	AISI 316L
13	27KATF13RVX	24	76	25	27	AISI 303
	27KATF13EVX	24	76	25	27	AISI 316L



Simple obturación

27SFTF Acoplador sin válvula, conexión manguera

Acero inoxidable

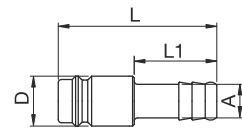

A		L	L1	D	Versión
9	27SFTF09RXX	48	25	15	AISI 303
	27SFTF09EXX	48	25	15	AISI 316L
13	27SFTF13RXX	48	25	15	AISI 303
	27SFTF13EXX	48	25	15	AISI 316L

27SAW Acoplador sin válvula, rosca macho

Acero inoxidable

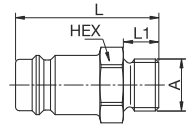

A		HEX	L	L1	Versión
G1/4	27SAW13RXX	17	36,5	9	AISI 303
	27SAW13EXX	17	36,5	9	AISI 316L
G3/8	27SAW17RXX	19	36,5	9	AISI 303
	27SAW17EXX	19	36,5	9	AISI 316L
G1/2	27SAW21RXX	24	40	12	AISI 303
	27SAW21EXX	9087X27 21	24	40	AISI 316L
G3/4	27SAW26RXX	32	45	16	AISI 303
	27SAW26EXX	9087X27 27	32	45	AISI 316L



Doble obturación

27KBAW Enchufe con válvula, rosca macho

Acero inoxidable, FKM

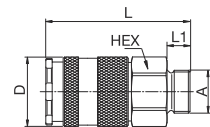

A		HEX	L	L1	D	Versión
G3/8	27KBAW17RVX	24	58	9	27	AISI 303
	27KBAW17EVX	9201X27 17	24	58	9	AISI 316L
G1/2	27KBAW21RVX	24	60	12	27	AISI 303
	27KBAW21EVX	9201X27 21	24	60	12	AISI 316L
G3/4	27KBAW26RVX	32	61	16	27	AISI 303
	27KBAW26EVX	9201X27 27	32	61	16	AISI 316L

27SFIW Acoplador sin válvula, rosca hembra

Acero inoxidable

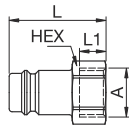

A		HEX	L	L1	Versión
G3/8	27SFIW17RXX	19	33	9	AISI 303
	27SFIW17EXX	9086X27 17	19	33	AISI 316L
G1/2	27SFIW21RXX	24	37	12	AISI 303
	27SFIW21EXX	24	37	12	AISI 316L
G3/4	27SFIW26RXX	32	42	16	AISI 303
	27SFIW26EXX	32	42	16	AISI 316L

27KBIW Enchufe con válvula, rosca hembra

Acero inoxidable, FKM

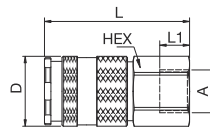

A		HEX	L	L1	D	Versión
G3/8	27KBIW17RVX	24	56	11	27	AISI 303
	27KBIW17EVX	9214X27 17	24	56	11	AISI 316L
G1/2	27KBIW21RVX	24	56	12	27	AISI 303
	27KBIW21EVX	9214X27 21	24	56	12	AISI 316L
G3/4	27KBIW26RVX	32	56	16	27	AISI 303
	27KBIW26EVX	9214X27 27	32	56	16	AISI 316L

Serie 27 - Acero inoxidable

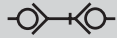

Doble obturación

27KBTF Enchufe con válvula, conexión manguera

Acero inoxidable, FKM

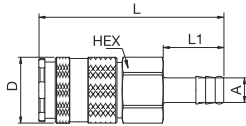
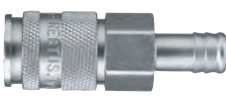

A		HEX	L	L1	D	Versión
9	27KBTF09RVX	24	76	25	27	AISI 303
	27KBTF09EVX	24	76	25	27	AISI 316L
13	27KBTF13RVX	24	76	25	27	AISI 303
	27KBTF13EVX	24	76	25	27	AISI 316L

27SBAW Acoplador con válvula, rosca macho

Acero inoxidable, FKM

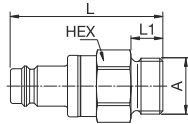

A		HEX	L	L1	Versión
G3/8	27SBAW17RVX	24	56	9	AISI 303
	27SBAW17EVX	9287X27 17	24	56	9
G1/2	27SBAW21RVX	24	58	12	AISI 303
	27SBAW21EVX	9287X27 21	24	58	12
G3/4	27SBAW26RVX	32	58	16	AISI 303
	27SBAW26EVX	9287X27 27	32	58	16

27SBIW Acoplador con válvula, rosca hembra

Acero inoxidable, FKM

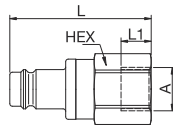

A		HEX	L	L1	Versión
G3/8	27SBIW17RVX	24	55	10	AISI 303
	27SBIW17EVX	9286X27 17	24	55	10
G1/2	27SBIW21RVX	24	55	12	AISI 303
	27SBIW21EVX	9286X27 21	24	55	12
G3/4	27SBIW26RVX	32	58	16	AISI 303
	27SBIW26EVX		32	58	16

27SBTF Acoplador con válvula, conexión manguera

Acero inoxidable, FKM

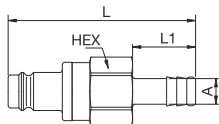

A		HEX	L	L1	Versión
9	27SBTF09RVX	24	75	25	AISI 303
	27SBTF09EVX	24	75	25	AISI 316L
13	27SBTF13RVX	24	75	25	AISI 303
	27SBTF13EVX	24	75	25	AISI 316L

Serie 70 - Acero inoxidable

Diámetro nominal
4,3 - 20



Serie de acopladores en tamaños de 1/8" a 1" con perfil de enchufe conforme a la norma ISO 7241-1 serie B. Especialmente adecuados para su uso con medios líquidos. Sistema de acoplamiento con operación a dos manos, es decir, se requieren ambas manos para acoplar y desacoplar. La serie de acoplamientos se caracteriza por su alto caudal y una baja caída de presión.

- Disponible a petición:
 - otras juntas para diferentes rangos de temperatura y fluidos

Serie 71 (50%) 

Serie 72 (50%) 

Serie 73 (50%) 

Serie 74 (50%) 

Serie 75 (50%) 

Serie 76 (50%) 

Perfil ISO 7241-1 B



Doble obturación

Presión de trabajo*:
ver tabla

Material:

- Enchufe: AISI 303 / AISI 316 L
- Acoplador: AISI 303 / AISI 316 L
- Junta: FKM

Temperatura de trabajo:
-15°C hasta +200°C (FKM)

Caudal de agua:

- Serie 71: 6 l/min.
 - Serie 72: 9 l/min.
 - Serie 73: 17 l/min.
 - Serie 74: 33 l/min.
 - Serie 75: 79 l/min.
 - Serie 76: 117 l/min.
- caída de presión de 0,5 bar

* máxima presión estática de trabajo con un factor de diseño de 4 a 1.

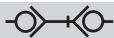

Doble obturación



Doble obturación

70KBIW Enchufe con válvula, rosca hembra

Acero inoxidable, FKM

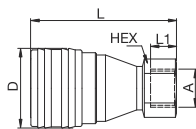

Di- men- sión	A		HEX	L	L1	D	Versión	Presión máxima de trabajo
1/8"	G1/8	71KBIW10RVX	14	48,5	7	25	AISI 303	250
	G1/4	72KBIW13RVX	19	57,5	10	29	AISI 303	250
1/4"	G1/4	72KBIW13EVX	19	57,5	10	29	AISI 316L	250
	G3/8	73KBIW17RVX	22	64	11,5	35	AISI 303	250
3/8"	G3/8	73KBIW17EVX	22	64	11,5	35	AISI 316L	250
1/2"	G1/2	74KBIW21RVX	27	76	16	44,5	AISI 303	250
	G1/2	74KBIW21EVX	27	76	16	44,5	AISI 316L	250
3/4"	G3/4	75KBIW26RVX	34	96	24	55	AISI 303	160
	G3/4	75KBIW26EVX	34	96	24	55	AISI 316L	160
1"	G1	76KBIW33RVX	41	105,5	24	62	AISI 303	100
	G1	76KBIW33EVX	41	105,5	24	62	AISI 316L	100

70SBIW Acoplador con válvula, rosca hembra

Acero inoxidable, FKM

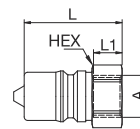

Di- men- sión	A		HEX	L	L1	Versión	Presión máxima de trabajo
1/8"	G1/8	71SBIW10RVX	14	29,5	7	AISI 303	250
	G1/4	72SBIW13RVX	19	35	10	AISI 303	250
1/4"	G1/4	72SBIW13EVX	19	35	10	AISI 316L	250
	G3/8	73SBIW17RVX	22	39	11,5	AISI 303	250
3/8"	G3/8	73SBIW17EVX	22	39	11,5	AISI 316L	250
1/2"	G1/2	74SBIW21RVX	27	48	16	AISI 303	250
	G1/2	74SBIW21EVX	27	48	16	AISI 316L	250
3/4"	G3/4	75SBIW26RVX	36	60	24	AISI 303	160
	G3/4	75SBIW26EVX	36	60	24	AISI 316L	160
1"	G1	76SBIW33RVX	41	65	24	AISI 303	100
	G1	76SBIW33EVX	41	65	24	AISI 316L	100

Serie 21 - Termoplástico

Diámetro nominal
5 = 20 mm²



Acoplamiento mini industrial en plásticos POM y PVDF con el perfil más popular del mundo en este diámetro nominal. Rendimiento de caudal superior a la media para medios líquidos y gaseosos. Sistema de acoplamiento con operación de una sola mano. Este nuevo tipo de sistema de cierre de plástico con manguito práctico amplía considerablemente las aplicaciones de esta serie. Dos formas de corredera - cónica y cilíndrica, donde la forma cónica de la corredera facilita la manipulación con guantes. El código de colores del acoplamiento y del tapón ofrece una garantía para evitar confusiones entre los medios al acoplarse.

- Tipos de válvulas disponibles:
- Simple obturación
 - Doble obturación

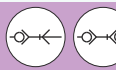

RectuPOM

Presión de trabajo*:
hasta 10 bar (POM, a 20°C)

Material:

- Enchufe: POM negro
- Acoplador: POM negro
- Junta: NBR

Temperatura de trabajo:
-20°C hasta +80°C (POM)

- Caudal de aire:

- Simple obturación: 550 l/min.
- Doble obturación: 310 l/min.

presión de entrada 6 bar, caída de presión 0,5 bar

Caudal de agua:

- Simple obturación: 7 l/min.
- Doble obturación: 2,7 l/min.

caída de presión de 0,5 bar

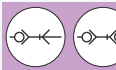

RectuChem

Presión de trabajo*:
hasta 8 bar (PVDF, a 20°C)

Material:

- Enchufe: PVDF blanco
- Acoplador: PVDF blanco
- Junta: FKM

Temperatura de trabajo:
-20°C hasta +120°C (PVDF)

- Caudal de aire:

- Simple obturación: 550 l/min.
- Doble obturación: 310 l/min.

presión de entrada 6 bar, caída de presión 0,5 bar

Caudal de agua:

- Simple obturación: 7 l/min.
- Doble obturación: 2,7 l/min.

caída de presión de 0,5 bar

* máxima presión estática de trabajo con un factor de diseño de 4 a 1.



Simple obturación/Doble obturación

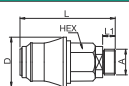
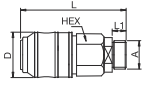

	conexión A	HEX	HEX1	L	L1	L2	D	B	G	El color del casquillo	Referencia POM	Referencia CHEM
 <p>21KBAW Enchufe con válvula, rosca macho casquillo cónico</p>	G1/8	17	50	7		25,5				Estándar	21KBAW10DPX	21KBAW10FVX
	G1/4	17	50	7		25,5				Estándar	21KBAW13DPX	21KBAW13FVX
 <p>21KBAW Enchufe con válvula, rosca macho casquillo cilíndrico</p>	G1/8	17	50	7		21			Azul	21KBAW10DPXGB	21KBAW10FVXGB	
	G1/8	17	50	7		21			Rojo	21KBAW10DPXGR	21KBAW10FVXGR	
	G1/8	17	50	7		21			Estándar	21KBAW10DPXG	21KBAW10FVXG	
	G1/4	17	50	7		21			Azul	21KBAW13DPXGB	21KBAW13FVXGB	
	G1/4	17	50	7		21			Rojo	21KBAW13DPXGR	21KBAW13FVXGR	
	G1/4	17	50	7		21			Estándar	21KBAW13DPXG	21KBAW13FVXG	

Serie 21 - Termoplástico

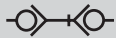
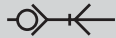

Simple obturación/Doble obturación



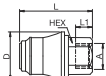
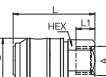
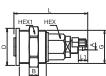
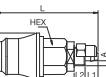
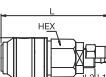

	conexión A	HEX	HEX1	L	L1	L2	D	B	G	El color del casquillo	Referencia POM	Referencia CHEM
 21KBIW Enchufe con válvula, rosca hembra casquillo cónico	G1/8	17	53	8			25,5			Estándar	21KBIW10DPX	21KBIW10FVX
	G1/4	17	39	9			25,5			Estándar	21KBIW13DPX	21KBIW13FVX
 21KBIW Enchufe con válvula, rosca hembra casquillo cilíndrico	G1/8	17	53	8			21			Azul	21KBIW10DPXGB	21KBIW10FVXGB
	G1/8	17	53	8			21			Rojo	21KBIW10DPXGR	21KBIW10FVXGR
	G1/8	17	53	8			21			Estándar	21KBIW10DPXG	21KBIW10FVXG
	G1/4	17	39	9			21			Azul	21KBIW13DPXGB	21KBIW13FVXGB
	G1/4	17	39	9			21			Rojo	21KBIW13DPXGR	21KBIW13FVXGR
	G1/4	17	39	9			21			Estándar	21KBIW13DPXG	21KBIW13FVXG
 21KBKE Coupleur à obturation à traversée de cloison pour tuyaux plastique	4 x 6	17	27	56	7	20,5	28	7	M25x1	Estándar	21KBKE06DPX	21KBKE06FVX
	6 x 8	17	27	56	7	20,5	28	7	M25x1	Estándar	21KBKE08DPX	21KBKE08FVX
 21KBKO Enchufe con válvula, conexión manguera Plástica, casquillo cónico	4 x 6	17	56	6	7	25,5			M10x1	Estándar	21KBK006DPX	21KBK006FVX
	6 x 8	17	56	6	7	25,5			M12x1	Estándar	21KBK008DPX	21KBK008FVX
 21KBKO Enchufe con válvula, conexión manguera Plástica, casquillo cilíndrico	4 x 6	17	56	6	7	21				Azul	21KBK006DPXGB	21KBK006FVXGB
	4 x 6	17	56	6	7	21				Rojo	21KBK006DPXGR	21KBK006FVXGR
	4 x 6	17	56	6	7	21				Estándar	21KBK006DPXG	21KBK006FVXG
	6 x 8	17	56	6	7	21				Azul	21KBK008DPXGB	21KBK008FVXGB
	6 x 8	17	56	6	7	21				Rojo	21KBK008DPXGR	21KBK008FVXGR
	6 x 8	17	56	6	7	21				Estándar	21KBK008DPXG	21KBK008FVXR

Serie 21 - Termoplástico



Simple obturación/Doble obturación

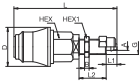
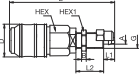

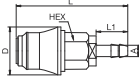
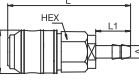
	conexión A	HEX	HEX1	L	L1	L2	D	B	G	El color del casquillo	Referencia POM	Referencia CHEM
 <p>21KBKS Enchufe con válvula.montaje en panel, conexión manguera de plástico casquillo cónico</p>	4 x 6	17	14	68	7	18	25,5	4	M10x1	Estándar	21KBKS06DPX	21KBKS06FVX
	6 x 8	17	17	68	7	18	25,5	4	M12x1	Estándar	21KBKS08DPX	21KBKS08FVX
 <p>21KBKS Enchufe con válvula.montaje en panel, conexión manguera de plástico casquillo cilíndrico</p>	4 x 6	17	14	68	7	18	21	4	M10x1	Azul	21KBKS06DPXGB	21KBKS06FVXGB
	4 x 6	17	14	68	7	18	21	4	M10x1	Rojo	21KBKS06DPXGR	21KBKS06FVXGR
	4 x 6	17	14	68	7	18	21	4	M10x1	Estándar	21KBKS06DPXG	21KBKS06FVXG
	6 x 8	17	17	68	7	18	21	4	M12x1	Azul	21KBKS08DPXGB	21KBKS08FVXGB
	6 x 8	17	17	68	7	18	21	4	M12x1	Rojo	21KBKS08DPXGR	21KBKS08FVXGR
	6 x 8	17	17	68	7	18	21	4	M12x1	Estándar	21KBKS08DPXG	21KBKS08FVXG
 <p>21KBTE Enchufe con válvula, montaje en panel conexión manguera</p>	4	17	27	60	17	20,5	28	7	M25x1	Estándar	21KBTE04DPX	21KBTE04FVX
	6	17	27	60	17	20,5	28	7	M25x1	Estándar	21KBTE06DPX	21KBTE06FVX
 <p>21KBTF Enchufe con válvula, conexión manguera casquillo cónico</p>	4	17		60	17		25,5			Estándar	21KBTF04DPX	21KBTF04FVX
	6	17		60	17		25,5			Estándar	21KBTF06DPX	21KBTF06FVX
 <p>21KBTF Enchufe con válvula, conexión manguera casquillo cilíndrico</p>	4	17		60	17		21			Azul	21KBTF04DPXGB	21KBTF04FVXGB
	4	17		60	17		21			Rojo	21KBTF04DPXGR	21KBTF04FVXGR
	4	17		60	17		21			Estándar	21KBTF04DPXG	21KBTF04FVXG
	6	17		60	17		21			Azul	21KBTF06DPXGB	21KBTF06FVXGB
	6	17		60	17		21			Rojo	21KBTF06DPXGR	21KBTF06FVXGR
	6	17		60	17		21			Estándar	21KBTF06DPXG	21KBTF06FVXG

Serie 21 - Termoplástico

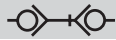

Simple obturación/Doble obturación



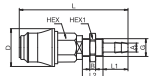
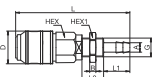

	conexión A	HEX	HEX1	L	L1	L2	D	B	G	El color del casquillo	Referencia POM	Referencia CHEM
 <p>21KBS Enchufe con válvula. montaje en panel, conexión manguera casquillo cónico</p>	4	17	14	74	17	14	25,5	4	M10x1	Estándar	21KBS04DPX	21KBS04FVX
	6	17	14	74	17	14	25,5	4	M10x1	Estándar	21KBS06DPX	21KBS06FVX
 <p>21KBS Enchufe con válvula. montaje en panel, conexión manguera casquillo cilíndrico</p>	4	17	14	74	17	14	21	4	M10x1	Azul	21KBS04DPXGB	21KBS04FVXGB
	4	17	14	74	17	14	21	4	M10x1	Rojo	21KBS04DPXGR	21KBS04FVXGR
	4	17	14	74	17	14	21	4	M10x1	Estándar	21KBS04DPXG	21KBS04FVXG
	6	17	17	74	17	14	21	4	M12x1	Azul	21KBS06DPXGB	21KBS06FVXGB
	6	17	17	74	17	14	21	4	M12x1	Rojo	21KBS06DPXGR	21KBS06FVXGR
	6	17	17	74	17	14	21	4	M12x1	Estándar	21KBS06DPXG	21KBS06FVXG



Simple obturación

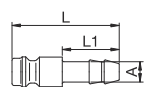

	conexión A	HEX	HEX1	L	L1	L2	D	B	G	El color del casquillo	Referencia POM	Referencia CHEM
 <p>21SFAW Acoplador sin válvula, rosca macho</p>	G1/4	17		28	9					Estándar	21SFAW13DXX	21SFAW13FXX
	G1/4	17		25	9					Azul	21SFIW13DXXB	21SFIW13FXXB
 <p>21SFIW Acoplador sin válvula, rosca hembra</p>	G1/4	17		25	9					Rojo	21SFIW13DXXR	21SFIW13FXXR
	G1/4	17		25	9					Estándar	21SFIW13DXX	21SFIW13FXX
 <p>21SFTF Acoplador sin válvula, conexión manguera</p>	4			32	17					Estándar	21SFTF04DXX	21SFTF04FXX
	6			32	17					Estándar	21SFTF06DXX	21SFTF06FXX

Serie 21 - Termoplástico

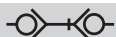

Simple obturación/Doble obturación

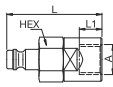
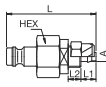

	conexión A	HEX	HEX1	L	L1	L2	D	B	G	El color del casquillo	Referencia POM	Referencia CHEM
 <p>21SBAW Acoplador con válvula, rosca macho</p>	G1/8	17	36	7						Azul	21SBAW10DPXB	21SBAW10FVXB
	G1/8	17	36	7						Rojo	21SBAW10DPXR	21SBAW10FVXR
	G1/8	17	36	7						Estándar	21SBAW10DPX	21SBAW10FVX
	G1/4	17	38	7						Azul	21SBAW13DPXB	21SBAW13FVXB
	G1/4	17	38	7						Rojo	21SBAW13DPXR	21SBAW13FVXR
	G1/4	17	38	7						Estándar	21SBAW13DPX	21SBAW13FVX
 <p>21SBIW Acoplador con válvula, rosca hembra</p>	G1/8	17	39	8						Azul	21SBIW10DPXB	21SBIW10FVXB
	G1/8	17	39	8						Rojo	21SBIW10DPXR	21SBIW10FVXR
	G1/8	17	39	8						Estándar	21SBIW10DPX	21SBIW10FVX
	G1/4	17	42	10						Azul	21SBIW13DPXB	21SBIW13FVXB
	G1/4	17	42	10						Rojo	21SBIW13DPXR	21SBIW13FVXR
	G1/4	17	42	10						Estándar	21SBIW13DPX	21SBIW13FVX
 <p>21SBK0 Acoplador con válvula, con conexión de manguera de plástico</p>	4 x 6	17	42	7	6					Azul	21SBK006DPXB	21SBK006FVXB
	4 x 6	17	42	7	6					Rojo	21SBK006DPXR	21SBK006FVXR
	4 x 6	17	42	7	6					Estándar	21SBK006DPX	21SBK006FVX
	6 x 8	17	42	7	6					Azul	21SBK008DPXB	21SBK008FVXB
	6 x 8	17	42	7	6					Rojo	21SBK008DPXR	21SBK008FVXR
	6 x 8	17	42	7	6					Estándar	21SBK008DPX	21SBK008FVX

Serie 21 - Termoplástico

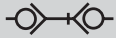

Simple obturación/Doble obturación

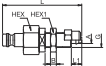
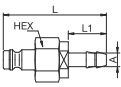
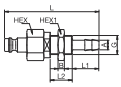

	conexión A	HEX	HEX1	L	L1	L2	D	B	G	El color del casquillo	Referencia POM	Referencia CHEM
 21SBKS Acoplador con válvula, montaje en panel con conexión de manguera plástica	4 x 6	17	14	54	7	18		4	M10x1	Azul	21SBKS06DPXB	21SBKS06FVXB
	4 x 6	17	14	54	7	18		4	M10x1	Rojo	21SBKS06DPXR	21SBKS06FVXR
	4 x 6	17	14	54	7	18		4	M10x1	Estándar	21SBKS06DPX	21SBKS06FVX
	6 x 8	17	17	54	7	18		4	M12x1	Azul	21SBKS08DPXB	21SBKS08FVXB
	6 x 8	17	17	54	7	18		4	M12x1	Rojo	21SBKS08DPXR	21SBKS08FVXR
	6 x 8	17	17	54	7	18		4	M12x1	Estándar	21SBKS08DPX	21SBKS08FVX
 21SBTF Acoplador con válvula, conexión manguera	4	17		46	17					Estándar	21SBTF04DPX	21SBTF04FVX
	4	17		46	17					Azul	21SBTF04DPXB	21SBTF04FVXB
	4	17		46	17					Rojo	21SBTF04DPXR	21SBTF04FVXR
	6	17		46	17					Estándar	21SBTF06DPX	21SBTF06FVX
	6	17		46	17					Azul	21SBTF06DPXB	21SBTF06FVXB
	6	17		46	17					Rojo	21SBTF06DPXR	21SBTF06FVXR
 21SBTS Acoplador con válvula, montaje en panel con manguera	4	17	14	60	7	14		4	M10x1	Azul	21SBTS04DPXB	21SBTS04FVXB
	4	17	14	60	7	14		4	M10x1	Rojo	21SBTS04DPXR	21SBTS04FVXR
	4	17	14	60	7	14		4	M10x1	Estándar	21SBTS04DPX	21SBTS04FVX
	6	17	17	60	7	14		4	M12x1	Azul	21SBTS06DPXB	21SBTS06FVXB
	6	17	17	60	7	14		4	M12x1	Rojo	21SBTS06DPXR	21SBTS06FVXR
	6	17	17	60	7	14		4	M12x1	Estándar	21SBTS06DPX	21SBTS06FVX

Serie 48 - Termoplástico

Diámetro nominal
7 = 38 mm²



Se han desarrollado series de acoplamientos hechos de POM y PVDF para su uso en las industrias médica, química, de manipulación de alimentos, farmacéutica y de tecnología de laboratorio. El sistema también está disponible en un diseño de plástico sólido (RectuChem +). En este caso, los muelles metálicos se sustituyen por muelles de PEEK, un material sintético extremadamente resistente. Sistema de acoplamiento con manejo con una sola mano. La codificación por colores del acoplamiento y el tapón ofrece una garantía para evitar confusiones entre los medios al acoplar. El acoplamiento también está disponible sin válvula para un sistema de paso directo.

- Tipos de válvulas disponibles:

- Simple obturación
- Doble obturación

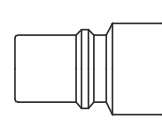

RectuPOM

Presión de trabajo*:
hasta 10 bar (POM, a 20°C)

Material:

- Enchufe: POM negro
- Acoplador: POM negro
- Junta: NBR

Temperatura de trabajo:
-20°C hasta +80°C (POM)

-Caudal de aire:

- Simple obturación: 1.100 l/min.
 - Doble obturación: 770 l/min.
- presión de entrada 6 bar, caída de presión 0,5 bar

Caudal de agua:

- Simple obturación: 17 l/min.
 - Doble obturación: 12 l/min.
- caída de presión de 0,5 bar

RectuChem

Presión de trabajo*:
hasta 8 bar (PVDF, con muelles metálicos)

Material:

- Enchufe: PVDF blanco
- Acoplador: PVDF blanco
- Junta: FKM

Temperatura de trabajo:
-20°C hasta +120°C (PVDF)

-Caudal de aire:

- Simple obturación: 1.100 l/min.
 - Doble obturación: 770 l/min.
- presión de entrada 6 bar, caída de presión 0,5 bar

Caudal de agua:

- Simple obturación: 17 l/min.
 - Doble obturación: 12 l/min.
- caída de presión de 0,5 bar

RectuChem+

Presión de trabajo*:
1-8 bar (PVDF, con muelle PEEK)

Material:

- Enchufe: PVDF blanco, muelle PEEK
- Acoplador: PVDF blanco, muelle PEEK
- Junta: FKM

Temperatura de trabajo:
-20°C hasta +120°C (PVDF)

Caudal de aire:

- Doble obturación: 770 l/min
- presión de entrada 6 bar, caída de presión 0,5 bar

Caudal de agua:

- Doble obturación: 12 l/min.
- caída de presión de 0,5 bar

* máxima presión estática de trabajo con un factor de diseño de 4 a 1.



Simple obturación/Doble obturación

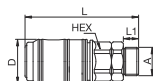

48KBAW

Enchufe con válvula, rosca macho

conexión A	HEX	L	L1	D	El color del casquillo	Referencia POM	Referencia CHEM	Referencia CHEM+
G1/4	21	70,5	9	26	Estándar	48KBAW13DPX	48KBAW13FVX	48KBAW13FVP
G1/4	21	70,5	9	26	Rojo	48KBAW13DPXR	48KBAW13FVXR	48KBAW13FVPR
G1/4	21	70,5	9	26	Azul	48KBAW13DPXB	48KBAW13FVXB	48KBAW13FVPB
G3/8	21	67	9	26	Estándar	48KBAW17DPX	48KBAW17FVX	48KBAW17FVP
G3/8	21	67	9	26	Rojo	48KBAW17DPXR	48KBAW17FVXR	48KBAW17FVPR
G3/8	21	67	9	26	Azul	48KBAW17DPXB	48KBAW17FVXB	48KBAW17FVPB
G1/2	21	73,5	12	26	Estándar	48KBAW21DPX	48KBAW21FVX	48KBAW21FVP
G1/2	21	73,5	12	26	Rojo	48KBAW21DPXR	48KBAW21FVXR	48KBAW21FVPR
G1/2	21	73,5	12	26	Azul	48KBAW21DPXB	48KBAW21FVXB	48KBAW21FVPB

Serie 48 - Termoplástico

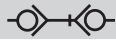

Simple obturación/Doble obturación



conexión A	HEX	L	L1	D	El color del casquillo	Referencia POM	Referencia CHEM	Referencia CHEM+
G1/4	21	63,5	10	26	Estándar	48KBIW13DPX	48KBIW13FVX	48KBIW13FVP
G1/4	21	63,5	10	26	Rojo	48KBIW13DPXR	48KBIW13FVXR	48KBIW13FVPR
G1/4	21	63,5	10	26	Azul	48KBIW13DPXB	48KBIW13FVXB	48KBIW13FVPB
G3/8	21	63,5	13	26	Estándar	48KBIW17DPX	48KBIW17FVX	48KBIW17FVP
G3/8	21	63,5	13	26	Rojo	48KBIW17DPXR	48KBIW17FVXR	48KBIW17FVPR
G3/8	21	63,5	13	26	Azul	48KBIW17DPXB	48KBIW17FVXB	48KBIW17FVPB
G1/2	21	74,5	13	26	Estándar	48KBIW21DPX	48KBIW21FVX	48KBIW21FVP
G1/2	21	74,5	13	26	Rojo	48KBIW21DPXR	48KBIW21FVXR	48KBIW21FVPR
G1/2	21	74,5	13	26	Azul	48KBIW21DPXB	48KBIW21FVXB	48KBIW21FVPB
6	21	81	22	26	Estándar	48KBTf06DPX	48KBTf06FVX	48KBTf06FVP
6	21	81	22	26	Rojo	48KBTf06DPXR	48KBTf06FVXR	48KBTf06FVPR
6	21	81	22	26	Azul	48KBTf06DPXB	48KBTf06FVXB	48KBTf06FVPB
9	21	81	22	26	Estándar	48KBTf09DPX	48KBTf09FVX	48KBTf09FVP
9	21	81	22	26	Rojo	48KBTf09DPXR	48KBTf09FVXR	48KBTf09FVPR
9	21	81	22	26	Azul	48KBTf09DPXB	48KBTf09FVXB	48KBTf09FVPB
13	21	84	25	26	Estándar	48KBTf13DPX	48KBTf13FVX	48KBTf13FVP
13	21	84	25	26	Rojo	48KBTf13DPXR	48KBTf13FVXR	48KBTf13FVPR
13	21	84	25	26	Azul	48KBTf13DPXB	48KBTf13FVXB	48KBTf13FVPB

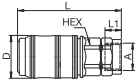

48KBIW

Enchufe con válvula, rosca hembra

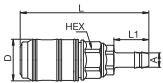

48KBTf

Enchufe con válvula, conexión manguera

Serie 48 - Termoplástico

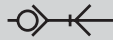

Simple obturación



	conexión A	HEX	L	L1	D	El color del casquillo	Referencia POM	Referencia CHEM	Referencia CHEM+
 48SAW Acoplador sin válvula, rosca macho	G3/8	21	38,5	9		Estándar	48SAW17DXX	48SAW17FXX	
	G3/8	21	35,5	10		Estándar	48SAW17DXX	48SAW17FXX	
 48SFIW Acoplador sin válvula, rosca hembra	G3/8	21	35,5	10		Rojo	48SFIW17DXXR	48SFIW17FXXR	
	G3/8	21	35,5	10		Azul	48SFIW17DXXB	48SFIW17FXXB	
	G3/8	21	35,5	10		Azul	48SFIW17DXXB	48SFIW17FXXB	
 48SFTF Acoplador sin válvula, conexión manguera	9		47	22	18	Estándar	48SFTF09DXX	48SFTF09FXX	



Simple obturación/Doble obturación

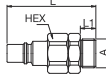

	conexión A	HEX	L	L1	D	El color del casquillo	Referencia POM	Referencia CHEM	Referencia CHEM+
 48SBAW Acoplador con válvula, rosca macho	G1/4	21	55	9		Estándar	48SBAW13DPX	48SBAW13FVX	48SBAW13DPX
	G1/4	21	55	9		Rojo	48SBAW13DPXR	48SBAW13FVXR	48SBAW13DPX
	G1/4	21	55	9		Azul	48SBAW13DPXB	48SBAW13FVXB	48SBAW13DPX
	G3/8	21	51,5	9		Estándar	48SBAW17DPX	48SBAW17FVX	48SBAW17FVP
	G3/8	21	51,5	9		Rojo	48SBAW17DPXR	48SBAW17FVXR	48SBAW17FVPR
	G3/8	21	51,5	9		Azul	48SBAW17DPXB	48SBAW17FVXB	48SBAW17FVPB
	G1/2	21	58	12		Estándar	48SBAW21DPX	48SBAW21FVX	48SBAW21FVP
	G1/2	21	58	12		Rojo	48SBAW21DPXR	48SBAW21FVXR	48SBAW21FVPR
	G1/2	21	58	12		Azul	48SBAW21DPXB	48SBAW21FVXB	48SBAW21FVPB

Serie 48 - Termoplástico

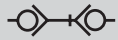

Simple obturación/Doble obturación



conexión A	HEX	L	L1	D	El color del casquillo	Referencia POM	Referencia CHEM	Referencia CHEM+
G1/4	21	48	10		Estándar	48SBIW13DPX	48SBIW13FVX	48SBIW13FVP
G1/4	21	48	10		Rojo	48SBIW13DPXR	48SBIW13FVXR	48SBIW13FVPR
G1/4	21	48	10		Azul	48SBIW13DPXB	48SBIW13FVXB	48SBIW13FVPB
G3/8	21	48	10		Estándar	48SBIW17DPX	48SBIW17FVX	48SBIW17FVP
G3/8	21	48	10		Rojo	48SBIW17DPXR	48SBIW17FVXR	48SBIW17FVPR
G3/8	21	48	10		Azul	48SBIW17DPXB	48SBIW17FVXB	48SBIW17FVPB
G1/2	21	59	13		Estándar	48SBIW21DPX	48SBIW21FVX	48SBIW21FVP
G1/2	21	59	13		Rojo	48SBIW21DPXR	48SBIW21FVXR	48SBIW21FVPR
G1/2	21	59	13		Azul	48SBIW21DPXB	48SBIW21FVXB	48SBIW21FVPB
6	21	65,5	22		Estándar	48SBTF06DPX	48SBTF06FVX	48SBTF06FVP
6	21	65,5	22		Rojo	48SBTF06DPXR	48SBTF06FVXR	48SBTF06FVPR
6	21	65,5	22		Azul	48SBTF06DPXB	48SBTF06FVXB	48SBTF06FVPB
9	21	65,5	22		Estándar	48SBTF09DPX	48SBTF09FVX	48SBTF09FVP
9	21	65,5	22		Rojo	48SBTF09DPXR	48SBTF09FVXR	48SBTF09FVPR
9	21	65,5	22		Azul	48SBTF09DPXB	48SBTF09FVXB	48SBTF09FVPB
13	21	68,5	25		Estándar	48SBTF13DPX	48SBTF13FVX	48SBTF13FVP
13	21	68,5	25		Rojo	48SBTF13DPXR	48SBTF13FVXR	48SBTF13FVPR
13	21	68,5	25		Azul	48SBTF13DPXB	48SBTF13FVXB	48SBTF13FVPB

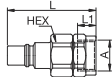

48SBIW

Acoplador con válvula, rosca hembra

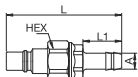

48SBTF

Acoplador con válvula, conexión manguera

Serie 70 - Termoplástico

Diámetro nominal
4,3 - 20



Los acoplamientos varían en tamaños de 1/8" a 1" con perfil de enchufe de acuerdo con la norma ISO 7241-1 serie B. Especialmente adecuado para su uso con medios líquidos. Sistema de acoplamiento con accionamiento a dos manos, es decir, el casquillo de cierre debe ser empujado hacia atrás manualmente al acoplar. La gama de acoplamientos se caracteriza por sus altos caudales frente a una baja caída de presión.

- Tipo de válvula disponible:
 - Doble obturación

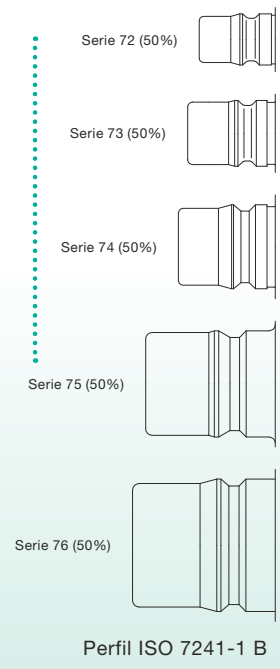

RectuPOM

Presión de trabajo*:
ver tabla

Material:

- Enchufe: POM blanco
- Acoplador: POM blanco
- Junta: NBR

Temperatura de trabajo:
-20°C hasta +90°C (NBR)

- Caudal de agua:**
- Serie 72: 9 l/min.
 - Serie 73: 17 l/min.
 - Serie 74: 33 l/min.
 - Serie 75: 79 l/min.
 - Serie 76: 117 l/min.
- caída de presión de 0,5 bar

* máxima presión estática de trabajo con un factor de diseño de 4 a 1.

02 // Enchufes automáticos

Termoplástico

Serie 70

Doble obturación

Doble obturación

70KBIW Enchufe con válvula, rosca hembra

POM, NBR

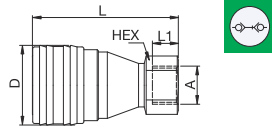

Di-men-sión	A		HEX	L	L1	D	Presión máxima de trabajo
1/8"	G1/8	71KBIW10DPX	14	48,5	7	25	15
1/4"	G1/4	72KBIW13DPX	19	57,5	10	29	15
3/8"	G3/8	73KBIW17DPX	22	64	11,5	35	15
1/2"	G1/2	74KBIW21DPX	27	76	16	44,5	10
3/4"	G3/4	75KBIW26DPX	34	96	24	55	10
1"	G1	76KBIW33DPX	41	105,5	24	62	10

70SBIW Acoplador con válvula, rosca hembra

POM, NBR

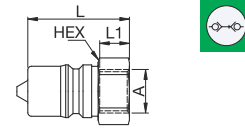

Di-men-sión	A		HEX	L	L1	Presión máxima de trabajo
1/8"	G1/8	71SBIW10DPX	14	29,5	7	15
1/4"	G1/4	72SBIW13DPX	19	35	10	15
3/8"	G3/8	73SBIW17DPX	22	39	11,5	15
1/2"	G1/2	74SBIW21DPX	27	48	16	10
3/4"	G3/4	75SBIW26DPX	36	60	24	10
1"	G1	76SBIW33DPX	41	56	24	10

Accesorios

DN Unión igual, rosca macho

POM o CHEM

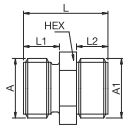

A	A1		HEX	L	L1	L2	Versión
G1/4	G1/8	DN13/10DX	14	19	8	7	POM
	G1/4	DN13/13DX	14	19	8	7	POM
	G1/4	DN17/13DX	17	28,5	9	9	POM
G3/8	G3/8	DN17/17DX	21	25	9	9	POM
	G1/2	DN17/21DX	21	31,5	9	12	POM
G1/4	G1/8	DN13/10FX	14	19	8	7	CHEM
	G1/4	DN13/13FX	14	19	8	7	CHEM
	G1/4	DN17/13FX	17	28,5	9	9	CHEM
G3/8	G3/8	DN17/17FX	21	25	9	9	CHEM
	G1/2	DN17/21FX	21	31,5	9	12	CHEM

ET montaje en panel, conexión de manguera estándar

POM o CHEM

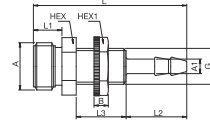

A		HEX	HEX1	B	G	L	L1	L2	Versión	
G1/4		ET13/04DX	14	14	4	M10x1	43	7	8	POM
		ET13/06DX	14	17	4	M12x1	43	8	8	POM
		ET13/04FX	14	14	4	M10x1	43	7	8	CHEM
		ET13/06FX	14	17	4	M12x1	43	8	8	CHEM

RL Reductor

POM o CHEM

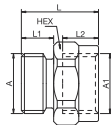

A	A1		HEX	L	L1	L2	Versión
G1/4	G1/8	RL13/10DX	14	22	8	8	POM
	G1/4	RL13/13DX	17	25	8	10	POM
	G1/4	RL17/13DX	17	21,5	9	10	POM
G3/8	G3/8	RL17/17DX	21	21,5	9	10	POM
	G1/2	RL17/21DX	17	32,5	9	13	POM
G1/4	G1/8	RL13/10FX	14	22	8	8	CHEM
	G1/4	RL13/13FX	17	25	8	10	CHEM
	G1/4	RL17/13FX	17	21,5	9	10	CHEM
G3/8	G3/8	RL17/17FX	21	21,5	9	10	CHEM
	G1/2	RL17/21FX	17	32,5	9	13	CHEM

GT Espiga acanalada para manguera

POM o CHEM

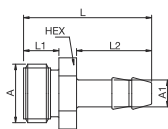

A	A1		HEX	L	L1	L2	Versión
G1/4	4	GT13/04DX	14	29	8	17	POM
	6	GT13/06DX	14	29	8	17	POM
	6	GT17/06DX	17	39	9	22	POM
G3/8	9	GT17/09DX	17	39	9	22	POM
	13	GT17/13DX	17	42	9	25	POM
G1/4	4	GT13/04FX	14	29	8	17	CHEM
	6	GT13/06FX	14	29	8	17	CHEM
	6	GT17/06FX	17	39	9	22	CHEM
G3/8	9	GT17/09FX	17	39	9	22	CHEM
	13	GT17/13FX	17	42	9	25	CHEM

Serie 200 - Doble obturación sin goteo

Diámetro nominal
4/6/9



Sistema de acoplamiento en seco para aplicaciones en entornos sensibles, por ejemplo en la tecnología de análisis, en sistemas de refrigeración, en sistemas de transporte y en muchas aplicaciones con medios agresivos.
Sistema de acoplamiento con una sola mano, con tasas de fuga extremadamente bajas y un volumen mínimo de espacio muerto. No hay absolutamente ninguna bolsa de aire al acoplar y sólo una película apenas perceptible del medio que se canaliza en los cuerpos de las válvulas al desacoplar. Diseño ergonómico de la corredera. Bajas fuerzas de acoplamiento. Cuerpo de la válvula protegido por el diseño del cuello.

- Disponible a petición:
 - otras juntas para diferentes rangos de temperatura y fluidos

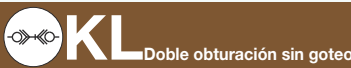
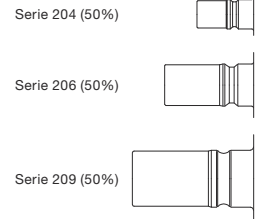

Presión de trabajo*:
hasta 15 bar

Material:

- Enchufe: Latón niquelado o AISI 316L
- Acoplador: Latón niquelado o AISI 316L
- Junta: NBR o FKM

Temperatura de trabajo:

- 20°C hasta +100°C (NBR)
- 15°C hasta +200°C (FKM)

Caudal de agua:

- Serie 204: 4,5 l/min.
- Serie 206: 8,9 l/min.
- Serie 209: 27 l/min.

caída de presión de 0,5 bar

* máxima presión estática de trabajo con un factor de diseño de 4 a 1.

 Sin goteo

200KLAW Enchufe con válvula, rosca macho

Latón niquelado o acero inoxidable, NBR o FKM

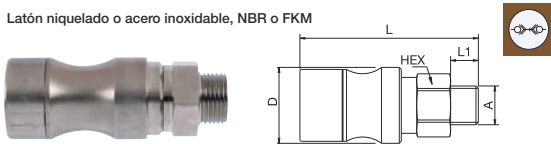

DN	A	HEX	L	L1	D	Versión	
4	G1/8	204KLAW10MPN	14	45	7	19	Latón niquelado
	G1/8	204KLAW10EVX	14	45	7	19	AISI 316L
	G1/4	204KLAW13MPN	17	47	9	19	Latón niquelado
	G1/4	204KLAW13EVX	17	47	9	19	AISI 316L
6	G3/8	206KLAW17MPN	22	69	9	25,5	Latón niquelado
	G3/8	206KLAW17EVX	22	69	9	25,5	AISI 316L
	G1/2	206KLAW21MPN	22	72	12	25,5	Latón niquelado
	G1/2	206KLAW21EVX	24	72	12	25,5	AISI 316L

 Sin goteo

200KLIW Enchufe con válvula, rosca hembra

Latón niquelado o acero inoxidable, NBR o FKM



DN	A	HEX	L	L1	D	Versión	
4	G1/8	204KLIW10MPN	14	45	9	19	Latón niquelado
	G1/8	204KLIW10EVX	14	45	9	19	AISI 316L
	G1/4	204KLIW13MPN	17	47	9	19	Latón niquelado
	G1/4	204KLIW13EVX	17	47	9	19	AISI 316L
6	G3/8	206KLIW17MPN	22	69	7	25,5	Latón niquelado
	G3/8	206KLIW17EVX	22	69	9	25,5	AISI 316L
	G1/2	206KLIW21MPN	24	72	10	25,5	Latón niquelado
	G1/2	206KLIW21EVX	24	72	12	25,5	AISI 316L
9	G1/2	209KLIW21MPN	27	92	14	33	Latón niquelado
	G1/2	209KLIW21EVX	27	92	16	33	AISI 316L
	G3/4	209KLIW26MPN	32	94	14	33	Latón niquelado
	G3/4	209KLIW26EVX	32	94	16	33	AISI 316L

Serie 200 - Doble obturación sin goteo



Sin goteo

200SLAW Acoplador con válvula, rosca macho

Latón niquelado o acero inoxidable, NBR o FKM

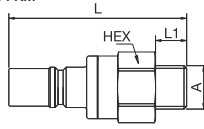

DN	A		HEX	L	L1	Versión
4	G1/8	204SLAW10MPN	14	40	7	Latón niquelado
	G1/8	204SLAW10EVX	14	40	7	AISI 316L
	G1/4	204SLAW13MPN	17	42	9	Latón niquelado
	G1/4	204SLAW13EVX	17	42	9	AISI 316L
6	G3/8	206SLAW17MPN	22	51	9	Latón niquelado
	G3/8	206SLAW17EVX	22	55	9	AISI 316L
	G1/2	206SLAW21MPN	22	54	12	Latón niquelado
	G1/2	206SLAW21EVX	24	54	12	AISI 316L

200SLIW Acoplador con válvula, rosca hembra

Latón niquelado o acero inoxidable, NBR o FKM

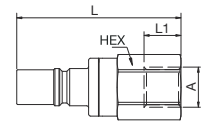

DN	A		HEX	L	L1	Versión
4	G1/8	204SLIW10MPN	14	40	9	Latón niquelado
	G1/8	204SLIW10EVX	14	40	9	AISI 316L
	G1/4	204SLIW13MPN	17	42	7	Latón niquelado
	G1/4	204SLIW13EVX	17	42	9	AISI 316L
6	G3/8	206SLIW17MPN	22	51	7	Latón niquelado
	G3/8	206SLIW17EVX	22	51	9	AISI 316L
	G1/2	206SLIW21MPN	24	54	10	Latón niquelado
	G1/2	206SLIW21EVX	24	54	12	AISI 316L
9	G1/2	209SLIW21MPN	27	80	14	Latón niquelado
	G1/2	209SLIW21EVX	27	80	16	AISI 316L
	G3/4	209SLIW26MPN	32	82	14	Latón niquelado
	G3/4	209SLIW26EVX	32	82	16	AISI 316L

Serie 200 - Doble obturación sin goteo - Acoplamientos de cartuchos

Diámetro nominal
3-12



Acoplamientos de cartuchos de rotura en seco sin mecanismo de bloqueo de acero inoxidable. Disponibles en cinco tamaños diferentes para el ensamblaje de bloque modular/placa en entornos sensibles. Se pueden combinar diferentes tamaños de acoplamiento en un multiacoplamiento, dependiendo de los requisitos de la aplicación.



OKL Doble obturación sin goteo

Presión de trabajo*:
hasta 15 bar

Material:

- Enchufe: Latón niquelado o acero inoxidable
- Acoplador: Latón niquelado o acero inoxidable
- Junta: NBR o FKM

Temperatura de trabajo:

- 20°C hasta +100°C (NBR)
- 15°C hasta +200°C (FKM)

Caudal de agua:

- Serie 203: 1,2 l/min.
 - Serie 204: 4,5 l/min.
 - Serie 206: 8,9 l/min.
 - Serie 209: 27 l/min.
 - Serie 212: 32 l/min.
- caída de presión de 0,5 bar

* máxima presión estática de trabajo con un factor de diseño de 4 a 1.



Sin goteo

200KLIWEK Enchufe con válvula, rosca hembra

Acero inoxidable AISI 316 L, FKM

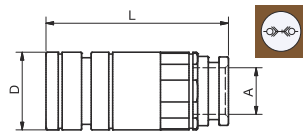
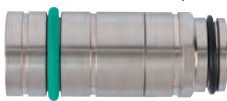

DN	A		L	D
3	G1/16	203KLIW08EVXEK	23	11
4	G1/8	204KLIW10EVXEK	35	16
6	G1/4	206KLIW13EVXEK	54	21
9	G3/8	209KLIW17EVXEK	59	25
12	G1/2	212KLIW21EVXEK	71	32



Sin goteo

200SLIWEK Acoplador con válvula, rosca hembra

Acero inoxidable AISI 316 L, FKM

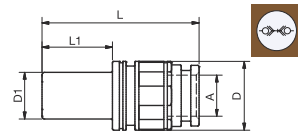

DN	A		L	L1	D	D1
3	G1/16	203SLIW08EVXEK	30	12	11	5,3
4	G1/8	204SLIW10EVXEK	42	15	16	8,4
6	G1/4	206SLIW13EVXEK	51	19	21	12,5
9	G3/8	209SLIW17EVXEK	56	26	25	17
12	G1/2	212SLIW21EVXEK	70	28	30	20

Serie 200 - Doble obturación sin goteo - Acoplamientos de cartuchos

Ensamblaje de bloques

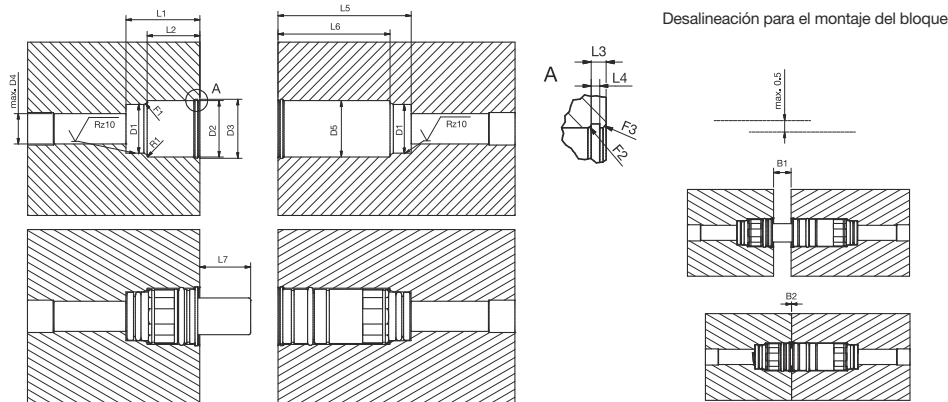

Ensamblaje de la placa

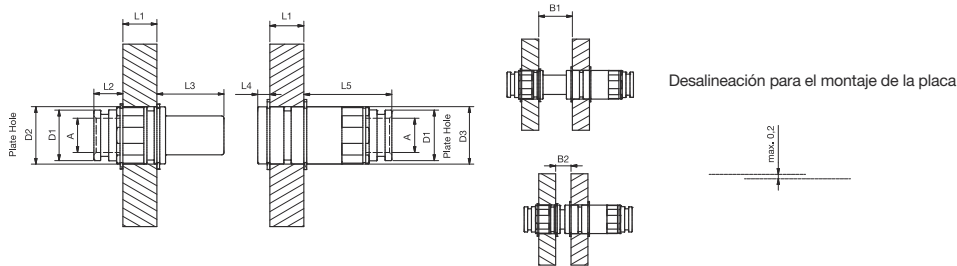

Montaje en bloque

DN mm	L1 mm	L2 mm	L3 mm	L4 mm	L5 mm	L6 mm	L7 mm	D1 mm	D2 mm	D3 mm	D4 max. mm	D5 mm	R1 max. mm	F1	F2	F3	B1	B2
3	20,10	14,90	2,10	1,10	24,80	19,60	9,60	10,00	12,00	12,50	8,00	12,00	0,50	1,0x30°	-	0,5x45°	5,00	0
4	29,00	22,50	2,10	1,10	37,80	31,35	13,00	14,00	17,00	17,80	10,00	17,00	0,50	1,2x30°	0,5x30°	0,5x45°	8,65	0
6	34,25	26,65	2,10	1,10	55,80	48,20	17,00	18,50	22,00	23,00	12,00	22,00	0,50	1,3x30°	0,5x30°	0,5x45°	11,40	0
9	33,80	24,30	2,30	1,30	61,30	51,80	23,60	22,50	26,00	27,20	14,00	26,00	0,50	1,5x30°	0,5x30°	0,5x45°	16,30	0
12	44,00	34,40	2,30	1,30	73,20	63,60	25,80	28,00	31,00	32,70	16,00	33,00	0,50	1,5x30°	0,8x30°	0,5x45°	15,80	0
19	53,15	41,50	3,15	1,85	80,20	68,50	29,25	33,00	42,00	44,50	23,00	45,00	1,50	1,5x30°	1,0x30°	0,8x45°	20,30	0

Montaje del panel

DN mm	L1 mm	L2 mm	L3 mm	L4 mm	L5 mm	L6 mm	L7 mm	D1 mm	D2 mm	D3 mm	Rosca A	F1	F2	F3	B1	B2
3	5,00	11,00	13,70	6,70	11,00			9,80	11,2	11,2	G 1/16				17,90	12,90
4	15,00	9,80	17,20	5,50	15,35			13,80	16,2	16,2	G 1/8				20,50	12,70
6	15,00	13,15	23,00	5,50	33,20			18,30	21,2	21,2	G 1/4				25,00	13,50
9	15,00	12,80	29,60	5,30	38,80			22,30	25,2	25,2	G 3/8				29,80	13,50
12	15,00	22,90	31,80	5,30	50,60			27,80	30,2	32,2	G 1/2				29,40	12,30
19	15,00	32,00	35,40	4,40	57,60			32,80	41,2	44,2	G 3/4				33,85	12,30

Serie 21 - Seguridad

Diámetro nominal
5 = 20 mm²



Acoplamiento mini industrial con el perfil más popular del mundo en este diámetro nominal. Rendimiento de caudal superior a la media para medios líquidos y gaseosos. También utiliza un sistema de bloqueo de seguridad adicional. Esto evita una desconexión involuntaria. Al desconectarse, el enchufe debe ser empujado primero más adentro del acoplamiento antes de que pueda ser desconectado.

- Disponible a petición:
 - en material de latón sin niquelado
 - con conexiones finales adicionales
 - otras juntas para diferentes rangos de temperatura y fluidos

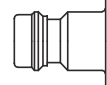

Protecciones contra el polvo (P. 357)
para acoplar la pieza-No. SK13



Simple obturación

Presión de trabajo*:
hasta 35 bar

Material:

- Enchufe: Latón niquelado
- Acoplador: Latón niquelado
- Junta: NBR

Temperatura de trabajo:
-20°C hasta +100°C (NBR)

Caudal de aire:

550 l/min.
presión de entrada 6 bar, caída de presión 0,5 bar

Caudal de agua:

7 l/min.
caída de presión de 0,5 bar



Doble obturación

Presión de trabajo*:
hasta 35 bar

Material:

- Enchufe: Latón niquelado
- Acoplador: Latón niquelado
- Junta: NBR

Temperatura de trabajo:
-20°C hasta +100°C (NBR)

Caudal de aire:

310 l/min.
presión de entrada 6 bar, caída de presión 0,5 bar

Caudal de agua:

2,7 l/min.
caída de presión de 0,5 bar

* máxima presión estática de trabajo con un factor de diseño de 4 a 1.



Simple obturación

21KSAW Enchufe con válvula, rosca macho

Latón niquelado, NBR

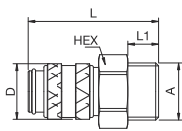

A	HEX	L	L1	D
G1/8	21KSAW10MPN	14	36	7 16
G1/4	21KSAW13MPN	17	38	9 16
G3/8	21KSAW17MPN	19	38	9 16



Simple obturación

21KSTF Enchufe con válvula, conexión manguera

Latón niquelado, NBR

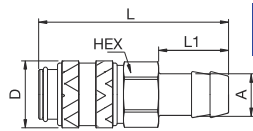

A	HEX	L	L1	D
4	21KSTF04MPN	14	46	17 16
5	21KSTF05MPN	14	46	17 16
6	21KSTF06MPN	14	46	17 16
8	21KSTF08MPN	14	46	17 16
9	21KSTF09MPN	14	46	17 16
10	21KSTF10MPN	14	46	17 16

21KSIW Enchufe con válvula, rosca hembra

Latón niquelado, NBR

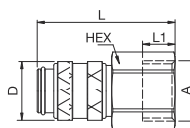

A	HEX	L	L1	D
G1/8	21KSIW10MPN	14	36	9 16
G1/4	21KSIW13MPN	17	38	9 16
G3/8	21KSIW17MPN	19	38	9 16

Serie 21 - Seguridad

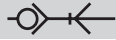

Simple obturación

21SSAW Acoplador sin válvula, rosca macho

Latón niquelado

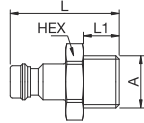

A	HEX	L	L1
G1/8	21SSAW10MXN	14	25 7
G1/4	21SSAW13MXN	17	28 9



Doble obturación

21KDAW Enchufe con válvula, rosca macho

Latón niquelado, NBR

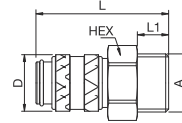

A	HEX	L	L1	D
G1/8	21KDAW10MPN	14	36 7 16	
G1/4	21KDAW13MPN	17	38 9 16	
G3/8	21KDAW17MPN	19	38 9 16	

21SSIW Acoplador sin válvula, rosca hembra

Latón niquelado

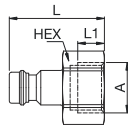
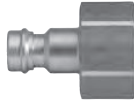

A	HEX	L	L1
G1/8	21SSIW10MXN	14	25 8
G1/4	21SSIW13MXN	17	25 9

21KDIW Enchufe con válvula, rosca hembra

Latón niquelado, NBR

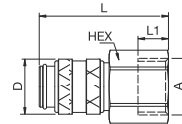

A	HEX	L	L1	D
G1/8	21KDIW10MPN	14	36 9 16	
G1/4	21KDIW13MPN	17	38 9 16	
G3/8	21KDIW17MPN	19	38 9 16	

21SSTF Acoplador sin válvula, conexión manguera

Latón niquelado

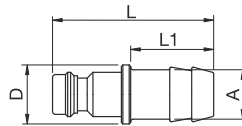

A	L	L1	D
6	21SSTF06MXN	32 17 9	
8	21SSTF08MXN	32 17 9	
10	21SSTF10MXN	33 17 12	

21KDTF Enchufe con válvula, conexión manguera

Latón niquelado, NBR

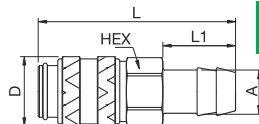

A	HEX	L	L1	D
6	21KDTF06MPN	14 46 17 16		
8	21KDTF08MPN	14 46 17 16		
10	21KDTF10MPN	14 46 17 16		

21SDAW Acoplador con válvula, rosca macho

Latón niquelado, NBR

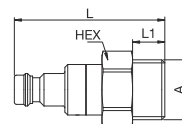

A	HEX	L	L1
G1/8	21SDAW10MPN	14 40 7	
G1/4	21SDAW13MPN	17 42 9	
G3/8	21SDAW17MPN	19 42 9	

Serie 21 - Seguridad

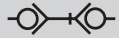

Doble obturación

21SDIW Acoplador con válvula, rosca hembra

Latón niquelado, NBR

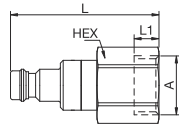
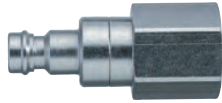

A		HEX	L	L1
G1/8	21SDIW10MPN	14	40	7
G1/4	21SDIW13MPN	17	42	7
G3/8	21SDIW17MPN	19	42	7

21SDTF Acoplador con válvula, conexión manguera

Latón niquelado, NBR

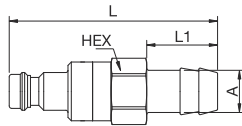

A		HEX	L	L1
6	21SDTF06MPN	14	50	17
8	21SDTF08MPN	14	50	17
10	21SDTF10MPN	14	50	17

Serie 25 - Seguridad

Diámetro nominal
7,8 = 48 mm²



Acoplamiento de seguridad con válvula UltraFlo para un caudal óptimo y una baja caída de presión. La serie destaca por su robusto diseño (manguito de acero) y su larga vida útil incluso con el uso más duro. Sistema de bloqueo de seguridad adicional. Este bloqueo de seguridad evita una desconexión involuntaria. Para desconectar, el enchufe debe ser empujado primero más adentro del acoplamiento antes de que pueda ser desbloqueado. La versión de latón ha sido desarrollada específicamente para el uso con agua en el rango de presión de hasta 35 bar.

- Disponible a petición:
 - en material de latón sin niquelado
 - con conexiones finales adicionales
 - otras juntas para diferentes rangos de temperatura y fluidos

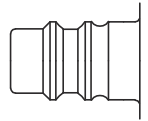

KS Simple obturación

Presión de trabajo*:
hasta 35 bar: latón niquelado / acero

Material:

- Enchufe: Latón / acero o latón
- Acoplador: Acero zincado o latón
- Junta: NBR

Temperatura de trabajo:
-20°C hasta +100°C (NBR)

Caudal de aire:
1.800 l/min.
presión de entrada 6 bar, caída de presión 0,5 bar

Caudal de agua:
28 l/min.
caída de presión de 0,5 bar

KD Doble obturación

Presión de trabajo*:
hasta 35 bar

Material:

- Enchufe: Latón niquelado
- Acoplador: Latón niquelado
- Junta: NBR

Temperatura de trabajo:
-20°C hasta +100°C (NBR)

Caudal de aire:
710 l/min.
presión de entrada 6 bar, caída de presión 0,5 bar

Caudal de agua:
7,1 l/min.
caída de presión de 0,5 bar

* máxima presión estática de trabajo con un factor de diseño de 4 a 1.

Simple obturación

25KSAK Enchufe con válvula, rosca macho

Latón/acero niquelado, NBR

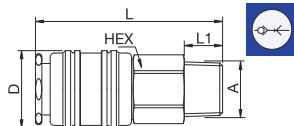

A	HEX	L	L1	D
R1/4	25KSAK13SPN	19	60	12 23
R3/8	25KSAK17SPN	19	60	12 23
R1/2	25KSAK21SPN	22	61	17 23

Simple obturación

25KSTF Enchufe con válvula, conexión manguera

Latón/acero niquelado, NBR

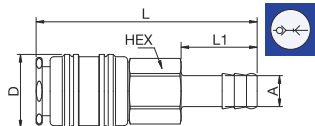

A	HEX	L	L1	D
6	25KSTF06SPN	19	74	25 23
8	25KSTF08SPN	19	74	25 23
9	25KSTF09SPN	19	74	25 23
10	25KSTF10SPN	19	74	25 23
13	25KSTF13SPN	19	74	25 23

25KSIW Enchufe con válvula, rosca hembra

Latón/acero niquelado, NBR

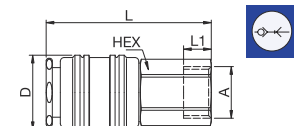

A	HEX	L	L1	D
G1/4	25KSIW13SPN	19	56	10 23
G3/8	25KSIW17SPN	19	55	9 23
G1/2	25KSIW21SPN	24	58	12 23

Serie 25 - Seguridad

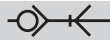

Simple obturación

25SSAK Acoplador sin válvula, rosca macho

Acero zincado

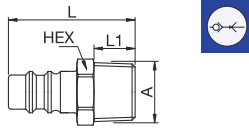

A	HEX	L	L1
R1/4 25SSAK13SXZ	14	37	12
R3/8 25SSAK17SXZ	17	37	12
R1/2 25SSAK21SXZ	22	43	17

25SSIW Acoplador sin válvula, rosca hembra

Acero zincado

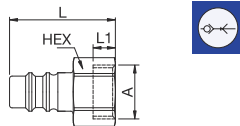

A	HEX	L	L1
G1/4 25SSIW13SXZ	17	33	9
G3/8 25SSIW17SXZ	19	33	9

25SSTF Acoplador sin válvula, conexión manguera

Acero zincado

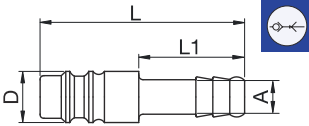

A	L	L1	D
9 25SSTF09SXZ	48	25	12



Doble obturación

25KDAK Enchufe con válvula, rosca macho

Latón niquelado, NBR

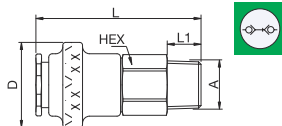
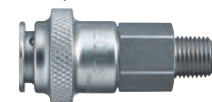

A	HEX	L	L1	D
R1/4 25KDAK13BPN	19	60	12	30
R3/8 25KDAK17BPN	19	60	12	30
R1/2 25KDAK21BPN	22	61	17	30

25KDIW Enchufe con válvula, rosca hembra

Latón niquelado, NBR

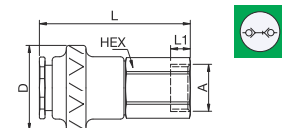
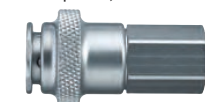

A	HEX	L	L1	D
G1/4 25KDIW13BPN	19	56	10	30
G3/8 25KDIW17BPN	19	55	9	30
G1/2 25KDIW21BPN	24	58	12	30

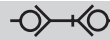

Doble obturación

25KDTF Enchufe con válvula, conexión manguera

Latón niquelado, NBR

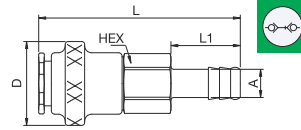

A	HEX	L	L1	D
6 25KDTF06BPN	19	74	25	30
8 25KDTF08BPN	19	74	25	30
9 25KDTF09BPN	19	74	25	30
10 25KDTF10BPN	19	74	25	30
13 25KDTF13BPN	19	74	25	30

25SDAW Acoplador con válvula, rosca macho

Latón niquelado, NBR

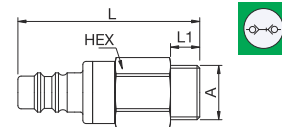

A	HEX	L	L1
G1/4 25SDAW13MPN	22	43	9
G3/8 25SDAW17MPN	22	43	9
G1/2 25SDAW21MPN	22	46	12

25SDIW Acoplador con válvula, rosca hembra

Latón niquelado, NBR

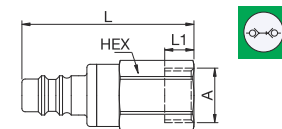

A	HEX	L	L1
G1/4 25SDIW13MPN	22	43	10
G3/8 25SDIW17MPN	22	43	9
G1/2 25SDIW21MPN	24	46	12

25SDTF Acoplador con válvula, conexión manguera

Latón niquelado, NBR

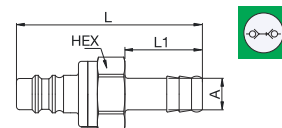

A	HEX	L	L1
6 25SDTF06MPN	21	60	25
8 25SDTF08MPN	21	60	25
9 25SDTF09MPN	21	60	25
10 25SDTF10MPN	21	60	25
13 25SDTF13MPN	21	60	25

Serie 95 - Aire respirable

Diámetro nominal
7,4 = 43 mm²



Este sistema de acoplamiento ha sido desarrollado específicamente para el área de los aparatos de respiración de aire. Sistema de acoplamiento con una sola mano. Válvula de alto caudal para un caudal óptimo y una baja caída de presión. Sistema de bloqueo de seguridad adicional. Este bloqueo de seguridad evita una desconexión involuntaria. Para desconectar, el enchufe debe ser empujado primero más adentro del acoplamiento antes de que pueda ser desbloqueado. El perfil no se puede interconectar con la serie 96KS. Comprobado según la norma DIN EN 14593.

- Disponible a petición:
 - con conexiones finales adicionales
 - otras juntas para diferentes rangos de temperatura y fluidos

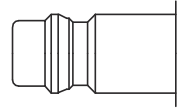

Protecciones contra el polvo (P. 357)
para acoplar la pieza-No. SK23S



Aire respirable

Presión de trabajo*:
hasta 35 bar

Material:

- Enchufe: Latón niquelado / AISI 303 o latón niquelado
- Acoplador: Latón niquelado
- Junta: NBR

Temperatura de trabajo:
-20°C hasta +100°C (NBR)

Caudal de aire:
1 700 l/min.
presión de entrada 6 bar, caída de presión 0,5 bar

* máxima presión estática de trabajo con un factor de diseño de 4 a 1.

Aire respirable

95KSAK Enchufe con válvula, rosca macho

Latón niquelado o acero inoxidable, NBR

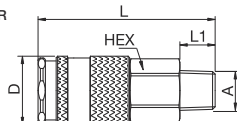



A		HEX	L	L1	D	Versión
R1/4	95KSAK13BPN	19	61	12	23	Latón niquelado
	95KSAK13RPN	19	61	12	23	Acero inoxidable
R3/8	95KSAK17BPN	19	60	12	23	Latón niquelado
	95KSAK17RPN	19	60	12	23	Acero inoxidable
R1/2	95KSAK21BPN	22	61	17	23	Latón niquelado
	95KSAK21RPN	22	61	17	23	Acero inoxidable

Aire respirable

95KSIW Enchufe con válvula, rosca hembra

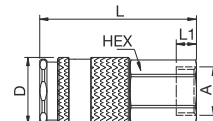
Latón niquelado o acero inoxidable, NBR



A		HEX	L	L1	D	Versión
R1/4	95KSIW13BPN	19	56	10	23	Latón niquelado
	95KSIW13RPN	19	56	10	23	Acero inoxidable
R3/8	95KSIW17BPN	19	55	9	23	Latón niquelado
	95KSIW17RPN	19	55	9	23	Acero inoxidable
R1/2	95KSIW21BPN	24	58	12	23	Latón niquelado
	95KSIW21RPN	24	58	12	23	Acero inoxidable

Serie 95 - Aire respirable



Aire respirable

95KSTF Enchufe con válvula, conexión manguera

Latón niquelado o acero inoxidable, NBR

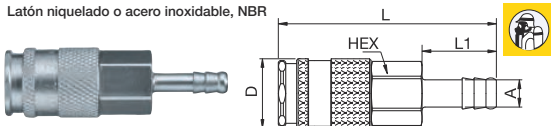

A		HEX	L	L1	D	Versión
6	95KSTF06BPN	19	74	25	23	Latón niquelado
8	95KSTF08BPN	19	74	25	23	Latón niquelado
9	95KSTF09BPN	19	74	25	23	Latón niquelado
	95KSTF09RPN	19	74	25	23	Acero inoxidable
10	95KSTF10BPN	19	74	25	23	Latón niquelado
	95KSTF10RPN	19	74	25	23	Acero inoxidable
13	95KSTF13BPN	19	74	25	23	Latón niquelado

95SSAK Acoplador sin válvula, rosca macho

Latón niquelado

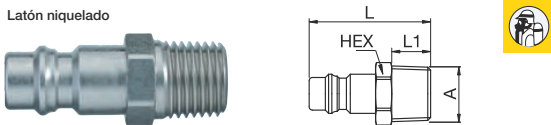

A		HEX	L	L1
R1/4	95SSAK13MXN	14	37,5	12
R3/8	95SSAK17MXN	17	37,5	12

95SSIW Acoplador sin válvula, rosca hembra

Latón niquelado

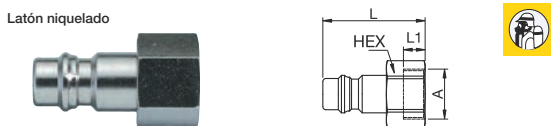

A		HEX	L	L1
G1/4	95SSIW13MXN	17	33	9
G3/8	95SSIW17MXN	19	33	9

95SSTF Acoplador sin válvula, conexión manguera

Latón niquelado

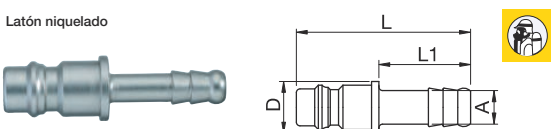

A		L	L1	D
6	95SSTF06MXN	47,5	25	14
9	95SSTF09MXN	47,5	25	14
10	95SSTF10MXN	47,5	25	14

Serie 96 - Aire respirable

Diámetro nominal
7,4 = 43 mm²

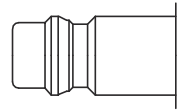

Este sistema de acoplamiento ha sido desarrollado específicamente para el área de los aparatos de respiración de aire. Sistema de acoplamiento con una sola mano. Válvula de alto caudal para un caudal óptimo y una baja caída de presión. Sistema de bloqueo de seguridad adicional. Este bloqueo de seguridad evita una desconexión involuntaria. Para desconectar, el enchufe debe ser empujado primero más adentro del acoplamiento antes de que pueda ser desbloqueado. Comprobado según la norma DIN EN 14593.

- Disponible a petición:
 - con conexiones finales adicionales
 - otras juntas para diferentes rangos de temperatura y fluidos

Protecciones contra el polvo (P. 357)
para acoplar la pieza-No. SK23S
para enchufe la pieza-No. SK12S



Presión de trabajo*:
hasta 35 bar

Material:

- Enchufe: Latón niquelado
- Acoplador: Latón niquelado o AISI 303
- Junta: NBR o FKM

Temperatura de trabajo:

-20°C hasta +100°C (NBR)

Caudal de aire:

1 700 l/min.

presión de entrada 6 bar, caída de presión 0,5 bar

* máxima presión estática de trabajo con un factor de diseño de 4 a 1.



Aire respirable

96KSAK Enchufe con válvula, rosca macho

Latón niquelado, NBR

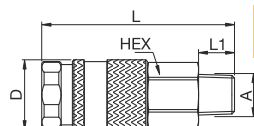
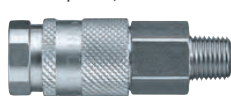

A		HEX	L	L1	D
R1/4	96KSAK13BPN	19	65	12	23
R3/8	96KSAK17BPN	19	64	12	23
R1/2	96KSAK21BPN	22	66	17	23



Aire respirable

96KSTF Enchufe con válvula, conexión manguera

Latón niquelado, NBR

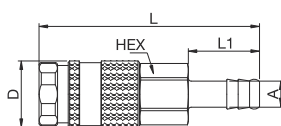
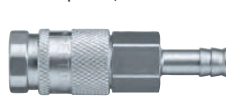

A		HEX	L	L1	D
6	96KSTF06BPN	19	78	25	23
9	96KSTF09BPN	19	78	25	23
10	96KSTF10BPN	19	78	25	23
13	96KSTF13BPN	19	78	25	23

96KSIW Enchufe con válvula, rosca hembra

Latón niquelado, NBR

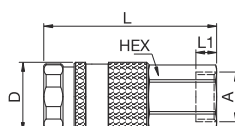

A		HEX	L	L1	D
G1/4	96KSIW13BPN	19	60	10	23
G3/8	96KSIW17BPN	19	59	9	23
G1/2	96KSIW21BPN	24	62	10	23

Serie 96



Aire respirable

96SSA Acoplador sin válvula, rosca macho

Latón niquelado o acero inoxidable

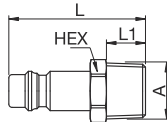

A		HEX	L	L1	Versión
R1/4	96SSAK13MXN	14	42	12	Latón niquelado
R3/8	96SSAK17MXN	17	42	12	Latón niquelado
G3/8	96SSAW17RXX	19	38	9	Acero inoxidable

96SSIW Acoplador sin válvula, rosca hembra

Latón niquelado

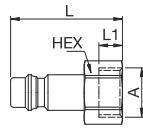

A		HEX	L	L1
G1/4	96SSIW13MXN	17	38	10
G3/8	96SSIW17MXN	19	38	10

96SSTF Acoplador sin válvula, conexión manguera

Latón niquelado

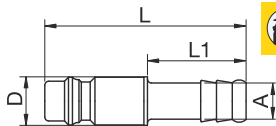

A		L	L1	D
6	96SSTF06MXN	51	25	12
9	96SSTF09MXN	51	25	12
10	96SSTF10MXN	54	25	14

Serie 18 - Tecnología de botón con descompresión

Diámetro nominal
5,5 = 25 mm²



Acoplamiento de seguridad con un sistema de descompresión para el perfil de enchufe ISO 6150 C. La descompresión tiene lugar durante la desconexión, no hay riesgo de que las mangueras presurizadas sean lanzadas. Cuando se presiona el botón pulsador por primera vez, el aire se libera del acoplamiento pero el enchufe del acoplamiento permanece bloqueado. El enchufe sólo se desconecta cuando se presiona el Pulsador por segunda vez. El sistema cumple con los requisitos de la norma ISO4414 - mayores estándares de seguridad en el lugar de trabajo. DIN EN 983. El cuerpo del acoplamiento gira 360°, por lo que el Pulsador es visible en cualquier posición.

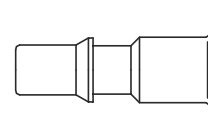

Perfil ISO 6150 C



Presión de trabajo*:

hasta 12 bar

Material:

- Enchufe: Aluminio anodizado, Latón niquelado
- Acoplador: Acero niquelado
- Junta: NBR

Temperatura de trabajo:

-20°C hasta +100°C (NBR)

Caudal de aire:

810 l/min.

presión de entrada 6 bar, caída de presión 0,5 bar

* máxima presión estática de trabajo con un factor de diseño de 4 a 1.



Sistema de purga automática

18KPAW Enchufe con válvula, rosca macho

Aluminio anodizado, latón niquelado

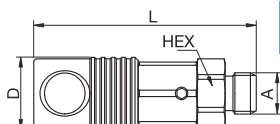

A		HEX	L	D
G1/4	18KPAW13APX	20	71,4	23
G3/8	18KPAW17APX	20	71,4	23
G1/2	18KPAW21APX	22	75,4	23



Sistema de purga automática

18KPTF Enchufe con válvula, conexión manguera

Aluminio anodizado, latón niquelado

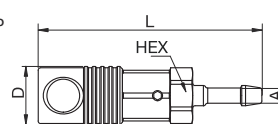

A		HEX	L	D
6	18KPTF06APX	20	88,9	23
8	18KPTF08APX	20	88,9	23
9	18KPTF09APX	20	88,9	23
13	18KPTF13APX	20	93,4	23

18KPIW Enchufe con válvula, rosca hembra

Aluminio anodizado, latón niquelado

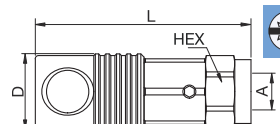

A		HEX	L	D
G1/4	18KPIW13APX	20	66,4	23
G3/8	18KPIW17APX	20	67,4	23
G1/2	18KPIW21APX	24	70,4	23

Serie 18 - Tecnología de botón con descompresión



Sistema de purga automática

18SAW Acoplador sin válvula, rosca macho

Acero niquelado

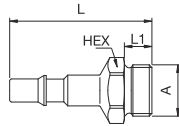

A			HEX	L	L1
G1/4	18SAW13SXN	9087 18 13	17	41	9
G3/8	18SAW17SXN	9087 18 17	19	41	9

18SFIW Acoplador sin válvula, rosca hembra

Acero niquelado

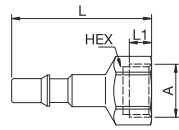

A			HEX	L	L1
G1/4	18SFIW13SXN	9086 18 13	17	43	9
G3/8	18SFIW17SXN	9086 18 17	19	44	9

18SFTF Acoplador sin válvula, conexión manguera

Acero niquelado

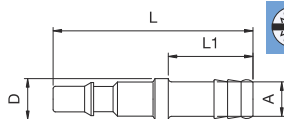

A			L	L1	D
6	18SFTF06SXN	9085 18 06	59	25	12
8	18SFTF08SXN	9085 18 08	59	25	12
10	18SFTF10SXN	9085 18 10	59	25	12
13	18SFTF13SXN	9085 18 13	59	25	12

Serie 24 - Tecnología de botón con descompresión

Diámetro nominal
5,5 = 25 mm²



Acoplamiento de seguridad con un sistema de descompresión para el perfil de enchufe ISO 6150 B. La descompresión tiene lugar durante la desconexión, no hay riesgo de que las mangueras presurizadas sean lanzadas. Cuando se presiona el botón pulsador por primera vez, el aire se libera del acoplamiento pero el enchufe del acoplamiento permanece bloqueado. El enchufe sólo se desconecta cuando se presiona el Pulsador por segunda vez. El sistema cumple con los requisitos de la norma ISO4414 - mayores estándares de seguridad en el lugar de trabajo. DIN EN 983. El cuerpo del acoplamiento gira 360°, por lo que el Pulsador es visible en cualquier posición.

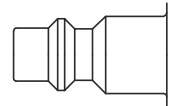

Perfil ISO 6150 B



Presión de trabajo*:
hasta 12 bar

Material:

- Enchufe: Aluminio anodizado, Latón niquelado
- Acoplador: Acero niquelado
- Junta: NBR

Temperatura de trabajo:
-20°C hasta +100°C (NBR)

Caudal de aire:

675 l/min.
presión de entrada 6 bar, caída de presión 0,5 bar

* máxima presión estática de trabajo con un factor de diseño de 4 a 1.



Sistema de purga automática

24KPAW Enchufe con válvula, rosca macho

Aluminio anodizado, latón niquelado

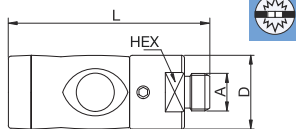

A		HEX	L	D
G1/4	24KPAW13APX	22	71,6	26
G3/8	24KPAW17APX	22	71,6	26
G1/2	24KPAW21APX	22	74,6	26



Sistema de purga automática

24KPTF Enchufe con válvula, conexión manguera

Aluminio anodizado, latón niquelado

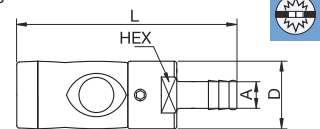

A		HEX	L	D
6	24KPTF06APX	22	85,4	26
8	24KPTF08APX	22	85,4	26
10	24KPTF10APX	22	85,4	26

24KPIW Enchufe con válvula, rosca hembra

Aluminio anodizado, latón niquelado

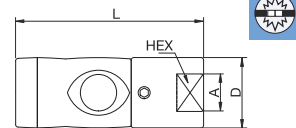

A		HEX	L	D
G1/4	24KPIW13APX	22	70,1	26
G3/8	24KPIW17APX	22	72,1	26
G1/2	24KPIW21APX	22	74,1	26

Serie 24 - Tecnología de botón con descompresión



Sistema de purga automática

23SFAK Acoplador sin válvula, rosca macho

Acero niquelado

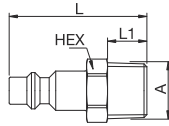
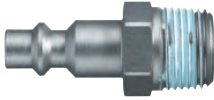

A		HEX	L	L1
R1/4	23SFAK13SXN	14	42	12
R3/8	23SFAK17SXN	17	42	12
R1/2	23SFAK21SXN	22	48	17

23SFIW Acoplador sin válvula, rosca hembra

Acero niquelado

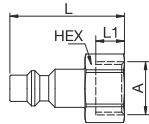

A		HEX	L	L1
G1/4	23SFIW13SXN	9086 23 13	17	36
G3/8	23SFIW17SXN	9086 23 17	19	36
G1/2	23SFIW21SXN	9086 23 21	24	39

23SFTF Acoplador sin válvula, conexión manguera

Acero niquelado

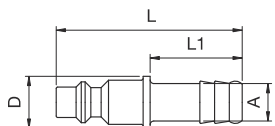

A		L	L1	D
6	23SFTF06SXN	9085 23 06	51	25
8	23SFTF08SXN	9085 23 08	51	25
10	23SFTF10SXN	9085 23 10	51	25

Serie 26 - Tecnología de botón con descompresión

Diámetro nominal
7,4 = 40 mm²



Acoplamiento de seguridad con un sistema de descompresión para el perfil de enchufe europeo. La descompresión tiene lugar durante la desconexión, no hay riesgo de que las mangueras presurizadas sean lanzadas. Cuando se presiona el botón pulsador por primera vez, el aire se libera del acoplamiento, pero el enchufe del acoplamiento permanece bloqueado. El enchufe sólo se desconecta cuando se presiona el Pulsador por segunda vez. El sistema cumple con los requisitos de la norma ISO4414 - mayores estándares de seguridad en el lugar de trabajo. DIN EN 983. El cuerpo del acoplamiento gira 360°, por lo que el Pulsador es visible en cualquier posición.

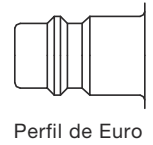

Presión de trabajo*:
hasta 12 bar

Material:

- Enchufe: Aluminio anodizado, Latón niquelado
- Acoplador: Acero zincado
- Junta: NBR

Temperatura de trabajo:
-20°C hasta +100°C (NBR)

Caudal de aire:
1 225 l/min.

presión de entrada 6 bar, caída de presión 0,5 bar

* máxima presión estática de trabajo con un factor de diseño de 4 a 1.



Sistema de purga automática

26KPAW Enchufe con válvula, rosca macho

Aluminio anodizado, latón niquelado

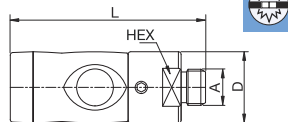

A		HEX	L	D
G1/4	26KPAW13APX	22	71,9	26
G3/8	26KPAW17APX	22	71,9	26
G1/2	26KPAW21APX	22	74,9	26



Sistema de purga automática

26KPTF Enchufe con válvula, conexión manguera

Aluminio anodizado, latón niquelado

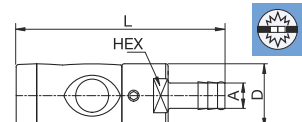

A		HEX	L	D
6	26KPTF06APX	22	85,7	26
8	26KPTF08APX	22	85,7	26
10	26KPTF10APX	22	85,7	26
13	26KPTF13APX	22	85,7	26

26KPIW Enchufe con válvula, rosca hembra

Aluminio anodizado, latón niquelado

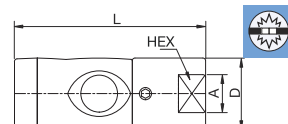

A		HEX	L	D
G1/4	26KPIW13APX	22	70,4	26
G3/8	26KPIW17APX	22	72,4	26
G1/2	26KPIW21APX	22	74,4	26

Serie 26 - Tecnología de botón con descompresión



Sistema de purga automática

25SFAK Acoplador sin válvula, rosca macho

Acero zincado

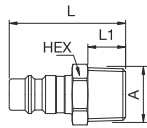

A		HEX	L	L1
R1/4	25SFAK13SXZ	14	37	12
R3/8	25SFAK17SXZ	17	37	12
R1/2	25SFAK21SXZ	22	43	17

25SFIW Acoplador sin válvula, rosca hembra

Acero zincado

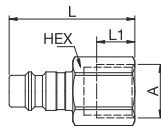

A			HEX	L	L1
G1/4	25SFIW13SXZ	9086 25 13	17	38,5	12
G3/8	25SFIW17SXZ	9086 25 17	19	39,5	12
G1/2	25SFIW21SXZ	9086 25 21	24	44	14

25SFTF Acoplador sin válvula, conexión manguera

Acero zincado

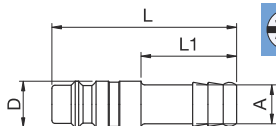

A			L	L1	D
6	25SFTF06SXZ	9085 25 06	48	25	12
8	25SFTF08SXZ	9085 25 08	48	25	12
10	25SFTF10SXZ	9085 25 10	48	25	12
13	25SFTF13SXZ	9085 25 13	48	25	15

Serie 30 - Tecnología de botón con descompresión

Diámetro nominal
8 = 60 mm²



Acoplamiento de seguridad con un sistema de descompresión para el perfil de enchufe ISO 6150 B. La descompresión tiene lugar durante la desconexión, no hay riesgo de que las mangueras presurizadas sean lanzadas. Cuando se presiona el botón pulsador por primera vez, el aire se libera del acoplamiento pero el enchufe del acoplamiento permanece bloqueado. El enchufe sólo se desconecta cuando se presiona el Pulsador por segunda vez. El sistema cumple con los requisitos de la norma ISO4414 - mayores estándares de seguridad en el lugar de trabajo. DIN EN 983. El cuerpo del acoplamiento gira 360°, por lo que el Pulsador es visible en cualquier posición.

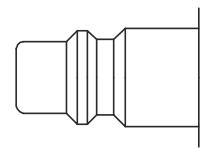

Perfil ISO 6150 B



Presión de trabajo*:
hasta 12 bar

Material:

- Enchufe: Aluminio anodizado, Latón niquelado
- Acoplador: Acero niquelado
- Junta: NBR

Temperatura de trabajo:
-20°C hasta +100°C (NBR)

Caudal de aire:
1 970 l/min.

presión de entrada 6 bar, caída de presión 0,5 bar

* máxima presión estática de trabajo con un factor de diseño de 4 a 1.



Sistema de purga automática

30KPAW Enchufe con válvula, rosca macho

Aluminio anodizado, latón niquelado

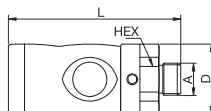

A	HEX	L	D
G1/4	30KPAW13APX	27	71,7 29
G3/8	30KPAW17APX	27	70,7 29
G1/2	30KPAW21APX	27	73,7 29



Sistema de purga automática

30KPTF Enchufe con válvula, conexión manguera

Aluminio anodizado, latón niquelado

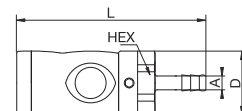

A	HEX	L	D
8	30KPTF08APX	27	86,7 29
10	30KPTF10APX	27	86,7 29

30KPIW Enchufe con válvula, rosca hembra

Aluminio anodizado, latón niquelado

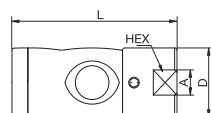

A	HEX	L	D
G1/4	30KPIW13APX	23	69,7 29
G3/8	30KPIW17APX	23	71,7 29
G1/2	30KPIW21APX	27	73,7 29

Serie 30 - Tecnología de botón con descompresión



Sistema de purga automática

30SFAW Acoplador sin válvula, rosca macho

Acero niquelado

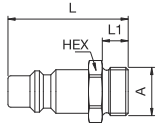

A			HEX	L	L1
G1/4	30SFAW13SXN	9087 30 13	17	42	9
G3/8	30SFAW17SXN	9087 30 17	19	42	9
G1/2	30SFAW21SXN	9087 30 21	24	46	12

30SFIW Acoplador sin válvula, rosca hembra

Acero niquelado

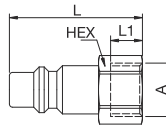

A			HEX	L	L1
G1/4	30SFIW13SXN	9086 30 13	17	40	10
G3/8	30SFIW17SXN	9086 30 17	19	42	10
G1/2	30SFIW21SXN	9086 30 21	24	43	12

30SFTF Acoplador sin válvula, conexión manguera

Acero niquelado

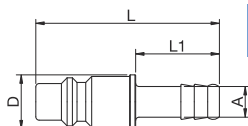

A			L	L1	D
8	30SFTF08SXN	9085 30 08	55	25	16
10	30SFTF10SXN	9085 30 10	55	25	16

Serie 84 - Tecnología de botón con descompresión

Diámetro nominal
8 = 50 mm²



Acoplamiento de seguridad con un sistema de descompresión para el perfil de enchufe ISO 6150 C. La descompresión tiene lugar durante la desconexión, no hay riesgo de que las mangueras presurizadas sean lanzadas. Cuando se presiona el botón pulsador por primera vez, el aire se libera del acoplamiento pero el enchufe del acoplamiento permanece bloqueado. El enchufe sólo se desconecta cuando se presiona el Pulsador por segunda vez. El sistema cumple con los requisitos de la norma ISO4414 - mayores estándares de seguridad en el lugar de trabajo. DIN EN 983. El cuerpo del acoplamiento gira 360°, por lo que el Pulsador es visible en cualquier posición.

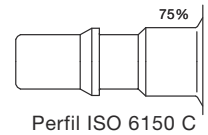

Presión de trabajo*:
hasta 12 bar

Material:

- Enchufe: Aluminio anodizado, Latón niquelado
- Acoplador: Acero niquelado
- Junta: NBR

Temperatura de trabajo:
-20°C hasta +100°C (NBR)

Caudal de aire:
2 100 l/min.

presión de entrada 6 bar, caída de presión 0,5 bar

* máxima presión estática de trabajo con un factor de diseño de 4 a 1.



Sistema de purga automática

84KPAW Enchufe con válvula, rosca macho

Aluminio anodizado, latón niquelado

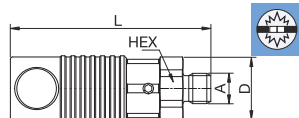

A		HEX	L	D
G1/4	84KPAW13APX	25	86,4	28
G3/8	84KPAW17APX	25	86,4	28
G1/2	84KPAW21APX	25	89,4	28



Sistema de purga automática

84KPTF Enchufe con válvula, conexión manguera

Aluminio anodizado, latón niquelado

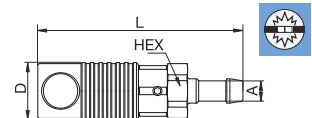

A		HEX	L	D
10	84KPTF10APX	25	101,9	28
13	84KPTF13APX	25	107,4	28

84KPIW Enchufe con válvula, rosca hembra

Aluminio anodizado, latón niquelado

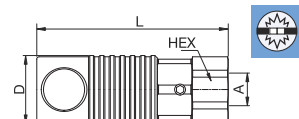
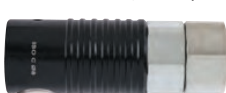

A		HEX	L	D
G1/4	84KPIW13APX	25	79,4	28
G3/8	84KPIW17APX	25	79,4	28
G1/2	84KPIW21APX	25	82,4	28

Serie 84 - Tecnología de botón con descompresión



Sistema de purga automática

84SFAW Acoplador sin válvula, rosca macho

Acero niquelado

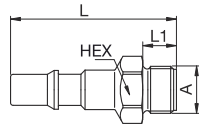

A		HEX	L	L1
G1/4	84SFAW13SXN	17	57	12
G3/8	84SFAW17SXN	21	59	12
G1/2	84SFAW21SXN	21	64	15

84SFIW Acoplador sin válvula, rosca hembra

Acero niquelado

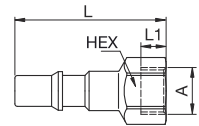

A		HEX	L	L1
G1/4	84SFIW13SXN	17	17	9
G3/8	84SFIW17SXN	19	19	9

84SFTF Acoplador sin válvula, conexión manguera

Acero niquelado

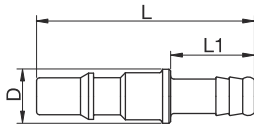

A		L	L1	D
10	84SFTF10SXN	65	25	16
13	84SFTF13SXN	65	25	18

Serie 14 - Tecnología de corredera con descompresión

Diámetro nominal
5,5 = 25 mm²



Acoplamiento de seguridad con un sistema de descompresión. La descompresión se produce durante la desconexión, sin riesgo de que las mangueras presurizadas sean lanzadas. Cuando la corredera se retira, el enchufe se libera pero permanece bloqueado. La válvula de acoplamiento se cierra y el aire se ventila de la línea de aire al mismo tiempo. Sólo entonces, operando la corredera de nuevo, puede tener lugar el desacoplamiento de forma segura. El sistema cumple con los requisitos de la norma ISO 4414: aumento de las normas de seguridad en el lugar de trabajo. La corredera de plástico no raya las superficies de trabajo.

- Disponible a petición:
 - con conexiones finales adicionales

Nota de seguridad

La fiabilidad de funcionamiento sólo puede garantizarse en conjunción con los enchufes Parker Rectus originales de acero.

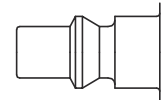

Perfil de ARO



Sistema de descompresión

Presión de trabajo*:

hasta 12 bar

Material:

- Enchufe: Latón niquelado
- Acoplador: Acero niquelado
- Junta: NBR

Temperatura de trabajo:

-20°C hasta +60°C (NBR)

Caudal de aire:

1 400 l/min.

presión de entrada 6 bar, caída de presión 0,5 bar

* máxima presión estática de trabajo con un factor de diseño de 4 a 1.



Sistema de purga automática

14KEAK Enchufe con válvula, rosca macho

Latón niquelado, NBR

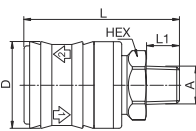
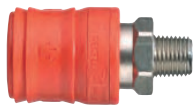

A		HEX	L	L1	D
R1/4	14KEAK13MPN	22	58	9	31
R3/8	14KEAK17MPN	22	58	9	31
R1/2	14KEAK21MPN	24	63	12	31



Sistema de purga automática

14KETF Enchufe con válvula, conexión manguera

Latón niquelado, NBR

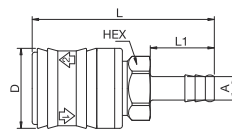
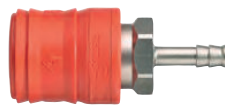

A		HEX	L	L1	D
6	14KETF06MPN	22	71	25	31
8	14KETF08MPN	22	71	25	31
9	14KETF09MPN	22	71	25	31
10	14KETF10MPN	22	71	25	31
13	14KETF13MPN	22	71	25	31

14KEIW Enchufe con válvula, rosca hembra

Latón niquelado, NBR

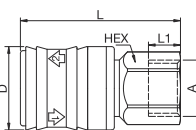

A		HEX	L	L1	D
G1/4	14KEIW13MPN	22	57	9	31
G3/8	14KEIW17MPN	22	57	9	31
G1/2	14KEIW21MPN	24	60	12	31

Serie 14 - Tecnología de corredera con descompresión



Sistema de purga automática

22SFAK Acoplador sin válvula, rosca macho

Acero niquelado

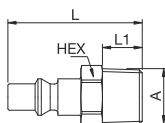

A			HEX	L	L1
R1/8	22SFAK10SXN		12	35	9
R1/4	22SFAK13SXN	9084 22 13	14	41	12
R3/8	22SFAK17SXN	9084 22 17	17	41	12
R1/2	22SFAK21SXN	9084 22 21	22	46	17

22SFIW Acoplador sin válvula, rosca hembra

Acero niquelado

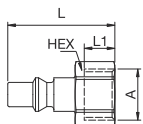

A			HEX	L	L1
G1/4	22SFIW13SXN	9086 22 13	17	35	9
G3/8	22SFIW17SXN	9086 22 17	19	35	10
G1/2	22SFIW21SXN	9086 22 21	24	35	12

22SFTF Acoplador sin válvula, conexión manguera

Acero niquelado

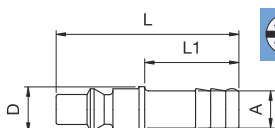

A			L	L1	D
6	22SFTF06SXN	9085 22 06	49	25	12
8	22SFTF08SXN	9085 22 08	49	25	12
9	22SFTF09SXN	9085 22 09	49	25	12
10	22SFTF10SXN	9085 22 10	49	25	12
13	22SFTF13SXN	9085 22 13	49	25	15

Serie 1400 - Tecnología de corredera con descompresión Diámetro nominal 5,5 = 25 mm²



Acoplamiento de seguridad 1/4" con un sistema de descompresión según la norma ISO 6150 B. La descompresión tiene lugar durante la desconexión - no hay riesgo de que las mangueras presurizadas sean lanzadas. Cuando la corredera se retira, el enchufe se libera pero permanece bloqueado. La válvula de acoplamiento se cierra y el aire se ventila de la línea de aire al mismo tiempo. Sólo entonces, operando la corredera de nuevo, puede tener lugar el desacoplamiento de forma segura. El sistema cumple con los requisitos de la norma ISO 4414: aumento de las normas de seguridad en el lugar de trabajo. DIN EN 983. Válvula de flujo ultra alto para un caudal óptimo y una baja caída de presión.

- Disponible a petición:

- con conexiones finales adicionales

Nota de seguridad

La fiabilidad de funcionamiento sólo puede garantizarse en conjunción con los enchufes Parker Rectus originales de acero.

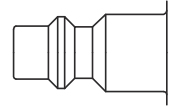

Perfil ISO 6150 B



Presión de trabajo*:
hasta 12 bar

Material:

- Enchufe: Latón / acero niquelado
- Acoplador: Acero niquelado
- Junta: NBR

Temperatura de trabajo:
-20°C hasta +100°C (NBR)

Caudal de aire:

950 l/min.

presión de entrada 6 bar, caída de presión 0,5 bar

* máxima presión estática de trabajo con un factor de diseño de 4 a 1.



Sistema de purga automática

1400KEAW Enchufe con válvula, rosca macho

Latón/acero niquelado, NBR

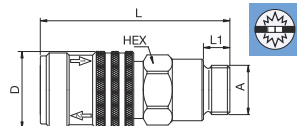

A	HEX	L	L1	D
G1/4	1400KEAW13SPN	19	64,5	9 26
G3/8	1400KEAW17SPN	21	64,5	9 26
G1/2	1400KEAW21SPN	24	67,5	12 26



Sistema de purga automática

1400KETF Enchufe con válvula, coexión manguera

Latón/acero niquelado, NBR

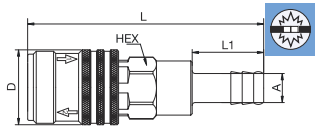

A	HEX	L	L1	D
6	1400KETF06SPN	19	82,5	25 26
8	1400KETF08SPN	19	82,5	25 26
10	1400KETF10SPN	19	82,5	25 26
13	1400KETF13SPN	19	82,5	25 26

1400KEIW Enchufe con válvula, rosca hembra

Latón/acero niquelado, NBR

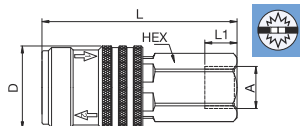

A	HEX	L	L1	D
G1/4	1400KEIW13SPN	19	61,5	9 26
G3/8	1400KEIW17SPN	19	61,5	9 26
G1/2	1400KEIW21SPN	24	64,5	12 26

Serie 1400 - Tecnología de corredera con descompresión



Sistema de purga automática

23SFAK Acoplador sin válvula, rosca macho

Acero niquelado

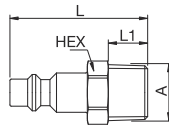
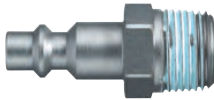

A		HEX	L	L1
R1/8	23SFAK10SXN	13	39	9
R1/4	23SFAK13SXN	14	42	12
R3/8	23SFAK17SXN	17	42	12
R1/2	23SFAK21SXN	22	48	17

23SFIW Acoplador sin válvula, rosca hembra

Acero niquelado

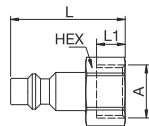

A		HEX	L	L1
G1/8	23SFIW10SXN	9086 23 10	14	36
G1/4	23SFIW13SXN	9086 23 13	17	36
G3/8	23SFIW17SXN	9086 23 17	19	36
G1/2	23SFIW21SXN	9086 23 21	24	39

23SFTF Acoplador sin válvula, conexión manguera

Acero niquelado

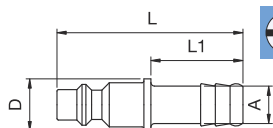

A		L	L1	D
6	23SFTF06SXN	9085 23 06	51	25
8	23SFTF08SXN	9085 23 08	51	25
9	23SFTF09SXN		51	25
10	23SFTF10SXN	9085 23 10	51	25
13	23SFTF13SXN		51	25

Serie 24 - Tecnología de corredera con descompresión

Diámetro nominal
5,5 = 25 mm²



Acoplamiento de seguridad de 1/4" con un sistema de descompresión según la norma ISO 6150 B. La descompresión tiene lugar durante la desconexión - no hay riesgo de que las mangueras presurizadas sean lanzadas. Cuando se tira la corredera hacia atrás, el enchufe es liberado, pero permanece encerrado. La válvula de acoplamiento se cierra y el aire se ventila desde la línea de aire al mismo tiempo. Sólo entonces, operando la corredera de nuevo, puede tener lugar el desacoplamiento de forma segura. El sistema cumple con los requisitos de la norma ISO 4414: aumento de las normas de seguridad en el lugar de trabajo. La corredera de plástico no raya las superficies de trabajo.

- Disponible a petición:
 - con conexiones finales adicionales

Nota de seguridad

La fiabilidad de funcionamiento sólo puede garantizarse en conjunción con los enchufes Parker Rectus originales de acero.

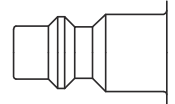

Perfil ISO 6150 B



Presión de trabajo*:
hasta 12 bar

Material:

- Enchufe: Latón niquelado
- Acoplador: Acero niquelado
- Junta: NBR

Temperatura de trabajo:
-20°C hasta +60°C (NBR)

Caudal de aire:

830 l/min.

presión de entrada 6 bar, caída de presión 0,5 bar

* máxima presión estática de trabajo con un factor de diseño de 4 a 1.



Sistema de purga automática

24KEAK Enchufe con válvula, rosca macho

Latón niquelado, NBR

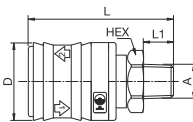

A	HEX	L	L1	D
R1/4 24KEAK13MPN	22	58	9	31
R3/8 24KEAK17MPN	22	58	9	31
R1/2 24KEAK21MPN	24	63	12	31



Sistema de purga automática

24KETF Enchufe con válvula, conexión manguera

Latón niquelado, NBR

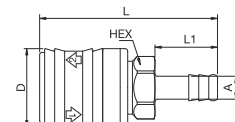

A	HEX	L	L1	D
6 24KETF06MPN	22	71	25	31
8 24KETF08MPN	22	71	25	31
9 24KETF09MPN	22	71	25	31
10 24KETF10MPN	22	71	25	31
13 24KETF13MPN	22	71	25	31

24KEIW Enchufe con válvula, rosca hembra

Latón niquelado, NBR

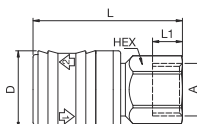

A	HEX	L	L1	D
G1/4 24KEIW13MPN	22	57	9	31
G3/8 24KEIW17MPN	22	57	9	31
G1/2 24KEIW21MPN	24	60	12	31

Serie 24 - Tecnología de corredera con descompresión



Sistema de purga automática

23SFAK Acoplador sin válvula, macho

Acero niquelado

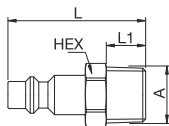

A		HEX	L	L1
R1/8	23SFAK10SXN	13	39	9
R1/4	23SFAK13SXN	14	42	12
R3/8	23SFAK17SXN	17	42	12
R1/2	23SFAK21SXN	22	48	17

23SFIW Acoplador sin válvula, macho

Acero niquelado

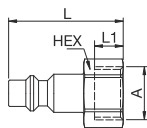

A		HEX	L	L1
G1/8	23SFIW10SXN	9086 23 10	14	36
G1/4	23SFIW13SXN	9086 23 13	17	36
G3/8	23SFIW17SXN	9086 23 17	19	36
G1/2	23SFIW21SXN	9086 23 21	24	39

23SFTF Acoplador sin válvula, conexión manguera

Acero niquelado

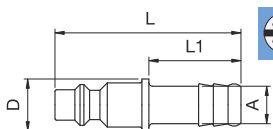

A		L	L1	D
6	23SFTF06SXN	9085 23 06	51	25
8	23SFTF08SXN	9085 23 08	51	25
9	23SFTF09SXN		51	25
10	23SFTF10SXN	9085 23 10	51	25
13	23SFTF13SXN		51	25

Serie 26 - Tecnología de corredera con descompresión

Diámetro nominal
7,4 = 25 mm²



Acoplamiento de seguridad con un sistema de descompresión para acoplador perfil de Euro. La descompresión tiene lugar durante la desconexión - no hay riesgo de que las mangueras presurizadas sean lanzadas. Cuando la corredera se retira, el enchufe se libera pero permanece bloqueado. La válvula de enchufe automático se cierra y el aire se ventila de la línea de aire al mismo tiempo. Sólo entonces, operando la corredera de nuevo, puede tener lugar el desacoplamiento de forma segura. El sistema cumple con los requisitos de la norma ISO 4414: aumento de las normas de seguridad en el lugar de trabajo. La corredera de plástico no raya las superficies de trabajo.

- Disponible a petición:
 - con conexiones finales adicionales

Nota de seguridad

La fiabilidad de funcionamiento sólo puede garantizarse en conjunción con los enchufes Parker Rectus originales de acero.

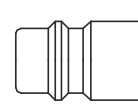

Perfil de Euro



Presión de trabajo*:

hasta 12 bar

Material:

- Enchufe: Latón niquelado
- Acoplador: Acero niquelado
- Junta: NBR

Temperatura de trabajo:

-20°C hasta +60°C (NBR)

Caudal de aire:

830 l/min.

presión de entrada 6 bar, caída de presión 0,5 bar

* máxima presión estática de trabajo con un factor de diseño de 4 a 1.



Sistema de purga automática

26KEAW Enchufe con válvula, rosca macho

Latón niquelado, NBR

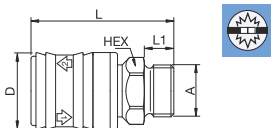

A	HEX	L	L1	D
G1/4 26KEAW13MPN	22	55	9	31
G3/8 26KEAW17MPN	22	55	9	31
G1/2 26KEAW21MPN	24	58	12	31



Sistema de purga automática

26KETF Enchufe con válvula, conexión manguera

Latón niquelado, NBR

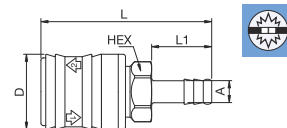
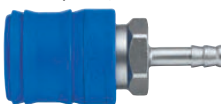

A	HEX	L	L1	D
6 26KETF06MPN	22	71	25	31
8 26KETF08MPN	22	71	25	31
9 26KETF09MPN	22	71	25	31
10 26KETF10MPN	22	71	25	31
13 26KETF13MPN	22	71	25	31

26KEIW Enchufe con válvula, rosca hembra

Latón niquelado, NBR

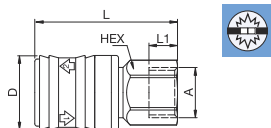

A	HEX	L	L1	D
G1/4 26KEIW13MPN	22	57	9	31
G3/8 26KEIW17MPN	22	57	9	31
G1/2 26KEIW21MPN	24	60	12	31

Serie 26 - Tecnología de corredera con descompresión



Sistema de purga automática

25SFAK Acoplador sin válvula, rosca macho

Acero zincado

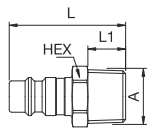

A		HEX	L	L1
R1/8	25SFAK10SXZ	13	33	9
R1/4	25SFAK13SXZ	14	37	12
R3/8	25SFAK17SXZ	17	37	12
R1/2	25SFAK21SXZ	22	43	17

25SFIW Acoplador sin válvula, rosca hembra

Acero zincado

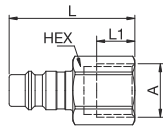

A		HEX	L	L1
G1/8	25SFIW10SXZ	9086 25 10	14	30
G1/4	25SFIW13SXZ	9086 25 13	17	38,5
G3/8	25SFIW17SXZ	9086 25 17	19	39,5
G1/2	25SFIW21SXZ	9086 25 21	24	44

25SFTF Acoplador sin válvula, conexión manguera

Acero zincado

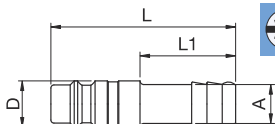

A		L	L1	D
6	25SFTF06SXZ	9085 25 06	48	25
8	25SFTF08SXZ	9085 25 08	48	25
9	25SFTF09SXZ	9085 25 09	48	25
10	25SFTF10SXZ	9085 25 10	48	25
13	25SFTF13SXZ	9085 25 13	48	25

Serie 1600 - Tecnología de corredera con descompresión Diámetro nominal 7,8 = 48 mm²



Enchufe automático de seguridad con un sistema de descompresión. La descompresión se produce durante la desconexión, sin riesgo de que las mangueras presurizadas sean lanzadas. Cuando la corredera se retira, el enchufe se libera pero permanece bloqueado. La válvula de enchufe automático se cierra y el aire se ventila de la línea de aire al mismo tiempo. Sólo entonces, operando la corredera de nuevo, puede tener lugar el desacoplamiento de forma segura. El sistema cumple con los requisitos de la norma ISO 4414: aumento de las normas de seguridad en el lugar de trabajo. DIN EN 983. Válvula de caudal ultra alto para un flujo óptimo y una baja caída de presión.

- Disponible a petición:

- con conexiones finales adicionales

Nota de seguridad

La fiabilidad de funcionamiento sólo puede garantizarse en conjunción con los enchufes Parker Rectus originales de acero.

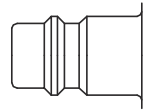

Perfil de Euro



Presión de trabajo*:
hasta 12 bar

Material:

- Enchufe: Latón / acero niquelado
- Acoplador: Acero zincado
- Junta: NBR

Temperatura de trabajo:
-20°C hasta +100°C (NBR)

Caudal de aire:
2 020 l/min.

presión de entrada 6 bar, caída de presión 0,5 bar

* máxima presión estática de trabajo con un factor de diseño de 4 a 1.



Sistema de purga automática

1600KEAK Enchufe con válvula, rosca macho

Latón/acero niquelado, NBR

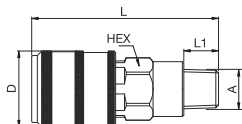

A		HEX	L	L1	D
R1/4	1600KEAK13SPN	19	64,5	12	26
R3/8	1600KEAK17SPN	19	64,5	12	26
R1/2	1600KEAK21SPN	22	59	17	26



Sistema de purga automática

1600KETF Enchufe con válvula, conexión manguera

Latón/acero niquelado, NBR

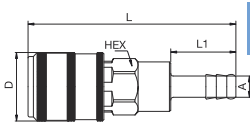

A		HEX	L	L1	D
6	1600KETF06SPN	19	79,5	25	26
8	1600KETF08SPN	19	79,5	25	26
9	1600KETF09SPN	19	79,5	25	26
10	1600KETF10SPN	19	79,5	25	26
13	1600KETF13SPN	19	79,5	25	26

1600KEIW Enchufe con válvula, rosca hembra

Latón/acero niquelado, NBR

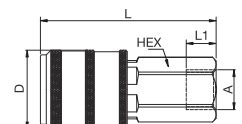

A		HEX	L	L1	D
G1/4	1600KEIW13SPN	19	59	10	26
G3/8	1600KEIW17SPN	19	59	9	26
G1/2	1600KEIW21SPN	24	61,5	12	26

Serie 1600 - Tecnología de corredera con descompresión



Sistema de purga automática

25SFAK Acoplador sin válvula, rosca macho

Acero zincado

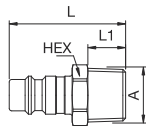

A		HEX	L	L1
R1/8	25SFAK10SXZ	13	33	9
R1/4	25SFAK13SXZ	14	37	12
R3/8	25SFAK17SXZ	17	37	12
R1/2	25SFAK21SXZ	22	43	17

25SFIW Acoplador sin válvula, rosca hembra

Acero zincado

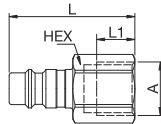

A		HEX	L	L1
G1/8	25SFIW10SXZ	9086 25 10	14	30
G1/4	25SFIW13SXZ	9086 25 13	17	38,5
G3/8	25SFIW17SXZ	9086 25 17	19	39,5
G1/2	25SFIW21SXZ	9086 25 21	24	44

25SFTF Acoplador sin válvula, conexión manguera

Acero zincado

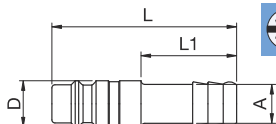

A		L	L1	D
6	25SFTF06SXZ	9085 25 06	48	25
8	25SFTF08SXZ	9085 25 08	48	25
9	25SFTF09SXZ	9085 25 09	48	25
10	25SFTF10SXZ	9085 25 10	48	25
13	25SFTF13SXZ	9085 25 13	48	25

Serie 1700 - Tecnología de corredera con descompresión

Diámetro nominal
10 = 80 mm²



Enchufe automático de seguridad con un sistema de descompresión. La descompresión se produce durante la desconexión, sin riesgo de que las mangueras presurizadas sean lanzadas. Cuando la corredera se retira, el enchufe se libera pero permanece bloqueado. La válvula de enchufe automático se cierra y el aire se ventila de la línea de aire al mismo tiempo. Sólo entonces, operando la corredera de nuevo, puede tener lugar el desacoplamiento de forma segura. El sistema cumple con la los requisitos de la ISO 4414 - mayores normas de seguridad en el lugar de trabajo. DIN EN 983. Válvula de caudal ultra alto para un flujo óptimo y una baja caída de presión.

- Disponible a petición:
 - con conexiones finales adicionales

Nota de seguridad

La fiabilidad de funcionamiento sólo puede garantizarse en conjunción con los enchufes Parker Rectus originales de acero.

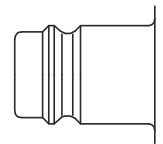

Perfil de Euro



Presión de trabajo*:
hasta 12 bar

Material:

- Enchufe: Latón / acero niquelado
- Acoplador: Acero niquelado
- Junta: NBR

Temperatura de trabajo:
-20°C hasta +100°C (NBR)

Caudal de aire:
3 500 l/min.

presión de entrada 6 bar, caída de presión 0,5 bar

* máxima presión estática de trabajo con un factor de diseño de 4 a 1.



Sistema de purga automática

1700KEAW Enchufe con válvula, rosca macho

Latón/acero niquelado, NBR

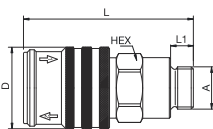

A	HEX	L	L1	D
G3/8 1700KEAW17SPN	24	67	9	32
G1/2 1700KEAW21SPN	24	70	12	32
G3/4 1700KEAW26SPN	30	74	16	32



Sistema de purga automática

27SFAK Acoplador sin válvula, rosca macho

Acero niquelado

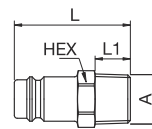

A	HEX	L	L1
R1/4 27SFAK13SXN	17	40	12
R3/8 27SFAK17SXN	17	40	12
R1/2 27SFAK21SXN	22	45	17
R3/4 27SFAK26SXN	27	48	19

1700KEIW Enchufe con válvula, rosca hembra

Latón/acero niquelado, NBR

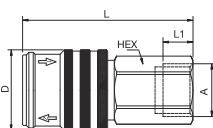

A	HEX	L	L1	D
G3/8 1700KEIW17SPN	24	64,5	12	32
G1/2 1700KEIW21SPN	24	68	12	32
G3/4 1700KEIW26SPN	32	74	16	32

27SFIW Acoplador sin válvula, rosca hembra

Acero niquelado

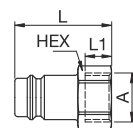

A	HEX	L	L1
G1/4 27SFIW13SXN	17	33	9
G3/8 27SFIW17SXN	9086 27 17	19	33
G1/2 27SFIW21SXN	9086 27 21	24	37
G3/4 27SFIW26SXN	9086 27 27	32	42

Serie 1700 - Tecnología de corredera con descompresión







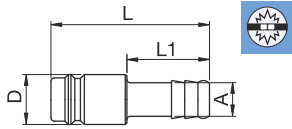

Sistema de purga automática

27SFTF Acoplador sin válvula, conexión manguera

Acero niquelado



A			L	L1	D
6			48	25	15
8		9085 27 08	48	25	15
9			48	25	15
10		9085 27 10	48	25	15
13		9085 27 13	48	25	15
16			49	25	18
19		9085 27 19	49	25	21

Serie C9000 - Tecnología de corredera de giro con descompresión

Diámetro nominal
7,2 = 25 mm²



La gama de acopladores poliméricos ergonómicos ha sido diseñada para la seguridad de los operarios y la maquinaria, mientras que se da un rendimiento muy alto de eficiencia energética. Disponible en tres estándares de perfil, se adapta perfectamente a cualquier tipo de instalación.

Nota de seguridad

Previene el riesgo del latigazo y la descompresión rápida permite llevar a cabo la desconexión con total seguridad.

ARO 5,5

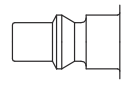

EURO 7,2

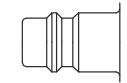

ISO B 5,5

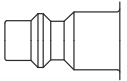

ISO B 8,0

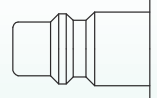

Presión de trabajo*:

hasta 16 bar

Material:

- Enchufe: Polímero técnico o aluminio, latón niquelado, acero inoxidable

- Acoplador: Acero niquelado

- Junta: NBR

Temperatura de trabajo:

-20°C hasta +60°C (NBR)

Caudal de aire:

- ARO 5,5: 1 250 l/min.

- Euro 7,2: 2 000 l/min.

- ISO B 5,5: 1 250 l/min.

- ISO B 8,0: 2 400 l/min.

presión de entrada 6 bar, caída de presión 0,5 bar

* máxima presión estática de trabajo con un factor de diseño de 4 a 1.



Sistema de purga automática

9401A Enchufe con válvula, rosca macho BSPP

Polímero técnico, latón niquelado, NBR

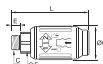

DN	C	E	F	G	L
5,5	G1/4 9401A06 13	6,5	17	31,5	70,5
	G3/8 9401A06 17	9	21	31,5	73,5
	G1/2 9401A06 21	9	25	31,5	70,5

Serie C9000: simple obturación = 1250 NI/min



Sistema de purga automática

9414A Enchufe con válvula, rosca hembra BSPP

Polímero técnico, latón niquelado, NBR

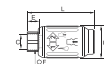

DN	C	E	F	G	L
5,5	G1/4 9414A06 13	12	17	31,5	64,5
	G3/8 9414A06 17	12	22	31,5	70
	G1/2 9414A06 21	15	27	31,5	76

Serie C9000: simple obturación = 1250 NI/min

9405A Enchufe con válvula, rosca macho BSPP

Polímero técnico, latón niquelado, NBR

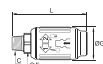

DN	C	F	G	L
5,5	R1/4 9405A06 13	17	31,5	73
	R3/8 9405A06 17	19	31,5	74,5
	R1/2 9405A06 21	22	31,5	79,5

Serie C9000: simple obturación = 1250 NI/min

9410A Acoplador con válvula, conexión enchufable LF 3000®, muelle de protección espiral

Polímero técnico, latón niquelado, NBR



DN	ØD	G	L	L1
5,5	8 9410A06 08	31,5	143	54
	10 9410A06 10	31,5	143	54

Serie C9000: simple obturación = 1250 NI/min

Serie C9000 - Tecnología de corredera de giro con descompresión



Sistema de purga automática

9421A Enchufe con válvula, con espiga acanalada para manguera

Polímero técnico, latón niquelado, NBR



DN	ØD		F	G	L	L1
6		9421A06 06	17	31,5	86,5	26
5,5		9421A06 08	17	31,5	86,5	26
10		9421A06 10	17	31,5	86,5	26

Serie C9000: simple obturación = 1250 NI/min

9416A Enchufe con válvula, montaje en pasamuros, rosca hembra BSPP

Polímero técnico, latón niquelado, NBR

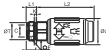

DN	C		E	F	G	K	L1	L2	ØT
5,5	G1/4	9416A06 13	12	22	31,5	6	12,5	66,5	18,5

Serie C9000: simple obturación = 1250 NI/min

9440A Enchufe Y, rosca hembra BSPP

Polímero técnico, latón niquelado, NBR

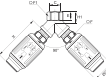

DN	C		E	F	F1	G	H	H1
5,5	G3/8	9440A06 17	11,5	19	20	31,5	68	16

Serie C9000: simple obturación = 1250 NI/min

9087A Acoplador sin válvula, rosca macho BSPP

Acero niquelado, polímero técnico

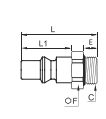

DN	C		E	F	L	L1
G1/4		9087A06 13	9	17	36	22
5,5	G3/8	9087A06 17	9	19	36	22
G1/2		9087A06 21	12	24	40	22

Sin obturación



Sistema de purga automática

9080A Acoplador sin válvula, conexión enchufable LF 3000®, con muelle de protección en espiral

Acero niquelado, NBR

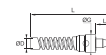

DN	ØD		G	L	L1
5,5	8	9080A06 08	24	118	22
	10	9080A06 10	24	118	22

Sin obturación

9094A Acoplador sin válvula, con espiga acanalada para manguera

Acero niquelado

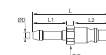

DN	ØD		F	L	L1	L2
6		9094A06 06	14	48,5	22	25
5,5	8	9094A06 08	14	48,5	22	25
	10	9094A06 10	14	48,5	22	25

Sin obturación

9401E Enchufe con válvula, rosca macho BSPP

Polímero técnico, latón niquelado, NBR

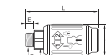

DN	C		E	F	G	L
G1/4		9401E07 13	6,5	22	36,5	80
7,2	G3/8	9401E07 17	7,5	22	36,5	81
	G1/2	9401E07 21	9	25	36,5	83,5

Serie C9000: simple obturación = 2000 NI/min

9414E Enchufe con válvula, rosca macho BSPP

Polímero técnico, latón niquelado, NBR



DN	C		E	F	G	L
G1/4		9414E07 13	12	22	36,5	73
7,2	G3/8	9414E07 17	12	22	36,5	73
	G1/2	9414E07 21	15	27	36,5	78

Serie C9000: simple obturación = 2000 NI/min

Serie C 9000 - Tecnología de corredera de giro con descompresión



Sistema de purga automática

9410E Enchufe con válvula, conexión enchufable LF 3000®, resorte de protección espiral

Polímero técnico, latón niquelado, NBR



DN	ØD		G	L	L1
7,2	10	9410E07 10	36,5	151	63
	12	9410E07 12	36,5	151	63

Serie C9000: simple obturación = 2000 NI/min



Sistema de purga automática

9087E Acoplador sin válvula, rosca macho BSPP

Acero niquelado, polímero técnico



DN	C		E	F	L	L1
7,2	G1/4	9087E07 13	9	14	34	20
	G3/8	9087E07 17	9	17	34	20
	G1/2	9087E07 21	12	22	38	20

Sin obturación

9421E Enchufe con válvula, con espiga acanalada para manguera

Polímero técnico, latón niquelado, NBR

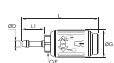

DN	ØD		F	G	L	L1
7,2	8	9421E07 08	22	36,5	93	26
	10	9421E07 10	22	36,5	93	26
	13	9421E07 13	22	36,5	97	30

Serie C9000: simple obturación = 2000 NI/min

9080E Acoplador sin válvula, conexión LF 3000®, con muelle de protección en espiral

Acero niquelado, NBR

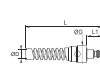

DN	ØD		G	L	L1
7,2	10	9080E07 10	24	114	20
	12	9080E07 12	29,5	125	20

Sin obturación

9416E Enchufe con válvula, montaje en pasamuros, rosca hembra BSPP

Polímero técnico, latón niquelado, NBR

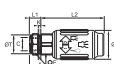

DN	C		E	F	G	K max	L1	L2	ØT min
7,2	G3/8	9416E07 17	12	24	36,5	7	14,5	74	22,5

Serie C9000: simple obturación = 2000 NI/min

9094E Acoplador sin válvula, con espiga acanalada para manguera

Acero niquelado

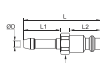

DN	ØD		F	L	L1	L2
7,2	8	9094E07 08	17	48	20	25
	10	9094E07 10	17	48	20	25
	13	9094E07 13	17	48	20	25

Sin obturación

9440E Enchufe Y, rosca hembra BSPP

Polímero técnico, latón niquelado, NBR

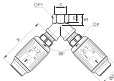

DN	C		E	F	F1	G	H	H1
7,2	G1/2	9440E07 21	14	25	25	36,5	78	19

Serie C9000: simple obturación = 2000 NI/min

9401U Enchufe con válvula, rosca macho BSPP

Polímero técnico, latón niquelado, NBR

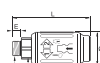

DN	C		E	F	G	L
5,5	G1/4	9401U06 13	7,5	17	31,5	74
	G3/8	9401U06 17	8,5	21	31,5	76,5
	G1/2	9401U06 21	10,5	25	31,5	80
8	G1/4	9401U08 13	6,5	22	36,5	81,5
	G3/8	9401U08 17	7,5	22	36,5	82,5
	G1/2	9401U08 21	9	25	36,5	85,5

Serie C9000 ISO B6: simple obturación = 1250 NI/min
Serie C9000 ISO B8: simple obturación = 2400 NI/min

Serie C9000 - Tecnología de corredera de giro con descompresión



Sistema de purga automática

9405U Enchufe con válvula, rosca macho BSPT

Polímero técnico, latón niquelado, NBR

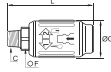

DN	C	F	G	L
5,5	R1/4 9405U06 13	17	31,5	75
	R3/8 9405U06 17	19	31,5	76,5
	R1/2 9405U06 21	22	31,5	81,5
8	R1/4 9405U08 13	22	36,5	84
	R3/8 9405U08 17	22	36,5	84
	R1/2 9405U08 21	22	36,5	88

Serie C9000 ISO B6: simple obturación = 1250 NI/min
Serie C9000 ISO B8: simple obturación = 2400 NI/min



Sistema de purga automática

9421U Enchufe con válvula, con espiga acanalada para manguera

Polímero técnico, latón niquelado, NBR

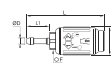

DN	ØD	F	G	L	L1
5,5	6 9421U06 06	17	31,5	88,5	26
	8 9421U06 08	17	31,5	88,5	26
	10 9421U06 10	17	31,5	88,5	26
8	6 9421U08 06	22	36,5	95	26
	8 9421U08 08	22	36,5	95	26
	10 9421U08 10	22	36,5	95	26
	13 9421U08 13	22	36,5	99	30

Serie C9000 ISO B6: simple obturación = 1250 NI/min
Serie C9000 ISO B8: simple obturación = 2400 NI/min

9414U Enchufe con válvula, rosca hembra BSPP

Polímero técnico, latón niquelado, NBR

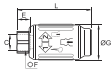

DN	C	E	F	G	L
5,5	G1/4 9414U06 13	12	17	31,5	66,5
	G3/8 9414U06 17	12	22	31,5	72
	G1/2 9414U06 21	15	27	31,5	78
8	G1/4 9414U08 13	12	22	36,5	75
	G3/8 9414U08 17	12	22	36,5	75
	G1/2 9414U08 21	15	27	36,5	80

Serie C9000 ISO B6: simple obturación = 1250 NI/min
Serie C9000 ISO B8: simple obturación = 2400 NI/min

9416U Enchufe con válvula, Montable en pasamuros, rosca hembra BSPP

Polímero técnico, latón niquelado, NBR

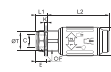

DN	C	E	F	G	K max	L1	L2	ØT min
5,5	G1/4 9416U06 13	12	22	31,5	6,0	12,5	68,5	18,5
8	G3/8 9416U08 17	12	24	36,5	7,0	14,5	76	22,5

Serie C9000 ISO B6: simple obturación = 1250 NI/min
Serie C9000 ISO B8: simple obturación = 2400 NI/min

9410U Enchufe con válvula, conexión LF 3000® con muelle de protección espiral

Polímero técnico, latón niquelado, NBR

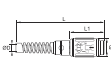

DN	ØD	G	L	L1
5,5	8 9410U06 08	31,5	145	56
5,5	9410U06 10	31,5	145	56
8	9410U08 10	36,5	155	63
8	9410U08 12	36,5	165	63

Serie C9000 ISO B6: simple obturación = 1250 NI/min
Serie C9000 ISO B8: simple obturación = 2400 NI/min

9440U Enchufe Y, rosca hembra BSPP

Polímero técnico, latón niquelado, NBR

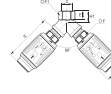

DN	C	E	F	F1	G	H	H1
5,5	G3/8 9440U06 17	11,5	19	20	31,5	70	16
8	G1/2 9440U08 21	14	22	25	36,5	80	19

Serie C9000 ISO B6: simple obturación = 1250 NI/min
Serie C9000 ISO B8: simple obturación = 2400 NI/min

Serie C9000 - Tecnología de corredera de giro con descompresión



Sistema de purga automática

9087U Acoplador sin válvula, rosca macho BSPP

Acero niquelado, polímero técnico



DN	C		E	F	L	L1
5,5	G1/4	9087U06 13	7	16	37	24
	G3/8	9087U06 17	7	20	37	24
	G1/2	9087U06 21	9	24	39	24
8	G1/4	9087U08 13	7	16	38	26
	G3/8	9087U08 17	7	20	39	26
	G1/2	9087U08 21	9	24	42	26

Sin obturación

9086U Acoplador sin válvula, rosca hembra BSPP

Acero tratado

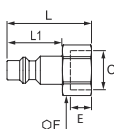

DN	C		E	F	L	L1
5,5	G3/8	9086 23 17	9	19	36	24

Sin obturación Acoplador de la serie 30 (DN 8,5) compatible con los enchufes ISO B de la serie C 9000 (DN 8)

9080U Acoplador sin válvula, conexión LF 3000®, con muelle de protección en espiral

Acero niquelado, NBR

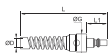

DN	ØD		G	L	L1
5,5	8	9080U06 08	24	112	24
5,5		9080U06 10	24	112	24
8	10	9080U08 10	24	114	26
8	12	9080U08 12	29,5	125	26

Sin obturación

9094U Acoplador sin válvula, con espiga acanalada para manguera

Acero niquelado



DN	ØD		F	L	L1	L2
5,5	6	9094U06 06	14	51	24	25
	8	9094U06 08	14	51	27	25
	10	9094U06 10	14	51	24	25
8	8	9094U08 08	17	51	24	25
	10	9094U08 10	17	51	27	25
	13	9094U08 13	17	51	24	25

Sin obturación

Serie 21 - Sistemas codificados

Diámetro nominal
5 = 20 mm²



Sistema de enchufe automático industrial codificado desarrollado sobre la base de la serie 21 con una tasa de caudal superior a la media para medios líquidos y gaseosos.
Sistema de enchufe automático con operación de una sola mano. La codificación mecánica del enchufe automático y del tapón ofrece una garantía para evitar confusiones entre los medios al acoplar, que se complementa con la codificación por colores de los manguitos anodizados.

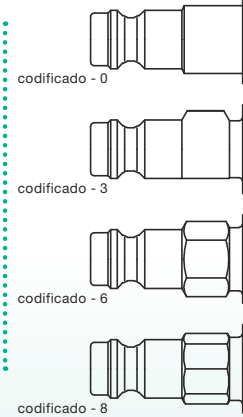

KA Simple obturación

Presión de trabajo*:
hasta 12 bar

Material:

- Enchufe: Latón o latón niquelado
- Acoplador: Latón niquelado
- Junta: NBR

Temperatura de trabajo:
-20°C hasta +100°C (NBR)

Caudal de aire:
550 l/min.
presión de entrada 6 bar, caída de presión 0,5 bar

Caudal de agua:
7 l/min.
caída de presión de 0,5 bar

KB Doble obturación

Presión de trabajo*:
hasta 35 bar

Material:

- Enchufe: Latón
- Acoplador: Latón
- Junta: NBR

Temperatura de trabajo:
-20°C hasta +100°C (NBR)

Caudal de aire:
310 l/min.
presión de entrada 6 bar, caída de presión 0,5 bar

Caudal de agua:
2,7 l/min.
caída de presión de 0,5 bar

* máxima presión estática de trabajo con un factor de diseño de 4 a 1.

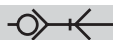

Simple obturación

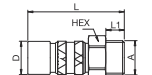
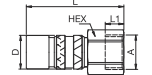
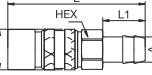
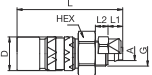

latón niquelado

conexión A	HEX	L	L1	L2	D	G	●	▲	◆	●
							0	3	6	8
							Referencia	Referencia	Referencia	Referencia
	G1/8	14	47	7	16		21KAAW10MPN0	21KAAW10MPN3	21KAAW10MPN6	21KAAW10MPN8
21KAAW Enchufe con válvula, rosca macho	G1/4	17	47	9	16		21KAAW13MPN0	21KAAW13MPN3	21KAAW13MPN6	21KAAW13MPN8
	G1/8	14	47	7	16		21KAIW10MPN0	21KAIW10MPN3	21KAIW10MPN6	21KAIW10MPN8
21KAIW Enchufe con válvula, rosca hembra	G1/4	17	47	9	16		21KAIW13MPN0	21KAIW13MPN3	21KAIW13MPN6	21KAIW13MPN8
	4	14	69	17	16		21KATF04MPN0	21KATF04MPN3	21KATF04MPN6	21KATF04MPN8
21KATF Enchufe con válvula, conexión manguera	6	14	69	17	16		21KATF06MPN0	21KATF06MPN3	21KATF06MPN6	21KATF06MPN8
	4 x 6	14	51	7	6	M10x1	21KAK006MPN0	21KAK006MPN3	21KAK006MPN6	21KAK006MPN8
21KAKO Enchufe con válvula, con conexión de manguera de plástico	6 x 8	14	51	7	6	M10x1	21KAK008MPN0	21KAK008MPN3	21KAK008MPN6	21KAK008MPN8



Serie 21 - Sistemas codificados



Simple obturación

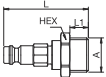

latón niquelado

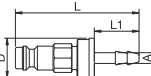
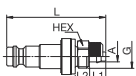
	conexión A	HEX	L	L1	L2	D	G	0 Referencia	3 Referencia	6 Referencia	8 Referencia
	G1/8	17	39,5	7				21SFAW10MXN0	21SFAW10MXN3	21SFAW10MXN6	21SFAW10MXN8
21SFAW Acoplador sin válvula, rosca macho	G1/4	17	41,5	9				21SFAW13MXN0	21SFAW13MXN3	21SFAW13MXN6	21SFAW13MXN8
	G1/8	17	38,5	7				21SFIW10MXN0	21SFIW10MXN3	21SFIW10MXN6	21SFIW10MXN8
21SFIW Acoplador sin válvula, rosca hembra	G1/4	17	39	9				21SFIW13MXN0	21SFIW13MXN3	21SFIW13MXN6	21SFIW13MXN8
	4		47	17		15		21SFTF04MXN0	21SFTF04MXN3	21SFTF04MXN6	21SFTF04MXN8
21SFTF Acoplador sin válvula, conexión manguera	6		47	17		15		21SFTF06MXN0	21SFTF06MXN3	21SFTF06MXN6	21SFTF06MXN8
	4 x 6		43	7	6	15	M10x1	21SFKO06MXN0	21SFKO06MXN3	21SFKO06MXN6	21SFKO06MXN8
21SFKO Acoplador sin válvula, con conexión de manguera de plástico	6 x 8		43,5	7	6	15	M12x1	21SFKO08MXN0	21SFKO08MXN3	21SFKO08MXN6	21SFKO08MXN8



Doble obturación

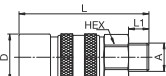
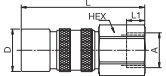
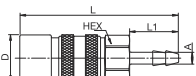
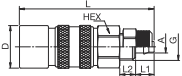

latón niquelado

	conexión A	HEX	L	L1	L2	D	G	0 Referencia	3 Referencia	6 Referencia	8 Referencia
	G1/8	14	47	7		16		21KBAW10MPN0	21KBAW10MPN3	21KBAW10MPN6	21KBAW10MPN8
21KBAW Enchufe con válvula, rosca macho	G1/4	17	47	9		16		21KBAW13MPN0	21KBAW13MPN3	21KBAW13MPN6	21KBAW13MPN8
	G1/8	14	47	7		16		21KBIW10MPN0	21KBIW10MPN3	21KBIW10MPN6	21KBIW10MPN8
21KBIW Enchufe con válvula, rosca hembra	G1/4	17	47	9		16		21KBIW13MPN0	21KBIW13MPN3	21KBIW13MPN6	21KBIW13MPN8
	4		69	17		16		21KBTf04MPN0	21KBTf04MPN3	21KBTf04MPN6	21KBTf04MPN8
21KBTf Enchufe con válvula, conexión manguera	6		69	17		16		21KBTf06MPN0	21KBTf06MPN3	21KBTf06MPN6	21KBTf06MPN8
	4 x 6		51	7	6	16	M10x1	21KBKO06MPN0	21KBKO06MPN3	21KBKO06MPN6	21KBKO06MPN8
21KBKO Enchufe con válvula, con conexión de manguera de plástico	6 x 8		51	7	6	16	M10x1	21KBKO08MPN0	21KBKO08MPN3	21KBKO08MPN6	21KBKO08MPN8

Serie 21 - Sistemas codificados

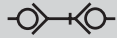

Doble obturación

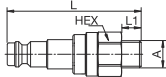
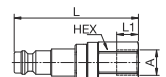
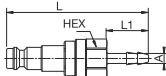
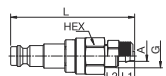

latón niquelado

	conexión A	HEX	L	L1	L2	D	G	0 Referencia	3 Referencia	6 Referencia	8 Referencia
 21SBAW Acoplador con válvula, rosca macho	G1/8	14	48	7				21SBAW10MPN0	21SBAW10MPN3	21SBAW10MPN6	21SBAW10MPN8
	G1/4	17	50	9				21SBAW13MPN0	21SBAW13MPN3	21SBAW13MPN6	21SBAW13MPN8
 21SBIW Acoplador con válvula, rosca hembra	G1/8	14	48	7				21SBIW10MPN0	21SBIW10MPN3	21SBIW10MPN6	21SBIW10MPN8
	G1/4	17	50	9				21SBIW13MPN0	21SBIW13MPN3	21SBIW13MPN6	21SBIW13MPN8
 21SBTF Acoplador con válvula, conexión manguera	4	14	58	17				21SBTF04MPN0	21SBTF04MPN3	21SBTF04MPN6	21SBTF04MPN8
	6	14	58	17				21SBTF06MPN0	21SBTF06MPN3	21SBTF06MPN6	21SBTF06MPN8
 21SBK0 Acoplador con válvula, con conexión de manguera de plástico	4 x 6	14	54	7	6		M10x1	21SBK006MPN0	21SBK006MPN3	21SBK006MPN6	21SBK006MPN8
	6 x 8	14	54	7	6		M12x1	21SBK008MPN0	21SBK008MPN3	21SBK008MPN6	21SBK008MPN8

Serie 25 - Sistemas codificados

Diámetro nominal
7,8 = 48 mm²



Sistema de enchufe automático industrial codificado desarrollado sobre la base de la serie 25. Sistema de enchufe automático con operación de una sola mano. Válvula de alto caudal para un flujo óptimo y una baja caída de presión. La codificación mecánica del enchufe automático y del tapón ofrece una garantía para evitar confusiones entre los medios al acoplar, que se complementa con la codificación por colores de los manguitos anodizados. Los acoplamientos de doble cierre y de paso recto están disponibles bajo pedido. No se pueden interconectar con la serie 25 estándar de Rectus.

codificado - 0

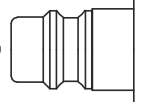

codificado - 3

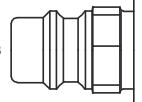

codificado - 6

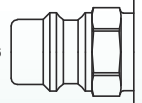

codificado - 8

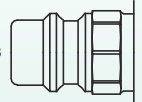

KA Simple obturación

Presión de trabajo*:
hasta 12 bar

Material:

- Enchufe: Latón o latón niquelado
- Acoplador: Latón niquelado
- Seals: NBR

Temperatura de trabajo:
-20°C hasta +100°C (NBR)

Caudal de aire:

1 800 l/min.
presión de entrada 6 bar, caída de presión 0,5 bar

Caudal de agua:

28 l/min.
caída de presión de 0,5 bar

KB Doble obturación

Presión de trabajo*:
hasta 35 bar

Material:

- Enchufe: Latón / acero niquelado
- Acoplador: Latón niquelado
- Junta: NBR

Temperatura de trabajo:
-20°C hasta +100°C (NBR)

Caudal de aire:

710 l/min.
presión de entrada 6 bar, caída de presión 0,5 bar

Caudal de agua:

7,1 l/min.
caída de presión de 0,5 bar

* máxima presión estática de trabajo con un factor de diseño de 4 a 1.

Serie 25 - Sistemas codificados



Simple obturación



latón niquelado

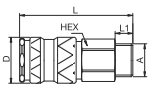
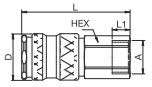
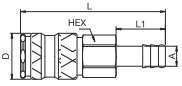

conexión A	HEX	L	L1	L2	D	G	●	▲	◆	●
							0	3	6	8
							Referencia	Referencia	Referencia	Referencia
 25KAAW Enchufe con válvula, rosca macho	G1/4	19	60	9	23		25KAAW13BPN0	25KAAW13BPN3	25KAAW13BPN6	25KAAW13BPN8
	G3/8	19	58	9	23		25KAAW17BPN0	25KAAW17BPN3	25KAAW17BPN6	25KAAW17BPN8
	G1/2	22	61	12	23		25KAAW21BPN0	25KAAW21BPN3	25KAAW21BPN6	25KAAW21BPN8
 25KAIW Enchufe con válvula, rosca hembra	G1/4	19	56	10	23		25KAIW13BPN0	25KAIW13BPN3	25KAIW13BPN6	25KAIW13BPN8
	G3/8	19	55	9	23		25KAIW17BPN0	25KAIW17BPN3	25KAIW17BPN6	25KAIW17BPN8
	G1/2	24	58	12	23		25KAIW21BPN0	25KAIW21BPN3	25KAIW21BPN6	25KAIW21BPN8
 25KATF Enchufe con válvula, conexión manguera	6	19	74	25	23		25KATF06BPN0	25KATF06BPN3	25KATF06BPN6	25KATF06BPN8
	9	19	74	25	23		25KATF09BPN0	25KATF09BPN3	25KATF09BPN6	25KATF09BPN8
	13	19	74	25	23		25KATF13BPN0	25KATF13BPN3	25KATF13BPN6	25KATF13BPN8



Simple obturación

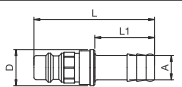

latón niquelado

conexión A	HEX	L	L1	L2	D	G	●	▲	◆	●
							0	3	6	8
							Referencia	Referencia	Referencia	Referencia
 26SFAW Acoplador sin válvula, rosca macho	G1/4	17	36,5	9			26SFAW13MXN0	26SFAW13MXN3	26SFAW13MXN6	26SFAW13MXN8
	G3/8	19	36,5	9			26SFAW17MXN0	26SFAW17MXN3	26SFAW17MXN6	26SFAW17MXN8
 26SFIW Acoplador sin válvula, rosca hembra	G1/4	17	36,5	10			26SFIW13MXN0	26SFIW13MXN3	26SFIW13MXN6	26SFIW13MXN8
	G3/8	19	36,5	10			26SFIW17MXN0	26SFIW17MXN3	26SFIW17MXN6	26SFIW17MXN8
 26SFTF Acoplador sin válvula, conexión manguera	6		50,5	25	15		26SFTF06MXN0	26SFTF06MXN3	26SFTF06MXN6	26SFTF06MXN8
	9		50,5	25	15		26SFTF09MXN0	26SFTF09MXN3	26SFTF09MXN6	26SFTF09MXN8

Serie 25 - Sistemas codificados

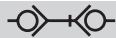

Doble obturación

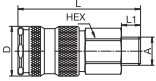
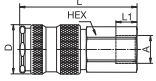
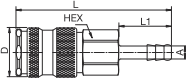

latón niquelado

	conexión A	HEX	L	L1	L2	D	G	0 Referencia	3 Referencia	6 Referencia	8 Referencia
 25KBAW Enchufe con válvula, rosca macho	G1/4	19	60	9		23		25KBAW13BPNO	25KBAW13BP3	25KBAW13BPN6	25KBAW13BPN8
	G3/8	19	58	9		23		25KBAW17BPNO	25KBAW17BP3	25KBAW17BPN6	25KBAW17BPN8
	G1/2	22	61	12		23		25KBAW21BPNO	25KBAW21BP3	25KBAW21BPN6	25KBAW21BPN8
 25KBIW Enchufe con válvula, rosca hembra	G1/4	19	56	10		23		25KBIW13BPNO	25KBIW13BP3	25KBIW13BPN6	25KBIW13BPN8
	G3/8	19	55	9		23		25KBIW17BPNO	25KBIW17BP3	25KBIW17BPN6	25KBIW17BPN8
	G1/2	24	58	12		23		25KBIW21BPNO	25KBIW21BP3	25KBIW21BPN6	25KBIW21BPN8
 25KBT Enchufe con válvula, conexión manguera	6	19	74	25		23		25KBT06BPNO	25KBT06BP3	25KBT06BPN6	25KBT06BPN8
	9	19	74	25		23		25KBT09BPNO	25KBT09BP3	25KBT09BPN6	25KBT09BPN8
	13	19	74	25		23		25KBT13BPNO	25KBT13BP3	25KBT13BPN6	25KBT13BPN8



Doble obturación

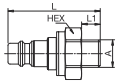
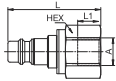
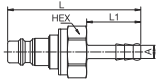

latón niquelado

	conexión A	HEX	L	L1	L2	D	G	0 Referencia	3 Referencia	6 Referencia	8 Referencia
 25SBAW Acoplador con válvula, rosca macho	G1/4	22	44,5	9				25SBAW13MPNO	25SBAW13MP3	25SBAW13MPN6	25SBAW13MPN8
	G3/8	22	44,5	9				25SBAW17MPNO	25SBAW17MP3	25SBAW17MPN6	25SBAW17MPN8
 25SBIW Acoplador con válvula, rosca hembra	G1/4	22	44,5	10				25SBIW13MPNO	25SBIW13MP3	25SBIW13MPN6	25SBIW13MPN8
	G3/8	22	44,5	9				25SBIW17MPNO	25SBIW17MP3	25SBIW17MPN6	25SBIW17MPN8
 25SBTF Acoplador con válvula, conexión manguera	6	21	61,5	25				25SBTF06MPNO	25SBTF06MP3	25SBTF06MPN6	25SBTF06MPN8
	9	21	61,5	25				25SBTF09MPNO	25SBTF09MP3	25SBTF09MPN6	25SBTF09MPN8

Accesorios

DN Unión igual, rosca macho

Latón o acero inoxidable

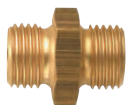

A		HEX	L	Versión
G1/8 x G1/8 *	DN10/10	14	19	Latón
G1/8 x G1/4 *	DN10/13	17	19,5	Latón
G1/8 x G3/8 **	DN10/17	19	21	Latón
G1/4 x G1/4 *	DN13/13	17	22	Latón
G1/4 x G1/4 *	DN13/13R	17	22	AISI 303
R1/4 x R1/4 con.	DN13/13K	14	30	Latón
G1/4 x G3/8 **	DN13/17	19	22,5	Latón
G1/4 x G3/8 **	DN13/17R	19	22,5	AISI 303
G1/4 x G3/8 ext. **	DN13/17V	19	24,5	Latón
G1/4 x G1/2 *	DN13/21	24	25,5	Latón
G3/8 x G3/8 **	DN17/17	19	23	Latón
G3/8 x G3/8 **	DN17/17R	19	23	AISI 303
G3/8 x G3/8 ext. **	DN17/17V	19	27	Latón
R3/8 x R3/8 con.	DN17/17K	17	30	Latón
G3/8 x G1/2 **	DN17/21	24	26	Latón
G3/8 x G1/2 **	DN17/21R	24	26	AISI 303
G3/8 x G3/4 **	DN17/26	32	29,5	Latón
G1/2 x G1/2 *	DN21/21	24	28	Latón
G1/2 x G1/2 *	DN21/21R	24	28	AISI 303
R1/2 x R1/2 con.	DN21/21K	22	34	Latón
G1/2 x G3/4 *	DN21/26	32	31,5	Latón
G1/2 x G1 *	DN21/33	36	36,5	Latón
G3/4 x G3/4 *	DN26/26	32	33	Latón
G3/4 x G1 *	DN26/33	36	34	Latón
G1 x G1 *	DN33/33	36	37	Latón

* Cono interior 45°

** Cono interior 45°, utilizable sólo junto con la Tuerca UR17S

LD Unión, rosca macho ajustable

Latón



A		HEX	L
R1/8 x R1/8	LD10/10K	15	27
R1/4 x R1/4	LD13/13K	19	34
R3/8 x R3/8	LD17/17K	22	37
R1/2 x R1/2	LD21/21K	27	44,5
R3/4 x R3/4	LD26/26K	36	53
R1 x R1	LD33/33K	46	64

RK Reductor corto

Latón



	HEX	L
RK05/10	14	11
RK05/13	17	12,5
RK10/13	17	12,5
RK10/17	19	13
RK10/21	24	17
RK13/17	19	14
RK13/21	24	17
RK17/21	24	17
RK17/26	32	18
RK21/26	32	20,5
RK21/33	36	21,5
RK26/33	36	21,5

C1: rosca macho C2: rosca hembra

RL Reductor largo

Latón



	HEX	L
RL05/05	8	15
RL05/10	14	17
RL10/10*	14	23
RL10/13*	17	26
RL13/10*	17	26
RL13/13*	17	28
RL13/17*	19	29
RL17/13*	19	29
RL17/17*	19	29
RL17/21*	24	32
RL21/17*	24	34
RL21/21*	24	34
RL21/26*	32	31

* Cono interno 45°

C1: rosca macho C2: rosca hembra

MU Manguito

Latón



A		HEX	L
M5	MU05	8	12
G1/8	MU10	14	22
G1/4	MU13	17	26
G3/8	MU17	22	26
G1/2	MU21	27	30
G3/4	MU26	32	36
G1	MU33	41	40

Accesorios

WS Codo de 90°

Latón

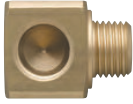

A	L
G1/8 WS10	16
G1/4 WS13	22
G3/8 WS17	27

FD Arandela, Fibra

Fibra



A	L
Joint M5 FD05	
Joint G1/8 FD10	
Joint G1/4 FD13	
Joint G3/8 FD17	
Joint G1/2 FD21	
Joint G3/4 FD26	

KM Tuerca de pasamuros

Latón



A	HEX
G1/8 KM10W	15
G1/4 KM13W	17
G3/8 KM17W	22
G1/2 KM21W	27
G3/4 KM26W	30

AD Arandela, aluminio

Aluminio



A	L
Joint G1/8 AD10	
Joint G1/4 AD13	
Joint G3/8 AD17	
Joint G1/2 AD21	
Joint G3/4 AD26	

VZ Tapón ciego

Latón



A	HEX	L
M5 (head pipe) VZ05	8	8
G1/8 VZ10	5	11
G1/4 VZ13	6	15
G3/8 VZ17	8	15
G1/2 VZ21	10	18
G3/4 VZ26	12	20

TI Te hembra

Latón



A	L
G1/8 TI10	34
G1/4 TI13	38,5
G3/8 TI17	44
G1/2 TI21	44
G3/4 TI26	50
G1 TI33	64,5

PD Arandela, PVC

PVC



A	L
Joint M5 PD05	
Joint G1/8 PD10	
Joint G1/4 PD13	
Joint G3/8 PD17	
Joint G1/2 PD21	
Joint G3/4 PD26	

WI Codo hembra

Latón



A	L
G1/8 WI10	25
G1/4 WI13	29
G3/8 WI17	35
G1/2 WI21	40
G3/4 WI26	47
G1 WI33	55

con el cono interior

Accesorios

YA Macho central hembra Y

Latón



A



HEX

R1/8 o. / G1/8 i.	YA10	13
R1/4 o., G1/4 i.	YA13	17
R3/8 o., G3/8 i.	YA17	20
R1/2 o., G1/2 i.	YA21	25

2x rosca hembra/ 1x rosca macho con.

WD Colector

Aluminio anodizado



A



G3/8 i.	WD17
G1/2 i.	WD21

YI hembra Y

Latón



A



HEX

G1/8	YI10	13
G1/4	YI13	17
G3/8	YI17	20
G1/2	YI21	25

3x rosca hembra

FA Racor articulado

Acero niquelado



A



HEX L

G1/4 i. x G1/4 o.	FA13A13ISPN	17	52
G3/8 i. x G3/8 o.	FA17A17ISPN	21	58

ZO Colector de 2 vías

Latón



A



L

G3/8 i.	Z017	47
G1/2 i.	Z021	55

SK Protección contra el polvo para el acoplamiento y el enchufe

Thermo Flex o Euro Flex



	Materiales	Versión	Resistencia a las llamas	Temperaturas	Color
SK12S	Thermo Flex	universal	UL-VO	-25°C hasta 120°C	Azul
SK16S	Euro Flex	universal	UL-VO	-25°C hasta 120°C	Rojo
SK23S	Thermo Flex	universal	UL-VO	-25°C hasta 120°C	Azul
SK27S	Thermo Flex	universal	UL-VO	-25°C hasta 120°C	Azul

DO Colector de 3 vías

Latón



A



L

G3/8 i.	D017	61
G1/2 i.	D021	67

Serie 86/87/88

Diámetro nominal
6/9/13



Las series de acoplamientos Rectus Moldite 86, 87 y 88 se desarrollaron especialmente para conectar líneas de refrigerante y moldes de inyección. Los enchufes avellanados se pueden conectar y desconectar fácilmente gracias al manguito extendido. Las conexiones angulares evitan que se formen pliegues en la manguera.

- Disponible en:
 - versiones de simple obturación, de doble obturación o de paso directo
- Los acoplamientos de cierre (con válvula) están equipados con manguitos niquelados para una rápida y precisa diferenciación visual

Serie 86



Serie 87

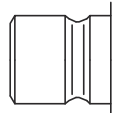

Serie 88

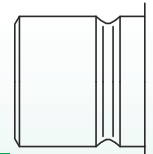

KF Sin obturación

Presión de trabajo*:
hasta 15 bar

Material:

- Enchufe: Latón
- Acoplador: Latón
- Junta: FKM

Temperatura de trabajo:
-15°C hasta +200°C (FKM)

Caudal de agua:

- Serie 86: 17 l/min.
- Serie 87: 29 l/min.
- Serie 88: 94 l/min.

caída de presión de 0,5 bar

KA Simple obturación

Presión de trabajo*:
hasta 15 bar

Material:

- Enchufe: Latón
- Acoplador: Latón
- Junta: FKM

Temperatura de trabajo:
-15°C hasta +200°C (FKM)

Caudal de agua:

- Serie 86: 9 l/min.
- Serie 87: 16 l/min.
- Serie 88: 55 l/min.

caída de presión de 0,5 bar

KB Doble obturación

Presión de trabajo*:
hasta 15 bar

Material:

- Enchufe: Latón
- Acoplador: Latón
- Junta: FKM

Temperatura de trabajo:
-15°C hasta +200°C (FKM)

Caudal de agua:

- Serie 86: 8 l/min.
- Serie 87: 15 l/min.

caída de presión de 0,5 bar

* máxima presión estática de trabajo con un factor de diseño de 4 a 1.

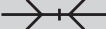
 Sin obturación

86/87/88KFAW Enchufe sin válvula, rosca macho

Latón, FKM

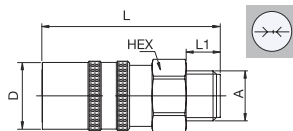

DN	Serie	A	HEX	L	L1	D
6	86	G1/4	86KFAW13MVX	17	47	9 18
		G3/8	86KFAW17MVX	19	47	9 18
	G1/4	87KFAW13MVX	22	56,5	9 24	
9	87	G3/8	87KFAW17MVX	22	56,5	9 24
		G1/2	87KFAW21MVX	22	59,5	12 24
13	88	G1/2	88KFAW21MVX	30	73	12 32

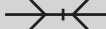
 Sin obturación

86/87/88KFIW Enchufe sin válvula, rosca hembra

Latón, FKM

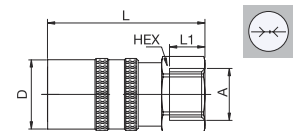

DN	Serie	A	HEX	L	L1	D
6	86	G1/8	86KFIW10MVX	17	40	12 18
		G1/4	86KFIW13MVX	17	40	12 18
9	87	G1/4	87KFIW13MVX	21	51,5	10 24
		G3/8	87KFIW17MVX	21	51,5	10 24
13	88	G1/2	88KFIW21MVX	30	68	12 32

Series 86/87/88



Sin obturación

86/87/88KFTF Enchufe sin válvula, conexión manguera

Latón, FKM

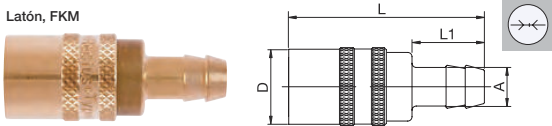

DN	Serie	A		L	L1	D
6	86	6	86KFTF06MVX	46	17	18
		9	86KFTF09MVX	46	22	18
9	87	9	87KFTF09MVX	64	22	24
		13	87KFTF13MVX	66,5	25	24
13	88	19	88KFTF19MVX	89	32	32

86/87/88KFTR Enchufe sin válvula, conexión manguera 90°

Latón, FKM

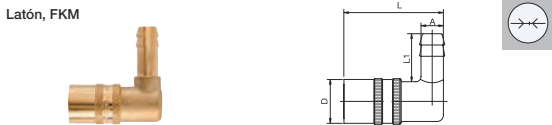

DN	Serie	A		L	L1	D
6	86	6	86KFTR06MVX	40	17	18
		9	86KFTR09MVX	40	22	18
9	87	9	87KFTR09MVX	56	22	24
		13	87KFTR13MVX	56	28,5	24
13	88	19	88KFTR19MVX	77	32	32

86/87KFTH Enchufe sin válvula, conexión manguera 45°

Latón, FKM

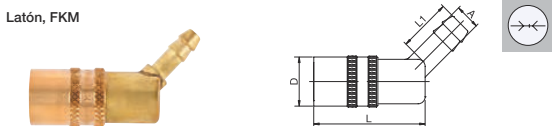

DN	Serie	A		L	L1	D
6	86	6	86KFTH06MVX	40	17	18
		9	86KFTH09MVX	40	22	18
9	87	9	87KFTH09MVX	56	22	24
		13	87KFTH13MVX	56	25	24



Sin obturación

86/87KFTP Enchufe sin válvula, Push-Lok

Latón, FKM

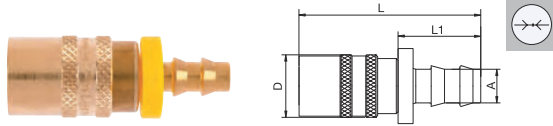

DN	Serie	A		L	L1	D
6	86	6	86KFTP06MVX	49	20,4	18
		10	86KFTP10MVX	53	24,2	18
9	87	10	87KFTP10MVX	65,5	24,2	24
		13	87KFTP13MVX	69,5	27,9	24

86/87KFPR Enchufe sin válvula, Push-Lok 90°

Latón, FKM

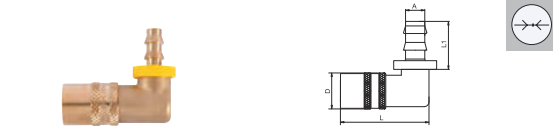

DN	Serie	A		L	L1	D
6	86	6	86KFPR06MVX	45	20,4	18
		10	86KFPR10MVX	45	24,2	18
9	87	10	87KFPR10MVX	61,5	24,2	24
		13	87KFPR13MVX	61,5	27,9	24

86/87KFPH Enchufe sin válvula, Push-Lok 45°

Latón, FKM

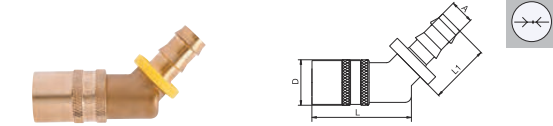

DN	Serie	A		L	L1	D
6	86	6	86KFPH06MVX	40	20,4	18
		10	86KFPH10MVX	40	24,2	18
9	87	10	87KFPH10MVX	56	24,2	24
		13	87KFPH13MVX	56	27,9	24

Series 86/87/88

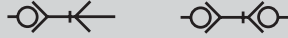

Simple obturación/Doble obturación

86/87/88KBAW Enchufe con válvula, rosca macho

Latón, FKM

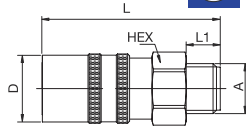

DN	Serie	A	HEX	L	L1	D
6	86	G1/4	86KBAW13MVX	17	47	9 18
		G3/8	86KBAW17MVX	19	47	9 18
9	87	G1/4	87KBAW13MVX	22	56,5	9 24
		G3/8	87KBAW17MVX	22	56,5	9 24
		G1/2	87KBAW21MVX	22	59,5	12 24
13	88	G1/2	88KAAW21MVX	30	73	12 32

86/87/88KBIW Enchufe con válvula, rosca hembra

Latón, FKM

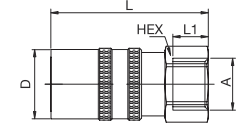

DN	Serie	A	HEX	L	L1	D
6	86	G1/8	86KBIW10MVX	17	40	12 18
		G1/4	86KBIW13MVX	17	40	12 18
9	87	G1/4	87KBIW13MVX	21	51,5	10 24
		G3/8	87KBIW17MVX	21	51,5	10 24
13	88	G1/2	88KAIW21MVX	30	68	12 32

86/87/88KBTf Enchufe con válvula, conexión manguera

Latón, FKM

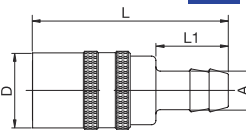

DN	Serie	A	L	L1	D
6	86	6	86KBTf06MVX	46	17 18
		9	86KBTf09MVX	46	22 18
9	87	9	87KBTf09MVX	64	22 24
		13	87KBTf13MVX	66,5	25 24
13	88	19	88KATf19MVX	89	32 32

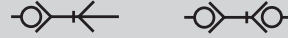

Simple obturación/Doble obturación

86/87/88KBTR Enchufe con válvula, conexión manguera 90°

Latón, FKM

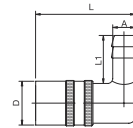

DN	Serie	A	L	L1	D
6	86	6	86KBTR06MVX	40	17 18
		9	86KBTR09MVX	40	22 18
9	87	9	87KBTR09MVX	56	22 24
		13	87KBTR13MVX	56	28,5 24
13	88	19	88KATR19MVX	77	32 32

86/87KBTH Enchufe con válvula, conexión manguera 45°

Latón, FKM

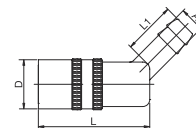

DN	Serie	A	L	L1	D
6	86	6	86KBTH06MVX	40	17 18
		9	86KBTH09MVX	40	22 18
9	87	9	87KBTH09MVX	56	22 24
		13	87KBTH13MVX	56	25 24

86/87KBTP Enchufe con válvula, Push-Lok

Latón, FKM

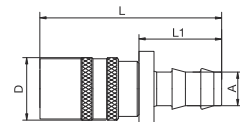

DN	Serie	A	L	L1	D
6	86	6	86KBTP06MVX	49	20,4 18
		10	86KBTP10MVX	53	24,2 18
9	87	10	87KBTP10MVX	65,5	24,2 24
		13	87KBTP13MVX	69,5	27,9 24

Series 86/87/88

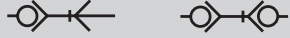

Simple obturación/Doble obturación

86/87KBPR Enchufe con válvula, Push-Lok 90°

Latón, FKM

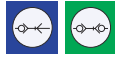
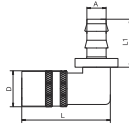

DN	Serie	A		L	L1	D
6	86	6	86KBPR06MVX	45	20,4	18
		10	86KBPR10MVX	45	24,2	18
9	87	10	87KBPR10MVX	61,5	24,2	24
		13	87KBPR13MVX	61,5	27,9	24

86/87KBPH Enchufe con válvula, Push-Lok 45°

Latón, FKM

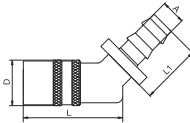

DN	Serie	A		L	L1	D
6	86	6	86KBPH06MVX	40	20,4	18
		10	86KBPH10MVX	40	24,2	18
9	87	10	87KBPH10MVX	56	24,2	24
		13	87KBPH13MVX	56	27,9	24



Sin obturación/Simple obturación

86/87/88SFA Acoplador sin válvula, macho

Latón

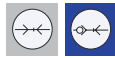
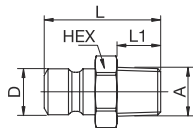

DN	Serie	A		HEX	L	L1	D
6	86	M10 x 1	86SFAM10MXX	13	23	8	9,5
		R1/8	86SFAK10MXX	13	24	9	9,5
		R1/4	86SFAK13MXX	16	29	12	9,5
		R3/8	86SFAK17MXX	19	30	12	9,5
		R1/4	87SFAK13MXX	16	34	12	13,5
9	87	R3/8	87SFAK17MXX	19	34	12	13,5
		R1/2	87SFAK21MXX	24	39	17	13,5
13	88	R1/2	88SFAK21MXX	22	44	17	20
		R3/4	88SFAK26MXX	29	45	19	20

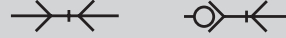

Sin obturación/Simple obturación

86/87SFAR Acoplador sin válvula, rosca macho 90°

Latón

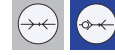
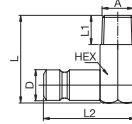

DN	Serie	A		HEX	L	L1	L2	D
6	86	R1/8	86SFAR10MXX	11	27	9	28,5	9,5
		R1/4	86SFAR13MXX	14	27	9	32	9,5
9	87	R1/4	87SFAR13MXX	15	34	9	32	13,5
		R3/8	87SFAR17MXX	19	37	12	36	13,5

86/87SFIW Acoplador sin válvula, rosca hembra

Latón

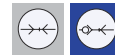
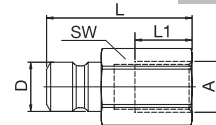

DN	Serie	A		HEX	L	L1	D
6	86	G1/8	86SFIW10MXX	13	28	11	9,5
		G1/4	86SFIW13MXX	16	32	13	9,5
9	87	G1/4	87SFIW13MXX	16	37	13	13,5
		G3/8	87SFIW17MXX	19	39	16	13,5

86/87SFTF Acoplador sin válvula, conexión manguera

Latón

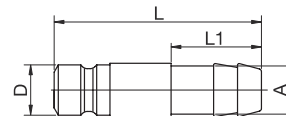

DN	Serie	A		L	L1	D
6	86	9	86SFTF09MXX	39	22	9,5
9	87	13	87SFTF13MXX	41	21	13,5

Series 86/87/88

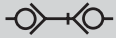

Doble obturación

86/87SBAK Acoplador con válvula, rosca macho

Latón, FKM

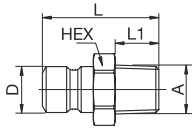
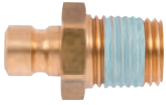

DN	Serie	A		HEX	L	L1	D
6	86	R1/4	86SBAK13MVX	6	29	14	9,5
		R1/4	87SBAK13MVX	16	34	12	13,5
9	87	R3/8	87SBAK17MVX	19	34	12	13,5



Sin obturación

86/87VN Acoplador de extensión, rosca macho

Latón



DN	Serie	A		HEX	L	L1	D
6	86	R1/8	86VN1010MXX	11	100	9	9,5
		R1/8	86VN1015MXXS_01	11	150	9	9,5
		R1/8	86VN1025MXX	11	250	9	9,5
9	87	R1/4	87VN1315MXX	15	150	12	13,5
		R1/4	87VN1325MXX	15	250	12	13,5
6	86	G1/8	86VN1010MXXS_01	11	100	60	9,5
		G1/4	86VN1310MXX	14	100	60	9,5
9	87	G1/4	87VN1310MXX	14	100	60	13,5
		G3/8	87VN1710MXX	17	100	60	13,5

Serie 86/87 - Tecnología de cierre seguro

Diámetro nominal
6/9



SL

Las series de acoplamientos Rectus Moldtite 86 y 87 con tecnología Safe-Lock se desarrollaron especialmente para conectar líneas de refrigerante y moldes de inyección. Los enchufes avellanados se pueden conectar y desconectar fácilmente gracias al manguito extendido. Las conexiones angulares evitan que se formen pliegues en la manguera.

- Disponible en versiones de simple obturación, doble obturación o directo
- Los acoplamientos de cierre (con válvula) están equipados con manguitos niquelados para una rápida y precisa diferenciación visual

Serie 86



Serie 87

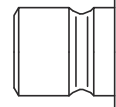

KF Sin obturación

Presión de trabajo*:
hasta 15 bar

Material:

- Enchufe: Latón
- Acoplador: Latón
- Junta: FKM

Temperatura de trabajo:
-15°C hasta +200°C (FKM)

Caudal de agua:

- Serie 86: 17 l/min.
- Serie 87: 29 l/min.

caída de presión de 0,5 bar



KA Simple obturación

Presión de trabajo*:
hasta 15 bar

Material:

- Enchufe: Latón
- Acoplador: Latón
- Junta: FKM

Temperatura de trabajo:
-15°C hasta +200°C (FKM)

Caudal de agua:

- Serie 86: 9 l/min.
- Serie 87: 16 l/min.

caída de presión de 0,5 bar



KB Doble obturación

Presión de trabajo*:
hasta 15 bar

Material:

- Enchufe: Latón
- Acoplador: Latón
- Junta: FKM

Temperatura de trabajo:
-15°C hasta +200°C (FKM)

Caudal de agua:

- Serie 86: 8 l/min.
- Serie 87: 15 l/min.

caída de presión de 0,5 bar

* máxima presión estática de trabajo con un factor de diseño de 4 a 1.



Sin obturación

86/87KFAW Enchufe sin válvula, rosca macho, Cierre de seguridad

Latón, FKM

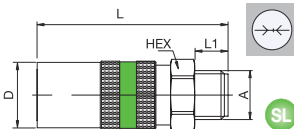

SL

DN	Serie	A	HEX	L	L1	D
6	86	G1/4	86KFAW13MVXSL	17	51,5	9 18
		G3/8	86KFAW17MVXSL	19	51,5	9 18
9	87	G1/4	87KFAW13MVXSL	22	67	9 24
		G3/8	87KFAW17MVXSL	22	67	9 24
		G1/2	87KFAW21MVXSL	22	70	12 24



Sin obturación

86/87KFTR Enchufe sin válvula, conexión manguera a 90°, Cierre de seguridad

Latón, FKM

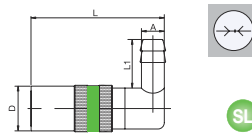

SL

DN	Serie	A	L	L1	D
6	86	9	86KFTR09MVXSL	52,5	22 18
		9	87KFTR09MVXSL	68,5	22 24
9	87	13	87KFTR13MVXSL	68,5	28,5 24

86/87KFTF Enchufe sin válvula, conexión manguera, Cierre de seguridad

Latón, FKM

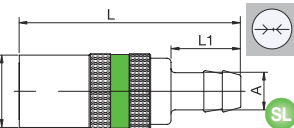

SL

DN	Serie	A	L	L1	D
6	86	9	86KFTF09MVXSL	59	22 18
		9	87KFTF09MVXSL	73	22 24
9	87	13	87KFTF13MVXSL	76	25 24

86/87KFTH Enchufe sin válvula, conexión manguera a 45°, Cierre de seguridad

Latón, FKM

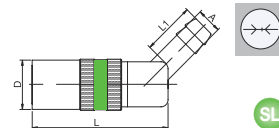

SL

DN	Serie	A	L	L1	D
6	86	9	86KFTH09MVXSL	51,5	22 18
		9	87KFTH09MVXSL	65,5	22 24
9	87	13	87KFTH13MVXSL	65,5	25 24

Serie 86/87 - Tecnología de cierre seguro

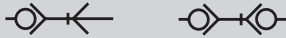

Simple obturación/Doble obturación

86/87KBAW Enchufe con válvula, rosca macho, Cierre de seguridad

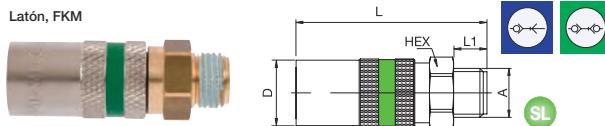

DN	Serie	A		HEX	L	L1	D
6	86	G1/4	86KBAW13MVXSL	17	51,5	9	18
		G3/8	86KBAW17MVXSL	19	51,5	9	18
9	87	G1/4	87KBAW13MVXSL	22	67	9	24
		G3/8	87KBAW17MVXSL	22	67	9	24
		G1/2	87KBAW21MVXSL	22	70	12	24

86/87KBTF Enchufe con válvula, conexión manguera, Cierre de seguridad

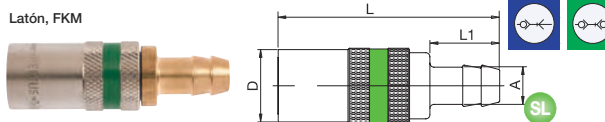

DN	Serie	A		L	L1	D
6	86	9	86KBTF09MVXSL	59	22	18
9	87	9	87KBTF09MVXSL	73	22	24
		13	87KBTF13MVXSL	76	25	24

86/87KBTR Enchufe con válvula, conexión manguera a 90°, Cierre de seguridad

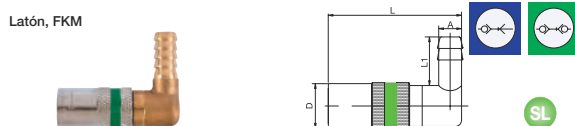

DN	Serie	A		L	L1	D
6	86	9	86KBTR09MVXSL	52,5	22	18
9	87	9	87KBTR09MVXSL	68,5	22	24
		13	87KBTR13MVXSL	68,5	28,5	24

86/87KBTH Enchufe con válvula, conexión manguera a 45°, Cierre de seguridad

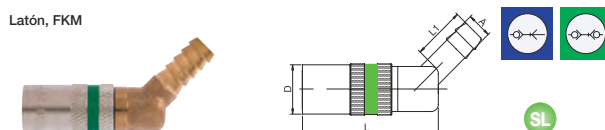

DN	Serie	A		L	L1	D
6	86	9	86KBTH09MVXSL	51,5	22	18
9	87	9	87KBTH09MVXSL	65,5	22	24
		13	87KBTH13MVXSL	65,5	25	24

Series 10/11/12

Diámetro nominal
6/9/13



Las series de acoplamientos Rectus Moldtite 10, 11 y 12 se desarrollaron especialmente para conectar líneas de refrigerante y moldes de inyección. Se destacan por su cómodo funcionamiento con una sola mano y por su fiable junta tórica. Ampliamente utilizado en Europa.

- Disponible en:
 - versiones de simple obturación, de doble obturación o de paso directo
- Los acoplamientos rectos están equipados con manguitos niquelados para una rápida y precisa diferenciación visual
- Las conexiones angulares evitan que se formen pliegues en la manguera
- Disponible a petición:
 - Las series 10/11 también están disponibles con una junta especial de alta temperatura de FFKM para aplicaciones hasta una temperatura constante de 200°C

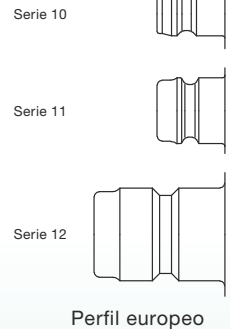

KF Sin obturación

Presión de trabajo*:
hasta 15 bar

Material:

- Enchufe: Latón
- Acoplador: Latón, acero inoxidable
- Junta: FKM

Temperatura de trabajo:
-15°C hasta +200°C (FKM)

Caudal de agua:

- Serie 10: 16 l/min.
 - Serie 11: 50 l/min.
 - Serie 12: 106 l/min.
- caída de presión de 0,5 bar

KA Simple obturación

Presión de trabajo*:
hasta 15 bar

Material:

- Enchufe: Latón
- Acoplador: Latón, acero inoxidable
- Junta: FKM

Temperatura de trabajo:
-15°C hasta +200°C (FKM)

Caudal de agua:

- Serie 10: 8 l/min.
 - Serie 11: 20 l/min.
 - Serie 12: 38 l/min.
- caída de presión de 0,5 bar

KB Doble obturación

Presión de trabajo*:
hasta 15 bar

Material:

- Enchufe: Latón
- Acoplador: Latón
- Junta: FKM

Temperatura de trabajo:
-15°C hasta +200°C (FKM)

Caudal de agua:

- Serie 10: 7 l/min.
 - Serie 11: 15 l/min.
 - Serie 12: 28 l/min.
- caída de presión de 0,5 bar

* máxima presión estática de trabajo con un factor de diseño de 4 a 1.

Sin obturación

10/11/12KFA Enchufe sin válvula, rosca macho

Latón, FKM

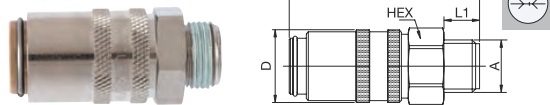

DN	Serie	A	HEX	L	L1	D
6	10	M14 x 1,5	10KFA14MVX	17	48	9 18
		G1/4	10KFA13MVX	17	48	9 18
		G3/8	10KFA17MVX	19	48	9 18
9	11	G1/4	11KFA13MVX	22	51,5	9 23
		M16 x 1,5	11KFA16MVX	22	51,5	9 23
		G3/8	11KFA17MVX	22	51,5	9 23
13	12	G1/2	12KFA21MVX	22	51,5	12 23
		G1/2	12KFA21MVX	30	74	12 32
		G3/4	12KFA26MVX	30	78	16 32

Sin obturación

10/11KFAR Enchufe sin válvula, rosca macho 90°

Latón, FKM

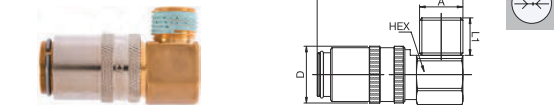

DN	Serie	A	HEX	L	L1	D
6	10	G1/4	10KFAR13MVX	17	47	12 18
		M14 x 1,5	10KFAR14MVX	17	47	12 18
		M16 x 1,5	11KFAR16MVX	22	53,5	12 23

10/11KFAH Enchufe sin válvula, rosca macho 45°

Latón, FKM

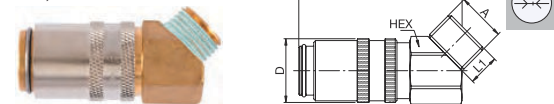

DN	Serie	A	HEX	L	L1	D
6	10	G1/4	10KFAH13MVX	17	47	9 18
		M14 x 1,5	10KFAH14MVX	17	47	9 18
		M16 x 1,5	11KFAH16MVX	22	53,5	9 23

Series 10/11/12



Sin obturación

10/11KFIW Enchufe sin válvula, rosca hembra

Latón, FKM

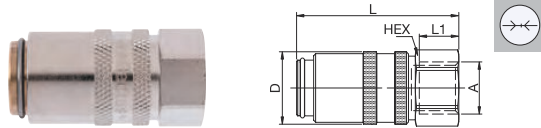

DN	Serie	A		HEX	L	L1	D
6	10	G1/4	10KFIW13MVX	17	41	10	18
		G3/8	10KFIW17MVX	19	45	10	18
9	11	G1/4	11KFIW13MVX	21	46,5	10	23
		G3/8	11KFIW17MVX	21	46,5	10	23

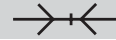

Sin obturación

10/11KFTP Enchufe sin válvula, Push-Lok

Latón, FKM

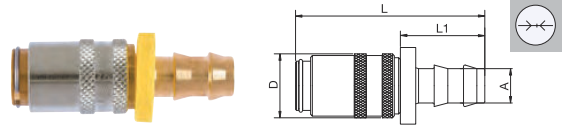

DN	Serie	A		L	L1	D
6	10	6	10KFTP06MVX	50,5	20,4	18
		10	10KFTP10MVX	54	24,2	18
9	11	10	11KFTP10MVX	61	24,2	23
		13	11KFTP13MVX	64,5	27,9	23

10/11/12KFTF Enchufe sin válvula, conexión manguera

Latón, FKM

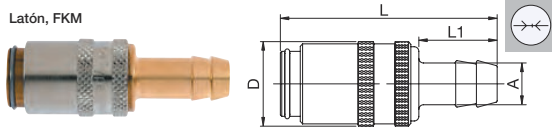

DN	Serie	A		L	L1	D
6	10	9	10KFTF09MVX	52	22	18
9	11	13	11KFTF13MVX	61,5	25	23
13	12	19	12KFTF19MVX	90	32	32

10/11KFPR Enchufe sin válvula, Push-Lok 90°

Latón, FKM

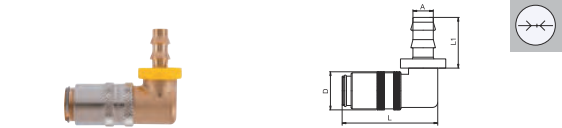

DN	Serie	A		L	L1	D
6	10	6	10KFPR06MVX	46	20,4	18
		10	10KFPR10MVX	46	24,2	18
9	11	10	11KFPR10MVX	56,5	24,2	23
		13	11KFPR13MVX	56,5	27,9	23

10/11/12KFTR Enchufe sin válvula, conexión manguera a 90°

Latón, FKM



DN	Serie	A		L	L1	D
6	10	9	10KFTR09MVX	41	22	18
9	11	13	11KFTR13MVX	51	28,5	23
13	12	19	12KFTR19MVX	78	32	32

10/11KFPH Enchufe sin válvula, Push-Lok 45°

Latón, FKM



DN	Serie	A		L	L1	D
6	10	6	10KFPH06MVX	41	20,4	18
		10	10KFPH10MVX	41	24,2	18
9	11	10	11KFPH10MVX	51	24,2	23
		13	11KFPH13MVX	51	27,9	23

10/11/12KFTH Enchufe sin válvula, conexión manguera a 45°

Latón, FKM

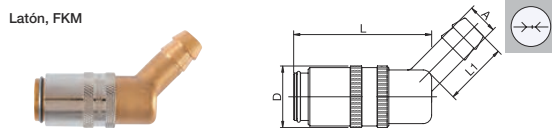

DN	Serie	A		L	L1	D
6	10	9	10KFTH09MVX	52	22	18
9	11	13	11KFTH13MVX	51	25	23
13	12	19	12KFTH19MVX	78	30	32

Series 10/11/12

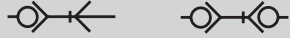

Simple obturación/Doble obturación

10/11/12KBA Enchufe con válvula, rosca macho

Latón, FKM

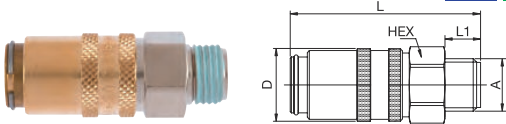

DN	Serie	A	HEX	L	L1	D	
6	10	M14 x 1,5	10KBA14MVX	17	48	9	18
		G1/4	10KBA13MVX	17	48	9	18
		G3/8	10KBA17MVX	19	48	9	18
9	11	G1/4	11KBA13MVX	22	51,5	9	23
		M16 x 1,5	11KBA16MVX	22	51,5	9	23
		G3/8	11KBA17MVX	22	51,5	9	23
13	12	G1/2	11KBA21MVX	22	51,5	12	23
		G1/2	12KBA21MVX	30	74	12	32
		G3/4	12KBA26MVX	30	78	16	32

10/11KBAR Enchufe con válvula, rosca macho 90°

Latón, FKM



DN	Serie	A	HEX	L	L1	D	
6	10	G1/4	10KBAR13MVX	17	47	12	18
		M14 x 1,5	10KBAR14MVX	17	47	12	18
9	11	M16 x 1,5	11KBAR16MVX	22	53,5	12	23

10/11KBAH Enchufe con válvula, rosca macho 45°

Latón, FKM

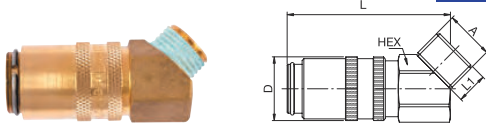

DN	Serie	A	HEX	L	L1	D	
6	10	G1/4	10KBAH13MVX	17	47	9	18
		M14 x 1,5	10KBAH14MVX	17	47	9	18
9	11	M16 x 1,5	11KBAH16MVX	22	53,5	9	23



Simple obturación/Doble obturación

10/11KBIW Enchufe con válvula, rosca hembra

Latón, FKM

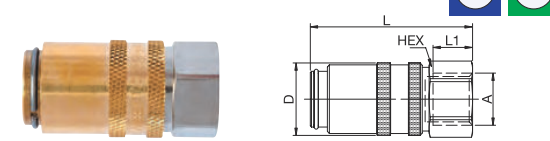

DN	Serie	A	HEX	L	L1	D	
6	10	G1/4	10KBIW13MVX	17	41	12	18
		G3/8	10KBIW17MVX	19	45	12	18
9	11	G1/4	11KBIW13MVX	21	46,5	10	23
		G3/8	11KBIW17MVX	21	46,5	10	23

10/11/12KBTF Enchufe con válvula, conexión manguera

Latón, FKM

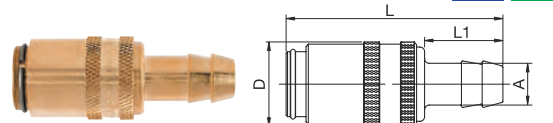

DN	Serie	A	L	L1	D	
6	10	9	10KBTFO9MVX	52	22	18
9	11	13	11KBTFI3MVX	61,5	25	23
13	12	19	12KBTFI9MVX	90	32	32

10/11/12KBTR Enchufe con válvula, conexión manguera a 90°

Latón, FKM

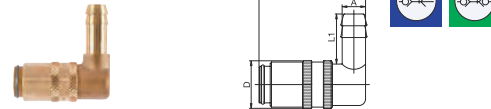

DN	Serie	A	L	L1	D	
6	10	9	10KBTR09MVX	41	22	18
9	11	13	11KBTR13MVX	51	28,5	23
13	12	19	12KBTR19MVX	78	32	32

10/11/12KBTH Enchufe con válvula, conexión manguera a 45°

Latón, FKM

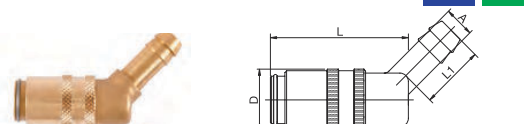

DN	Serie	A	L	L1	D	
6	10	9	10KBTH09MVX	52	22	18
9	11	13	11KBTH13MVX	51	25	23
13	12	19	12KBTH19MVX	78	30	32

Serie 10/11/12

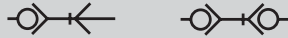

Simple obturación/Doble obturación

10/11KBTP Enchufe con válvula, Push-Lok

Latón, FKM

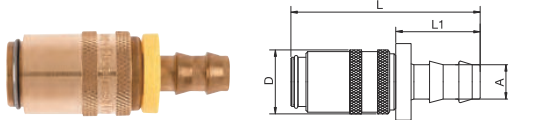

DN	Serie	A		L	L1	D
6	10	6	10KBTP06MVX	50,5	20,4	18
		10	10KBTP10MVX	54	24,2	18
9	11	10	11KBTP10MVX	61	24,2	23
		13	11KBTP13MVX	64,5	27,9	23

10/11KBPR Enchufe con válvula, Push-Lok 90°

Latón, FKM

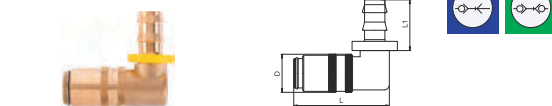

DN	Serie	A		L	L1	D
6	10	6	10KBPR06MVX	46	20,4	18
		10	10KBPR10MVX	46	24,2	18
9	11	10	11KBPR10MVX	56,5	24,2	23
		13	11KBPR13MVX	56,5	27,9	23

10/11KBPH Enchufe con válvula, Push-Lok 45°

Latón, FKM

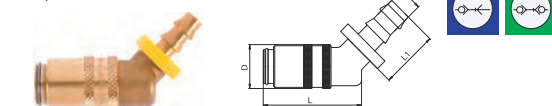

DN	Serie	A		L	L1	D
6	10	6	10KBPH06MVX	41	20,4	18
		10	10KBPH10MVX	41	24,2	18
9	11	10	11KBPH10MVX	51	24,2	23
		13	11KBPH13MVX	51	27,9	23

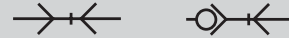

Sin obturación/Simple obturación

10/11/12SFA Acoplador sin válvula, rosca macho

Latón o acero inoxidable

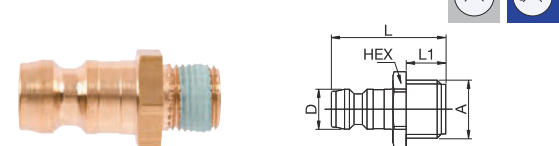

DN	Serie	A		HEX	L	L1	D	Versión
6	10	M8 x 0,75	10SFAM08MXX	11	24	7	9	Latón
		M10 x 1	10SFAM10MXX	11	24	7	9	Latón
		M10 x 1	10SFAM10RXX	11	24	7	9	AI SI 303
		G1/8	10SFAW10MXN	11	24	7	9	Latón niquelado
		G1/8	10SFAW10RXX	11	24	7	9	AI SI 303
		M12 x 1,5	10SFAM12MXX	14	27	10	9	Latón
		G1/4	10SFAW13MXN	15	26	9	9	Latón niquelado
		G1/4	10SFAW13RXX	15	26	9	9	AI SI 303
		M14 x 1,5	10SFAM14MXX	15	26	9	9	Latón
		G3/8	10SFAW17MXN	17	30	10	9	Latón niquelado
		G1/8	11SFAW10MXN	14	25	8	13,5	Latón niquelado
		G1/4	11SFAW13MXN	15	26	9	13,5	Latón niquelado
9	11	G1/4	11SFAW13RXX	15	26	9	13,5	AI SI 303
		M14 x 1,5	11SFAM14MXX	15	26	9	13,5	Latón
		M16 x 1,5	11SFAM16MXX	17	26	9	13,5	Latón
		G3/8	11SFAW17MXN	17	26	9	13,5	Latón niquelado
		G3/8	11SFAW17RXX	17	26	9	13,5	AI SI 303
		G1/2	12SFAW21MXN	22	47	12	19	Latón niquelado
13	12	G3/4	12SFAW26MXN	27	51	16	19	Latón niquelado

10/11SFAR Acoplador sin válvula, rosca macho 90° cónico

Latón

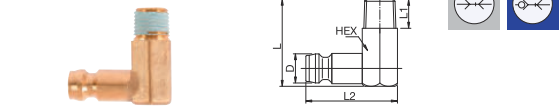

DN	Serie	A		HEX	L	L1	L2	D	Versión
6	10	M10 x 1	10SFAR10MXX	11	27	9	28,5	9	Latón
		R1/8	10SFAR10MXN	11	27	9	28,5	9	Latón niquelado
		R1/4	10SFAR13MXN	11	27	9	28,5	9	Latón niquelado
9	11	R1/4	11SFAR13MXN	15	34	11	32	13,5	Latón niquelado
		R3/8	11SFAR17MXN	15	34	11	32	13,5	Latón niquelado

Series 10/11/12

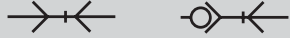

Sin obturación/Simple obturación

10/11SFIW Acoplador sin válvula, rosca hembra

Latón

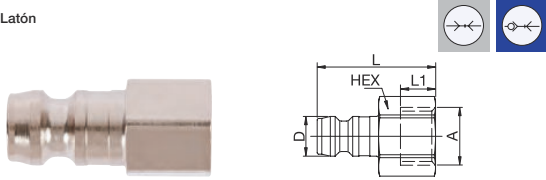

DN	Serie	A	HEX	L	L1	D	
6	10	G1/8	10SFIW10MXN	11	24	9	9
		G1/4	10SFIW13MXN	16	27	9	9
9	11	G1/4	11SFIW13MXN	16	33	10	13,5

10/11/12SFTF Acoplador sin válvula, conexión manguera

Latón

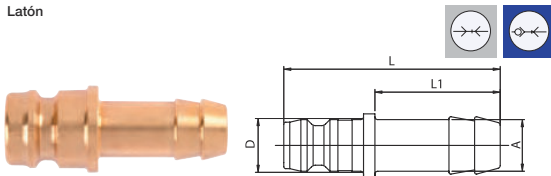

DN	Serie	A	L	L1	D	
6	10	9	10SFTF09MXX	38	22	9
		9	11SFTF09MXX	41	25	13,5
9	11	13	11SFTF13MXX	41	25	13,5
		19	12SFTF19MXX	61	32	19



Sin obturación/Simple obturación

10/11/12SBA Acoplador con válvula, rosca macho

Latón, FKM

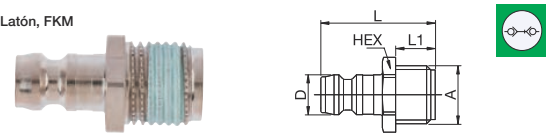

DN	Serie	A	HEX	L	L1	D	Versión	
6	10	G1/4	10SBAW13MVN	15	29	12	9	Latón niquelado
		M14 x 1,5	10SBAM14MVX	15	29	12	9	Latón
		G1/4	11SBAW13MVN	15	31	12	13,5	Latón niquelado
9	11	M16 x 1,5	11SBAM16MVX	17	30	12	13,5	Latón
		G3/8	11SBAW17MVN	17	30	12	13,5	Latón niquelado
13	12	G3/4	12SBAW26MVN	27	51	16	19	Latón niquelado



Sin obturación

10/11VN Acoplador de extensión, rosca macho continuo

Latón

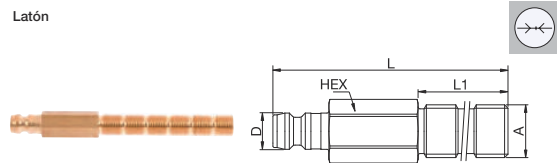

DN	Serie	A	HEX	L	L1	D	
6	10	G1/8	10VN1010MXX	11	100	60	9
		G1/4	10VN1310MXX	14	100	60	9
9	11	G1/4	11VN1310MXX	14	100	60	13,5
		G3/8	11VN1710MXX	19	100	60	13,5

10/11VNXX Acoplador de extensión, sin rosca

Latón

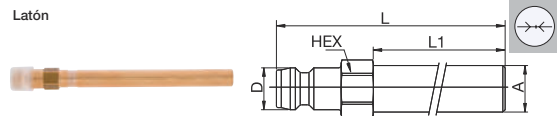

DN	Serie	A	HEX	L	L1	D	
6	10	8	10VNXX10MXX	9	100	79	9
		10	10VNXX12MXX	11	120	100	9
		10	10VNXX24MXX	11	240	220	9
9	11	14	11VNXX15MXX	15	150	125	13,5
		14	11VNXX30MXX	15	300	275	13,5

Serie 10/11 - Tecnología de cierre seguro

Diámetro nominal
6/9



SL

Las series de acoplamientos Rectus Moldtite 10 y 11 con tecnología Safe-Lock se desarrollaron especialmente para conectar líneas de refrigerante y moldes de inyección. Estos se destacan por su cómodo funcionamiento con una sola mano y una junta tórica fiable. Ampliamente utilizados en Europa.

- Disponible en:
 - versiones de simple obturación, de doble obturación o de paso directo
- Los acoplamientos rectos están equipados con manguitos niquelados para una rápida y precisa diferenciación visual
- Las conexiones angulares evitan que se formen pliegues en la manguera
- Disponible a petición:
 - Las series 10/11 también están disponibles con un sello especial de alta temperatura de FFKM para aplicaciones hasta una temperatura constante de 200°C

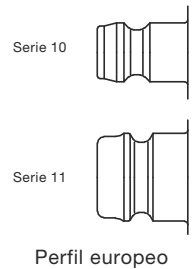

KF Sin obturación

Presión de trabajo*:
hasta 15 bar

Material:

- Enchufe: Latón
- Acoplador: Latón, acero inoxidable
- Junta: FKM

Temperatura de trabajo:
-15°C hasta +200°C (FKM)

Caudal de agua:

- Serie 10: 16 l/min.
- Serie 11: 50 l/min.

caída de presión de 0,5 bar

KA Simple obturación

Presión de trabajo*:
hasta 15 bar

Material:

- Enchufe: Latón
- Acoplador: Latón, acero inoxidable
- Junta: FKM

Temperatura de trabajo:
-15°C hasta +200°C (FKM)

Caudal de agua:

- Serie 10: 8 l/min.
- Serie 11: 20 l/min.

caída de presión de 0,5 bar

KB Doble obturación

Presión de trabajo*:
hasta 15 bar

Material:

- Enchufe: Latón
- Acoplador: Latón
- Junta: FKM

Temperatura de trabajo:
-15°C hasta +200°C (FKM)

Caudal de agua:

- Serie 10: 7 l/min.
- Serie 11: 15 l/min.

caída de presión de 0,5 bar

* máxima presión estática de trabajo con un factor de diseño de 4 a 1.

Sin obturación

10/11KFA Enchufe sin válvula, rosca macho, Cierre de seguridad

Latón, FKM

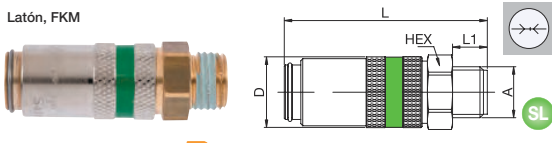

DN	Serie	A	HEX	L	L1	D	
6	10	G1/4	10KFAW13MVXSL	17	52,5	9	18
		M14 x 1,5	10KFAW14MVXSL	17	52,5	9	18
		G3/8	10KFAW17MVXSL	19	52,5	9	18
9	11	G1/4	11KFAW13MVXSL	22	62	9	24
		M16 x 1,5	11KFAW16MVXSL	22	62	9	24
		G3/8	11KFAW17MVXSL	22	62	9	24
		G1/2	11KFAW21MVXSL	22	65	12	24

Sin obturación

10/11KFTR Enchufe sin válvula, conexión manguera a 90°, Cierre de seguridad

Latón, FKM

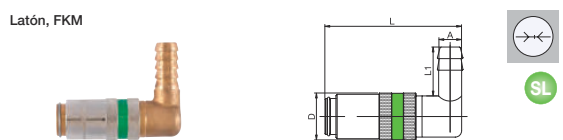

DN	Serie	A	L	L1	D	
6	10	9	10KFTR09MVXSL	53,5	22	18
9	11	13	11KFTR13MVXSL	63,5	28,5	24

10/11KFTF Enchufe sin válvula, conexión manguera, Cierre de seguridad

Latón, FKM

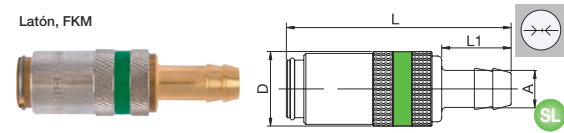

DN	Serie	A	L	L1	D	
6	10	9	10KFTF09MVXSL	60	22	18
9	11	13	11KFTF13MVXSL	71	25	24

10/11KFTH Enchufe sin válvula, conexión manguera a 45°, Cierre de seguridad

Latón, FKM

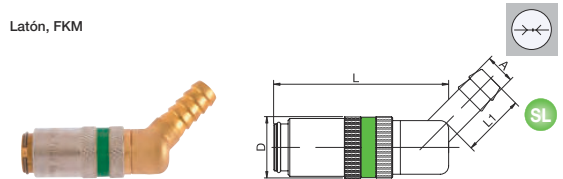

DN	Serie	A	L	L1	D	
6	10	9	10KFTH09MVXSL	60	22	18
9	11	13	11KFTH13MVXSL	60,5	25	24

Series 10/11 - Tecnología de cierre seguro

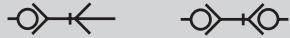

Simple obturación/Doble obturación

10/11KBA Enchufe con válvula, rosca macho, Cierre de seguridad

Latón, FKM

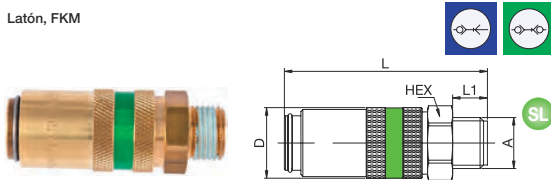

DN	Serie	A		HEX	L	L1	D
6	10	G1/4	10KBAW13MVXSL	17	52,5	9	18
		M14 x 1,5	10KBAM14MVXSL	17	52,5	9	18
		G3/8	10KBAW17MVXSL	19	52,5	9	18
9	11	G1/4	11KBAW13MVXSL	22	62	9	24
		M16 x 1,5	11KBAM16MVXSL	22	62	9	24
		G3/8	11KBAW17MVXSL	22	62	9	24
		G1/2	11KBAW21MVXSL	22	65	12	24

10/11KBTf Enchufe con válvula, conexión manguera, Cierre de seguridad

Latón, FKM

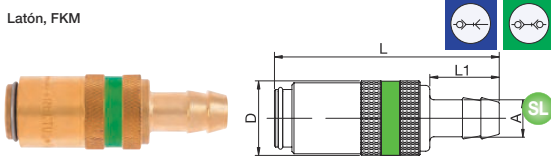

DN	Serie	A		L	L1	D
6	10	9	10KBTf09MVXSL	60	22	18
9	11	13	11KBTf13MVXSL	71	25	24

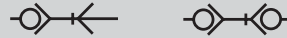

Simple obturación/Doble obturación

10/11KBTR Enchufe con válvula, conexión manguera a 90°, Cierre de seguridad

Latón, FKM

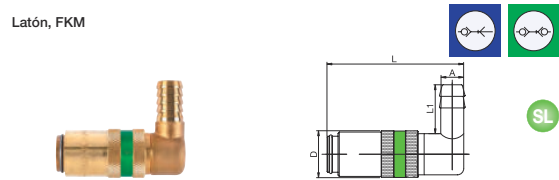

DN	Serie	A		L	L1	D
6	10	9	10KBTR09MVXSL	53,5	22	18
9	11	13	11KBTR13MVXSL	63,5	28,5	24

10/11KBTH Enchufe con válvula, conexión manguera a 45°, Cierre de seguridad

Latón, FKM

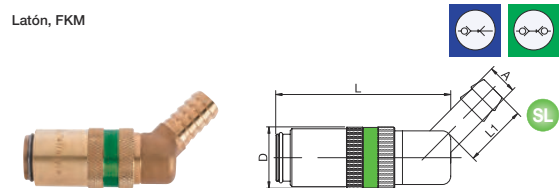

DN	Serie	A		L	L1	D
6	10	9	10KBTH09MVXSL	60	22	18
9	11	13	11KBTH13MVXSL	60,5	25	24

Serie 10/11 - Tecnología de cierre seguro

Diámetro nominal
6/9



SV

Las series de acoplamientos Rectus Moldtite 10 y 11 con cierre de seguridad se desarrollaron especialmente para conectar líneas de refrigerante y moldes de inyección. Se destacan por su cómodo funcionamiento con una sola mano y por su fiable junta tórica. Ampliamente utilizados en Europa. Sistema de enchufe automático con cierre de seguridad. El desacoplamiento accidental se previene de forma eficaz y fácil con el bloqueo de seguridad automático.

- Disponible en:
 - versiones de simple obturación, de doble obturación o de paso directo
- Los acoplamientos rectos están equipados con manguitos niquelados para una rápida y precisa diferenciación visual
- Las conexiones angulares evitan que se formen pliegues en la manguera
- Disponible a petición:
 - Las series 10/11 también están disponibles con una junta especial de alta temperatura de FFKM para aplicaciones hasta una temperatura constante de 200°C

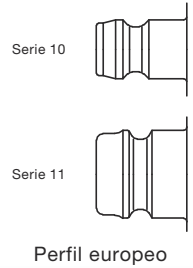

KF Sin obturación

Presión de trabajo*:
hasta 15 bar

Material:

- Enchufe: Latón
- Acoplador: Latón, acero inoxidable
- Junta: FKM

Temperatura de trabajo:
-15°C hasta +200°C (FKM)

Caudal de agua:

- Serie 10: 16 l/min.
- Serie 11: 50 l/min.

caída de presión de 0,5 bar

KA Simple obturación

Presión de trabajo*:
hasta 15 bar

Material:

- Enchufe: Latón
- Acoplador: Latón, acero inoxidable
- Junta: FKM

Temperatura de trabajo:
-15°C hasta +200°C (FKM)

Caudal de agua:

- Serie 10: 8 l/min.
- Serie 11: 20 l/min.

caída de presión de 0,5 bar

KB Doble obturación

Presión de trabajo*:
hasta 15 bar

Material:

- Enchufe: Latón
- Acoplador: Latón
- Junta: FKM

Temperatura de trabajo:
-15°C hasta +200°C (FKM)

Caudal de agua:

- Serie 10: 7 l/min.
- Serie 11: 15 l/min.

caída de presión de 0,5 bar

* máxima presión estática de trabajo con un factor de diseño de 4 a 1.

10/11KFA Enchufe sin válvula, rosca macho

Latón, FKM

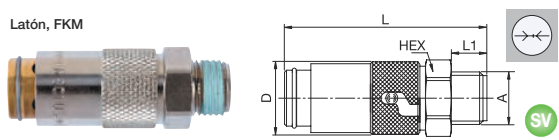

DN	Serie	A	HEX	L	L1	D
6	10	G1/4	10KFAW13MVXSV	17	51	9 18
		M14 x 1,5	10KFAW14MVXSV	17	51	9 18
		G3/8	10KFAW17MVXSV	19	51	9 18
9	11	G1/4	11KFAW13MVXSV	22	59,5	9 23
		M16 x 1,5	11KFAW16MVXSV	22	59,5	9 23
		G3/8	11KFAW17MVXSV	22	59,5	9 23
		G1/2	11KFAW21MVXSV	22	62,5	12 23

10/11KFAR Enchufe sin válvula, rosca macho 90°

Latón, FKM

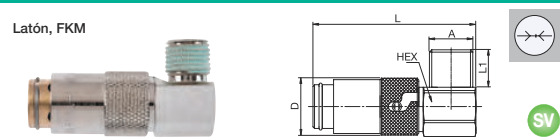

DN	Serie	A	HEX	L	L1	D
6	10	G1/4	10KFAR13MVXSV	17	52,5	12 18
		M14 x 1,5	10KFAR14MVXSV	17	52,5	12 18
		G3/8	10KFAR17MVXSV	19	52,5	12 18
9	11	M16 x 1,5	11KFAR16MVXSV	22	61,5	12 23

10/11KFAH Enchufe sin válvula, rosca macho 45°

Latón, FKM

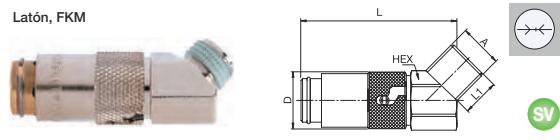

DN	Serie	A	HEX	L	L1	D
6	10	G1/4	10KFAH13MVXSV	17	52,5	9 18
		M14 x 1,5	10KFAH14MVXSV	17	52,5	9 18
		G3/8	10KFAH17MVXSV	19	52,5	9 18
9	11	M16 x 1,5	11KFAH16MVXSV	22	61,5	9 23

Series 10/11 - Tecnología de cierre seguro



Sin obturación

10/11KFTF Enchufe sin válvula, conexión manguera

Latón, FKM

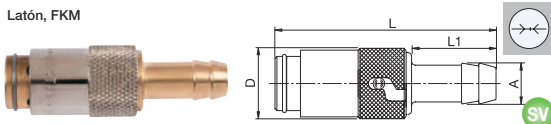

DN	Serie	A		L	L1	D
6	10	9	10KFTF09MVXSV	57,5	22	18
9	11	13	11KFTF13MVXSV	68,5	25	23

10/11KFTR Enchufe sin válvula, conexión manguera a 90°

Latón, FKM

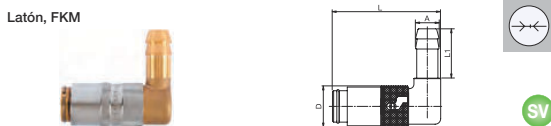

DN	Serie	A		L	L1	D
6	10	9	10KFTR09MVXSV	48,5	22	18
9	11	13	11KFTR13MVXSV	56	28	23

10/11KFTH Enchufe sin válvula, conexión manguera a 45°

Latón, FKM

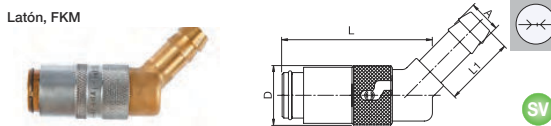

DN	Serie	A		L	L1	D
6	10	9	10KFTH09MVXSV	46,5	22	18
9	11	13	11KFTH13MVXSV	56	28	23



Simple obturación/Doble obturación

10/11KBA Enchufe con válvula, rosca macho

Latón, FKM

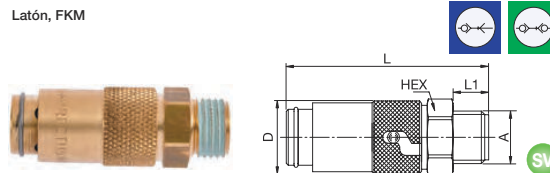

DN	Serie	A		HEX	L	L1	D
6	10	G1/4	10KBAW13MVXSV	17	51	9	18
		M14 x 1,5	10KBAW14MVXSV	17	51	9	18
		G3/8	10KBAW17MVXSV	19	51	9	18
9	11	G1/4	11KBAW13MVXSV	22	59,5	9	23
		M16 x 1,5	11KBAW16MVXSV	22	59,5	9	23
		G3/8	11KBAW17MVXSV	22	59,5	9	23
		G1/2	11KBAW21MVXSV	22	62,5	12	23

10/11KBAR Enchufe con válvula, rosca macho 90°

Latón, FKM

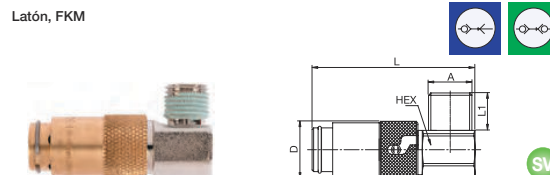

DN	Serie	A		HEX	L	L1	D
6	10	G1/4	10KBAR13MVXSV	17	52,5	12	18
		M14 x 1,5	10KBAR14MVXSV	17	52,5	12	18
9	11	M16 x 1,5	11KBAR16MVXSV	22	61,5	12	23

10/11KBAH Enchufe con válvula, rosca macho 45°

Latón, FKM

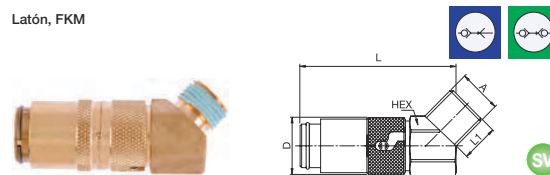

DN	Serie	A		HEX	L	L1	D
6	10	G1/4	10KBAH13MVXSV	17	52,5	9	18
		M14 x 1,5	10KBAH14MVXSV	17	52,5	9	18
9	11	M16 x 1,5	11KBAH16MVXSV	22	61,5	9	23

10/11KBTF Enchufe con válvula, conexión manguera

Latón, FKM

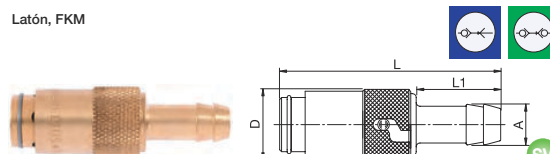

DN	Serie	A		L	L1	D
6	10	9	10KBTF09MVXSV	57,5	22	18
9	11	13	11KBTF13MVXSV	68,5	25	23

Series 10/11 - Tecnología de cierre seguro

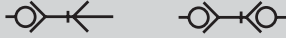

Simple obturación/Doble obturación

10/11KBTR Enchufe con válvula, conexión manguera a 90°

Latón, FKM

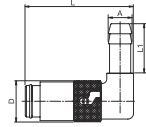

SV

DN	Serie	A		L	L1	D
6	10	9	10KBTR09MVXSV	46,5	22	18
9	11	13	11KBTR13MVXSV	56	28	23

10/11KBTH Enchufe con válvula, conexión manguera a 45°

Latón, FKM

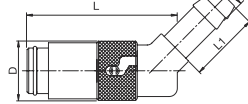

SV

DN	Serie	A		L	L1	D
6	10	9	10KBTH09MVXSV	46,5	22	18
9	11	13	11KBTH13MVXSV	56	28	23

Serie 608

Diámetro nominal
8



La serie 608 (serie francesa) ha sido especialmente desarrollada para la refrigeración en el campo de las máquinas de inyección de plástico / moldes. Utilizando insertos de enchufe verticales, la conexión de refrigeración puede ser instalada directamente en el molde / máquina, por lo que el contorno externo no tiene componentes de extensión de pre-derivación. Esto permite un manejo fácil y seguro durante el proceso de trabajo y evita daños en el enchufe automático y el molde. Este sistema se suministra como un "enchufe automático directo" sin válvulas. La codificación de las entradas y salidas puede representarse mediante la simple fijación de los clips/anillos de colores en el enchufe automático y el enchufe.

El uso de las bolas de bloqueo significa que se garantiza un agarre óptimo de la conexión del enchufe, incluso con fuerzas que se aplican lateralmente. El sencillo mecanismo de desbloqueo, que se optimiza mediante un moleteado en el extremo del manguito, puede accionarse tirando una vez del manguito.

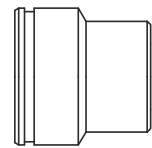

Perfil francés



Sin obturación

Presión de trabajo*:
hasta 20 bar

Material:

- Enchufe: Latón niquelado
- Acoplador: Latón niquelado
- Junta: FKM

Temperatura de trabajo:
-15°C hasta +200°C (FKM)

Caudal de agua:
32 l/min.

caída de presión de 0,5 bar

* máxima presión estática de trabajo con un factor de diseño de 4 a 1.

 Sin obturación

608KFIW Enchufe sin válvula, rosca hembra

Latón niquelado, FKM

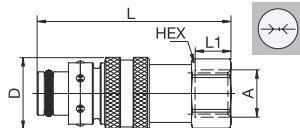

A	HEX	L	L1	D	
G1/4	608KFIW13MVN	17	54	10	20

 Sin obturación

608KFTP Enchufe sin válvula, Push-Lok

Latón niquelado, FKM

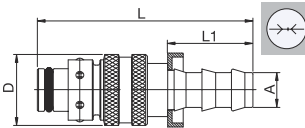

A	L	L1	D	
10	608KFTP10MVN	61	24	20
13	608KFTP13MVN	66,5	28	20

608KFTF Enchufe sin válvula, conexión manguera

Latón niquelado, FKM

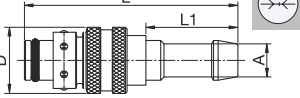

A	L	L1	D	
8	608KFTF08MVN	65	28	20
10	608KFTF10MVN	65	28	20
12	608KFTF12MVN	65	28	20

608KFTR Enchufe sin válvula, conexión manguera a 90°

Latón niquelado, FKM

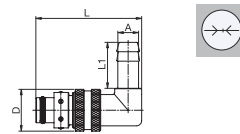

A	L	L1	D	
10	608KFTR10MVN	51	20	20
12	608KFTR12MVN	51	20	20

Serie 608

→← Sin obturación

608KFTH Enchufe sin válvula, conexión manguera a 45°

Latón niquelado, FKM

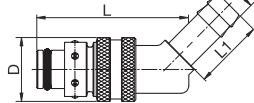

A		L	L1	D
10	608KFTH10MVN	51	20	20
12	608KFTH12MVN	51	20	20

608KFPR Enchufe sin válvula, Push-Lok 90°

Latón niquelado, FKM

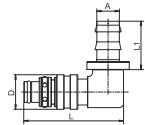

A		L	L1	D
10	608KFPR10MVN	54,5	24	20
13	608KFPR13MVN	58	28	20

608KFPH Enchufe sin válvula, Push-Lok 45°

Latón niquelado, FKM

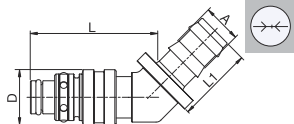

A		L	L1	D
10	608KFPH10MVN	44,5	24	20
13	608KFPH13MVN	47	28	20

→← Sin obturación

608SFA Acoplador sin válvula, rosca macho

Latón niquelado

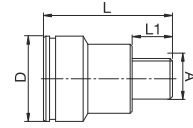

A		HEX	L	L1	L2	D
M10 x 1	608SFAM10MXN	6	32	10		21
G1/8	608SAF10MXN	6	32	10		21
G1/4	608SAF13MXN	8	33	12		21
G3/8	608SAF17MXN	8	24	13		21
R1/8	608SFAR10MXN		34	11	33	22
G1/4	608SFAR13MXN		37	13	33	22
G3/8	608SFAR17MXN		37	13	33	22
R1/8	608SFAH10MXN		33	10,5		22
R1/4	608SFAH13MXN		35	13		22

608SFIW Acoplador sin válvula, rosca hembra

Latón niquelado

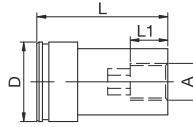

A		HEX	L	L1	D
G1/8	608SFIW10MXN	6	35	10	21
G1/4	608SFIW13MXN	8	40	14	21

608VN Acoplador de extensión, rosca macho

Latón niquelado

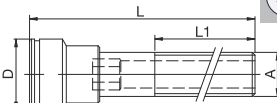

A		HEX	L	L1	D
G1/8	608VN1005MXN	6	50	28	21
G1/8	608VN1010MXN	6	100	60	21
G1/8	608VN1015MXN	6	150	60	21
G1/4	608VN1305MXN	8	50	28	21
G1/4	608VN1310MXN	8	100	60	21
G1/4	608VN1315MXN	8	150	60	21

DHX608 Clip de color para acoplamientos y enchufes

POM



A		Color
	Clip de acoplamiento DHX608KXXKXR	Rojo
	Clip de acoplamiento DHX608KXXKXB	Azul
	Clip de acoplamiento DHX608KXXKXS	Negro
	Clip de enchufe DHX608SXXKXR	Rojo
	Clip de enchufe DHX608SXXKXB	Azul
	Clip de enchufe DHX608SXXKXS	Negro

Serie 93

Diámetro nominal
8,1



Enchufe automático y enchufe integrado modular para la instalación en sistemas de enchufe automático múltiple. Alta resiliencia, bajas fuerzas de enchufe automático y gran resistencia a los medios líquidos debido al recubrimiento especial del cuerpo del enchufe automático.

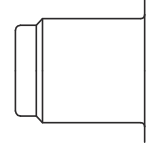

KF Sin obturación

Presión de trabajo*:
hasta 15 bar

Material:

- Enchufe: Latón niquelado, Acero tratado con PTFE
- Acoplador: Latón niquelado, Acero tratado con PTFE
- Junta: FKM

Temperatura de trabajo:
-15°C hasta +100°C (FKM)

Caudal de agua:
46 l/min.
caída de presión de 0,5 bar



KL Doble obturación sin goteo

Presión de trabajo*:
hasta 15 bar

Material:

- Enchufe: Latón niquelado, Acero tratado con PTFE
- Acoplador: Latón niquelado, Acero tratado con PTFE
- Junta: FKM

Temperatura de trabajo:
-15°C hasta +100°C (FKM)

Caudal de agua:
20 l/min.
caída de presión de 0,5 bar

* máxima presión estática de trabajo con un factor de diseño de 4 a 1.



Sin obturación



Sin goteo

93KFIW Enchufe sin válvula, rosca hembra

Latón niquelado, acero recubierto de PTFE, FKM

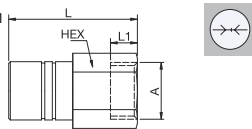

DN	A	HEX	L	L1
8,1	G1/2	93KFIW21SVN	24	48 12

93KLIW Enchufe con válvula, rosca hembra

Latón niquelado, acero recubierto de PTFE, FKM

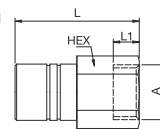

DN	A	HEX	L	L1
8,1	G1/2	93KLIW21SVN	24	48 12

93SFIW Acoplador sin válvula, rosca hembra

Latón niquelado, acero recubierto de PTFE

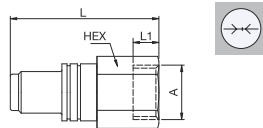

DN	A	HEX	L	L1
8,1	G1/2	93SFIW21SXN	24	57,5 12

93SLIW Acoplador con válvula, rosca hembra

Latón niquelado, acero recubierto de PTFE, FKM

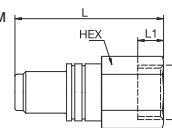

DN	A	HEX	L	L1
8,1	G1/2	93SLIW21SVN	24	57,5 12

Serie 93

94KX Enchufe de bloqueo

Acero niquelado

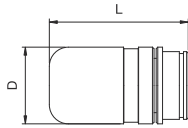

L D

94KX

45 25

94SX Perno de bloqueo

Acero niquelado

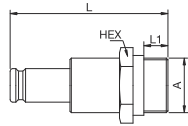

HEX L L1

94SX

24 58 13

Accesorios

QH Férrulas

Acero inoxidable

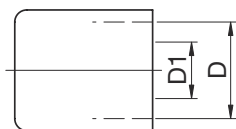

D D1

QH1510	15	11,5
QH1610	17	11,5
QH1810	18,5	13,7
QH1913	19	14,2
QH2013	20,5	14,5
QH2213	21,7	15
QH2313	23,5	17,5
QH2919	28,5	22

PM Crimper



D

PM10-36	10-36
---------	-------

MHE mangueras de EPDM

EPDM

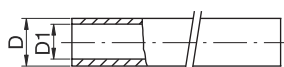

Referen-
cia
forros

Longitud máxima en m

D D1 Color

MHE1050B	50	QH1610	16,5	9,5	Azul
MHE1050R	50	QH1610	16,5	9,5	Rojo
MHE1050S	50	QH1610	16,5	9,5	Negro
MHE1350B	50	QH2313	21,5	12,7	Azul
MHE1350R	50	QH2313	21,5	12,7	Rojo
MHE1350S	50	QH2313	21,5	12,7	Negro
MHE1930B	30	QH2919	27	19	Azul
MHE1930R	30	QH2919	27	19	Rojo
MHE1930S	30	QH2919	27	19	Negro

Fluido compatible: Agua, hasta 20 bar, hasta +140°C

MHN mangueras NBR

NBR



Referen-
cia
forros

Longitud máxima en m

D D1 Color

MHN1050S	50	QH1610	15,9	9,5	Negro
MHN1350S	50	QH2213	19,8	12,7	Negro

Fluido compatible: aceite, hasta 28 bar, hasta +135°C

mangueras

MHP mangueras de PVC

PVC

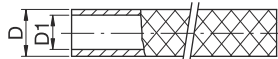

	Longitud máxima en m	Referencia forros	D	D1	Color
MHP1030T	30	QH1610	16	10	Transparente
MHP1030B	30	QH1610	16	10	Azul
MHP1030R	30	QH1610	16	10	Rojo
MHP1330T	30	QH1913	19	13	Transparente
MHP1330B	30	QH1913	19	13	Azul
MHP1330R	30	QH1913	19	13	Rojo
MHP1930T	50	QH2919	27	19	Transparente

Fluido compatible: Agua, hasta 15 bar, hasta +60°C

MHS mangueras de silicona

Silicona



	Longitud máxima en m	Referencia forros	D	D1	Color
MHS1025	25	QH1510	14	9,5	GRIS
MHS1025B	25	QH1510	14	9,5	Azul
MHS1025R	25	QH1510	14	9,5	Rojo
MHS1325	25	QH1913	17,5	13	GRIS
MHS1325B	25	QH1913	17,5	13	Azul
MHS1325R	25	QH1913	17,5	13	Rojo

Fluido compatible: Agua, hasta 25 bar, hasta +170°C

MHF mangueras FKM

FKM



	Longitud máxima en m	Referencia forros	D	D1	Color
MHF1025	25	QH1510	23	16	GRIS
MHF1325	25	QH1913	26	19	GRIS

Fluido compatible: Aceite/agua, hasta 15 bar, hasta +130°C

Serie Midi

Diámetro nominal
12



La serie Midi está adaptada para aplicaciones de agua y aire comprimido. La amplia gama de enchufes permite muchas combinaciones para los usuarios finales.

- Diseñado para la transmisión de agua y fluidos
- Capacidades de alto caudal
- Máxima eficiencia energética

propio perfil



Simple obturación

Presión de trabajo*:
hasta 20 bar

Material:

- Enchufe: Latón niquelado
- Acoplador: Latón niquelado
- Junta: NBR

Temperatura de trabajo:
-20°C hasta +100°C (NBR)

Caudal de aire:
2 200 NI/min.

presión de entrada 6 bar, caída de presión 0,6 bar



Simple obturación



Sin obturación

0172 Enchufe con válvula, rosca hembra BSPP

Latón niquelado, NBR



DN	C	E	F	G	L
12	G3/8	0172 12 17	16	27	29 56
	G1/2	0172 12 21	16	27	29 56

Serie Midi: simple obturación= 2200NI/min

2272 Enchufe con válvula, rosca hembra BSPP

Latón niquelado, NBR



DN	C	E	F	G	L
12	G1/2	2272 12 21	10	24	29 33
	G3/4	2272 12 27	10	30	29 34,5
	G1	2272 12 34	10	36	29 34,5

Serie Midi



Simple obturación

2511 Enchufe con válvula, con espiga acanalada para tubo flexible

Latón niquelado, NBR

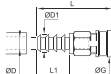

DN	ØD	ØD1		G	L	L1
12	13,5	2511 12 12		29	75	32
12	15	16,5	2511 12 15	29	75	32
12	19	20,5	2511 12 19	29	81	38

Serie Midi: simple obturación = 2200NI/min



Sin obturación

2296 Acoplador sin válvula, rosca hembra BSPP

Latón niquelado



DN	C		E	G	L
12	G1/2	2296 12 21	11	24	31,5
12	G3/4	2296 12 27	11	30	38
12	G1	2296 12 34	11	36	36,5

Sin obturación



Sin obturación

2297 Enchufe sin válvula, con espiga acanalada para tubo flexible

Latón niquelado, NBR



DN	ØD	ØD1		G	L	L1
12	13,5	2297 12 12		29	51	27
12	15	16,5	2297 12 15	29	51	27
12	19	20,5	2297 12 19	29	57	33

0195 Acoplador sin válvula, con espiga acanalada para tubo flexible

Latón niquelado

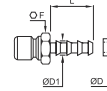

DN	ØD	ØD1		F	L
12	7	9	0195 07 00	17	29,5
12	10	12,2	0195 10 00	17	29,5
12	13	15,2	0195 13 00	17	29,5
12	16	18,5	0195 16 00	21	36,5

Sin obturación

2294 Acoplador sin válvula, rosca BSPP macho

Latón niquelado

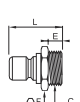

DN	C		E	F	L
12	G3/8	2294 12 17	6	22	31,5
12	G1/2	2294 12 21	9,5	22	37
12	G3/4	2294 12 27	13,5	27	41
12	G1	2294 12 34	10,5	34	36

Sin obturación

2295 Acoplador sin válvula, con espiga acanalada para manguera flexible

Latón niquelado

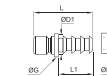

DN	ØD	ØD1		G	L	L1
12	12	13,5	2295 12 12	17	48	27
12	15	16,5	2295 12 15	18	48	27
12	19	20,5	2295 12 19	24	57	33

Sin obturación

0196 Acoplador sin válvula, rosca hembra BSPP

Latón niquelado

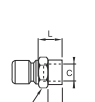

DN	C		E	F	L
12	G1/4	0196 12 13	12	17	16
12	G3/8	0196 12 17	12	21	15
12	G1/2	0196 12 21	14	26	17

Sin obturación

2293 Enchufes Y, sin obturación

Latón niquelado, NBR

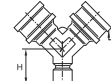

DN		G	H
12	2293 12 00	29	27

Sin obturación

Serie Midi: directo = 2200 NI/min

Serie Midi

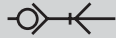

Sin obturación

2270 Enchufe sin válvula, con grifo, rosca macho BSPP

Latón niquelado, NBR

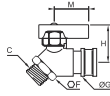

DN	C	F	G	H
12	G1/2	2270 21 00	28	29 40,5

Caudal = 2200 NI/min

2292 Enchufe adaptador universal

Latón niquelado, NBR



DN	G	L
12	2292 12 00	29 40,5

Sin obturación

Este adaptador proporciona intercambiabilidad con numerosos componentes (especialmente los accesorios de riego).

2398 Acoplador adaptador universal

Latón niquelado, NBR

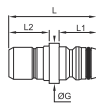

DN	G	L	L1	L2
12	2398 12 01	20	43	19 18,5

Este adaptador proporciona intercambiabilidad con numerosos componentes (especialmente accesorios de riego).

2299 Pistola para riego

Zamak, Latón niquelado, NBR

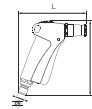

DN	H	L	Kg
12	2299 12 01	140	126 0,470

Esta pistola permite regular de manera independiente:

- la fuerza del chorro (caudal) gracias a su empuñadura
 - la forma del chorro (hasta la atomización fina) por la boquilla de su manguera zamac, latón niquelado, NBR
- Pistola compatible con los acoplamientos de la serie midi página 381.

2299 manguera de riego

Latón niquelado, NBR



DN	L	Kg
12	2299 12 20	77,4 0,137

La forma del chorro de pulverización de esta manguera es regulable.

Serie Maxi

Diámetro nominal
19



La robusta serie maxi está diseñada para aplicaciones de alto caudal y asegura el manejo de agua y aire comprimido.

- Diseñado para la transmisión de agua y fluidos
- Capacidades de caudal muy altas
- Ideal para aplicaciones de lavado...

propio perfil



Presión de trabajo*:
hasta 20 bar

Material:

- Enchufe: Latón niquelado
- Acoplador: Latón niquelado
- Junta: NBR

Temperatura de trabajo:
-20°C hasta +100°C (NBR)

Caudal de aire:
8 500 NI/min.

presión de entrada 6 bar, caída de presión 0,6 bar

 Sin obturación

2272 Enchufe sin válvula, rosca hembra BSPP

Latón niquelado, NBR

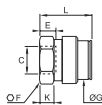

DN	C	E	F	G	K	L
19	G1	2272 18 34	9	36	42	11 45

Maxi-serie: recto = 8500 NI/min

 Sin obturación

2294 Acoplador sin válvula, rosca BSPP macho

Latón niquelado

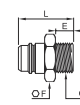

DN	C	E	F	L
19	G3/4	2294 18 27	10,5	27 42,5
19	G1	2294 18 34	13	34 46

Sin obturación

2297 Enchufe sin válvula, con espiga acanalada para manguera Flexible

Latón niquelado, NBR

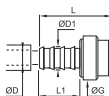

DN	ØD	ØD1	G	L	L1
19	19	20,7	2297 18 20	39,5	69 37

Maxi-serie: recto = 8500 NI/min

2295 Acoplador sin válvula, con espiga acanalada para manguera flexible

Latón niquelado



DN	ØD	ØD1	L	L1
19	19	21	2295 18 20	69 41

Sin obturación

Notas

#03

TUBOS Y PISTOLAS

Tubos flexibles calibrados

Multi-tubos calibrados

Tubos en espiral calibrados

Tubos trenzados calibrados

Accesorios

Pistolas



Cómo elegir sus tubos y mangueras?

Puntos clave a considerar antes de elegir sus tubos y mangueras

¿Cuál es la diferencia entre Tubo y Manguera?

- **Tubo:** El agarre y el sellado están en el O.D. del tubo calibrado. El diámetro completo para un flujo óptimo.
- **Mangueras:** El agarre y el sellado están en la identificación de la manguera. La conexión y el sellado se logran a través de la distorsión de la manguera.

¿Cuáles son las condiciones de uso?

- Presión
- La temperatura dentro del sistema
- Tipo de fluido transportado
- Exposición a los rayos U.V.



¿Ha pensado en requisitos adicionales?

- Racores instantáneos
- Racores de compresión
- Racores de cánula
- Pistolas
- Acoplamientos
- Adaptadores de la pieza de la cola









¿Qué tipo de embalaje necesita?

- Dependiendo de la longitud:
- Tubepack® (5 a 100 m)
 - Tambor (40 a 1000 m)
 - Rollos (25 a 50 m)







¿Tiene requisitos de cumplimiento?

- RoHS
- PED
- REACH
- UL94
- 1935/2004/CE
- FDA

Descripción de las especificaciones del producto

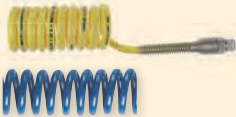
	Materiales	Fluidos	Presión máxima (bar)	Temperaturas		Resistencia en entornos agresivos		Pagina
				Min.	Max.	Mecánica	Química	
PA semi-rígida 	Poliamida semirrígida	Aire comprimido, fluidos industriales	50	-40°C	+100°C	Buena	Buena	394
PA rígida 	Poliamida rígida	Aire comprimido, fluidos industriales	58	-40°C	+80°C	Buena	Buena	395
PA ignífuga de alta resistencia - fuego y humo 	Poliamida con aditivo ignífugo	Líquidos de refrigeración, fluidos industriales (lubricante), Aire comprimido	50	-50°C	+100°C	Excelente	Moderada	396
PA y PU anti-chispas 	Poliamida semirrígida con funda de PVC Poliuretano éter con funda de PVC Poliuretano éter monocapa con aditivo ignífugo	Aire comprimido, Líquidos de refrigeración, fluidos industriales	36 (PA) 14 (PU)		+80°C -20°C	Excelente	Buena	397
PU 	Poliuretano poliéster Poliuretano poliéster Poliuretano poliéster «cristal» de calidad alimentaria	Aire comprimido, fluidos industriales (agua) o fluidos agroalimentarios	12	-20°C	+70°C	Excelente	Moderada Buena Buena	398
Anti-estático 	Poliuretano cargado de partículas conductoras	Aire comprimido	10	-20°C	+70°C	Excelente	Moderada	400
PE Avanzado 	Poliétileno avanzado	Bebidas, agua	16	-40°C	+95°C	Buena	Excelente	403
FEP 	Fluoropolímero: etileno propileno fluorado	Todos los fluidos	28	-40°C	+150°C	Buena	Excelente	405
PFA 	Fluoropolímero: Perfluoroalcoxi de alta pureza y coloreado FDA	Todos los fluidos	36	-40°C	+150°C	Excelente	Buena	406

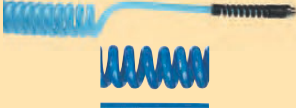
Tubos técnicos

	Materiales	Fluidos	Presión máxima (bar)	Temperaturas		Resistencia en entornos agresivos		Pagina
				Min.	Max.	Mecánica	Química	
PFA anti-estático 	Fluoropolímero: Perfluoroalcoxi cargado de partículas conductoras	Todos los fluidos	36	-40°C	+150°C	Excelente	Buena	406
Multi-tubo 	Poliamida Poliuretano	Aire comprimido, fluidos químicos y industriales Aire comprimido, fluidos industriales	24 14	-40°C -20°C	+80°C +70°C	Buena	Buena	407
Tubo de Recolección de PA - RECTULÁSTICO 	Poliamida	Aire comprimido, lubricantes	20 16	-20°C -40°C	+80°C +90°C	Buena	Buena	408
Tubo de Recolección de PU - RECTUFLEX 	Poliuretano	Aire comprimido	10 11	-20°C -40°C	+70°C +75 °C	Excelente	Buena	412
Manguera trenzada de PVC - RECTUSOFT 	- PVC de grado alimenticio - PVC de grado industrial - RECTUSOFT: 3 capas de PVC	Aire comprimido	15	-20°C -25°C -15°C	+70°C +60°C +60°C	Excelente	Buena	415
Auto-retráctil NBR 	NBR con trenza de poliamida	Aire comprimido, fluidos de refrigeración	16	-20°C	+100°C	Excelente	Buena	417
Manguera trenzada de poliuretano - SUPERBRAID 	Poliuretano	Aire comprimido	15	-40°C	+75°C	Excelente	Buena	419
Trenzado interior de PU ULTRALITE SUPERBRAID 	Poliuretano reforzado con poliéster Dacron	Aire comprimido	12	-40°C	+75°C	Excelente	Buena	419
Accesorios para los tubos 	Compuesto Latón Acero inoxidable	Aire comprimido fluidos industriales						421

Embalaje de los tubos técnicos

Tubepack®

- Longitudes de 5 m, 10 m, 25 m y 100 m
- Para tubos poliamida, de poliuretano, fluoropolímero, polietileno y anti-chispas
- Optimización del almacenamiento de los tubos
- Identificación inmediata del tipo de tubo
- Devanadera integrada para una manipulación sencilla



5 m - 100 m

Tambor

- Hasta 1000 m
- Para tubos poliamida, de poliuretano, fluoropolímero, etc.
- Identificación inmediata del tubo para una manipulación sencilla
- Adaptado a los carretes de taller



40 m - 1000 m

Rollos

- Hasta 50 m
- Suministrada con una película protectora de plástico
- Para los tubos trenzados y los tubos especiales (Multi-tubos)



25 m - 50 m

Bolsas de presentación

- Ideal para la venta en autoservicio
- Herramientas de promoción
- Tubo en espiral o tubo cortado a medida



Marcado de los tubos

- Una marca de la longitud se indica cada metro:
 - ahorro de tiempo para cortar la longitud
 - cantidad restante identificable inmediatamente (PA y PU)
- Marcado personalizado posible bajo demanda (marca, identificación del fluido, referencia del cliente...)
- Trazabilidad identificada mediante el marcado del número de lote de fabricación

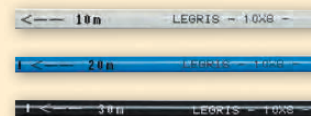

Gráficos de características

- En los gráficos de este capítulo, cada una de las curvas indica, por diámetro, la presión máxima admisible a una temperatura dada.
- Las características técnicas de los tubos Parker Legris dependen del tipo de racor utilizado.
- La retención de vacío de los tubos es de 755 mm Hg (99% vacío).

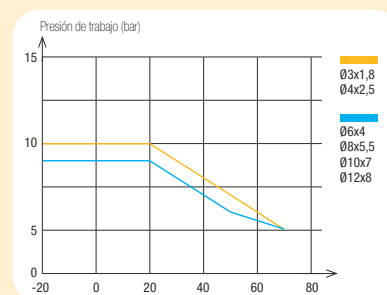

Codificación de tubos técnicos

Material

- H** = Auto-retráctil NBR
- L** = Poliamida rígida
- P** = Poliamida semi-rígida
- T** = Fluoropolimero
- U** = Poliuretano
- V** = PVC
- Y** = Polietileno

Tipo de Tubo

- P..A** = PA anti-estático
- P..R** = PA ignífuga (fuego y humo)
- P..V** = PA anti-chispas, con funda de PVC
- T..A** = PFA anti-estático
- T..P** = PFA
- U..A** = PU anti-estático
- U..K** = PU monocapa y anti-chispas
- U..R** = PU poliéter
- U..V** = PU anti-chispas, con funda de PVC
- Y..F** = PE Advanced (LIQUfit®)

2 010 P 04 R 00 27

Código Embalaje	Longitud	Código Ø ext.	Color	Ø int. especial
1 = Tubepack® o tambor LIQUfit®	015 = 150 m	03 = 3 mm	00 = ◯ incoloro	18 = 1,8 mm
	020 = 20 m	04 = 4 mm	01 = ● negro	27 = 2,7 mm
	025 = 25 m	06 = 6 mm	02 = ● verde	33 = 3,3 mm
	030 = 300 m	08 = 8 mm	03 = ● rojo	75 = 7,5 mm
	040 = 40 m	.../...	04 = ● azul	95 = 9,5 mm
	075 = 75 m		05 = ● amarillo	
	080 = 80 m	56 mm = 1/4"	06 = ● gris	
	100 = 100 m	.../...	07 = ● naranja	
			08 = ◯ incoloro cristal	
			09 = ● violeta	
2 = Tambor para grandes longitudes	003 = 300 m	10 = 10 mm	10 = ◯ blanco	
	005 = 500 m	04 = 4 mm	12 = ● verde cristal	
		06 = 6 mm	13 = ● rojo cristal	
		08 = 8 mm	14 = ● azul cristal	
		10 = 10 mm	17 = ● naranja cristal	
	010 = 1000 m	04 = 4 mm		
		06 = 6 mm		



Tubo PA



El tubo de PA está disponible en 2 grados: semirrígido con una oferta probada y duradera gracias a sus propiedades mecánicas, rígido con una oferta de alto rendimiento basada en el enfoque del Ecodiseño.

Ø métrico:
3 a 16 mm

Características técnicas

Tubo	PA semi-rígida	PA rígida
Líquidos compatibles	Aire comprimido, otros fluidos	Aire comprimido, lubricantes, otros fluidos
Presión de trabajo	De vacío hasta 50 bar	De vacío hasta 58 bar
Temperatura de trabajo	-40°C a +100°C	-40°C a +80°C
Materiales componentes	Poliamida de origen ecológico (68 shore D)	Poliamida (65 shore D)

Las prestaciones dependen de los fluidos y de los racores utilizados. El uso está garantizado para un vacío de 755 mm Hg (99% de vacío).

Reglamentaciones

- Industriales:
- RoHS
 - PED
 - REACH
- Transporte:
- Prestaciones y resistencias químicas probadas según DIN 74324

Ventajas

- Estabilidad química
- La marca en el tubo de la longitud restante
- Un gran panel de color para la identificación de los circuitos

Rendimiento de los tubos de PA

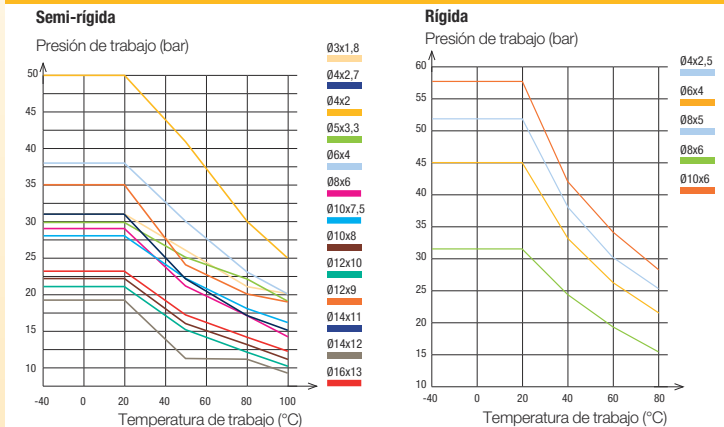

Ø exterior del tubo	Tolerancias sobre Ø exterior
3 a 5 mm	+0,05 / -0,08
6 a 16 mm	+0,05 / -0,10

Conectados a los racores instantáneos Parker Legris, los tubos Parker Legris garantizan al usuario una perfecta estanqueidad gracias a su calibrado según la norma NF E49-100.

1025P Tubo poliamida (PA) semi-rígido

Tubepack® 25 m















ØD ext.	ØD int.	R	incoloro								Kg
3	1,8	6	1025P03 00 18					1025P03 04 18			0,200
	2	10	1025P04 00	1025P04 01	1025P04 02	1025P04 03	1025P04 04	1025P04 05			0,318
4	2,7	10	1025P04 00 27	1025P04 01 27	1025P04 02 27	1025P04 03 27	1025P04 04 27	1025P04 05 27	1025P04 06 27		0,354
5	3,3	15	1025P05 00 33	1025P05 01 33			1025P05 04 33				0,420
6	4	15	1025P06 00	1025P06 01	1025P06 02	1025P06 03	1025P06 04	1025P06 05	1025P06 06		0,540
8	6	25	1025P08 00	1025P08 01	1025P08 02	1025P08 03	1025P08 04	1025P08 05	1025P08 06		0,790
	7,5	42	1025P10 00 75	1025P10 01 75			1025P10 04 75				1,135
10	8	50	1025P10 00	1025P10 01	1025P10 02	1025P10 03	1025P10 04	1025P10 05	1025P10 06		0,980
	9	47	1025P12 00 09	1025P12 01 09			1025P12 04 09				1,345
12	10	90	1025P12 00	1025P12 01			1025P12 04	1025P12 05			1,769
	11	80	1025P14 00 11	1025P14 01 11			1025P14 04 11				1,960
14	12	116	1025P14 00	1025P14 01			1025P14 04				2,226
16	13	90	1025P16 00 13	1025P16 01 13	1025P16 02 13	1025P16 03 13	1025P16 04 13				2,500

Tubos en pulgadas disponibles bajo demanda

Tubo PA

1100P Tubo poliamida (PA) semi-rígido





Tubepack® 100 m

ØD ext.	ØD int.									Kg	
4	2	10		1100P04 00	1100P04 01	1100P04 02	1100P04 03	1100P04 04	1100P04 05	1100P04 06	0,893
	2,7	10		1100P04 00 27	1100P04 01 27	1100P04 02 27	1100P04 03 27	1100P04 04 27	1100P04 05 27	1100P04 06 27	1,152
5	3,3	15		1100P05 00 33						1,274	
6	4	15		1100P06 00	1100P06 01	1100P06 02	1100P06 03	1100P06 04	1100P06 05	1100P06 06	1,799
8	6	25		1100P08 00	1100P08 01	1100P08 02	1100P08 03	1100P08 04	1100P08 05	1100P08 06	2,560
10	7,5	42		1100P10 00 75	1100P10 01 75			1100P10 04 75			3,430
	8	50		1100P10 00	1100P10 01	1100P10 02	1100P10 03	1100P10 04	1100P10 05		4,000
12	9	47		1100P12 00 09	1100P12 01 09			1100P12 04 09			5,052
	10	90		1100P12 00	1100P12 01			1100P12 04		1100P12 06	5,600
14	11	80		1100P14 00 11	1100P14 01 11			1100P14 04 11			4,800
	12	116		1100P14 00	1100P14 01			1100P14 04			5,200
16	13	90		1100P16 00 13	1100P16 01 13			1100P16 04 13			6,613

Tubos en pulgadas disponibles bajo demanda





2005P Tubo poliamida (PA) semi-rígido

Tambor 500 m

ØD ext.	ØD int.								Kg	
8	6	25		2005P08 00	2005P08 01	2005P08 02	2005P08 03	2005P08 04	2005P08 05	12,100
10	8	50		2005P10 00	2005P10 01	2005P10 02	2005P10 03	2005P10 04	2005P10 05	15,600







2010P Tubo poliamida (PA) semi-rígido

Tambor 1000 m

ØD ext.	ØD int.								Kg	
4	2,7	10		2010P04 00 27	2010P04 01 27	2010P04 02 27	2010P04 03 27	2010P04 04 27	2010P04 05 27	7,630
6	4	15		2010P06 00	2010P06 01	2010P06 02	2010P06 03	2010P06 04	2010P06 05	16,600

1025L Tubo poliamida (PA) rígido

Tubepack® 25 m

ØD ext.	ØD int.									Kg
4	2,5	35		1025L04 01 25						0,192
6	4	45		1025L06 01						0,506
8	5	70		1025L08 01 05						1,040
	6	65		1025L08 01						0,777
10	6	85		1025L10 01 06						1,248

Los tubos de poliamida permiten la conexión a diversos racores presentados en este catálogo.

Tubos
PA semi-rígida

PA rígida

Racores instantáneos
LF 3000®

LF 3600

LF 3800

LF 6100

Racores de compresión
Latón

Acero inoxidable

Forros

Tubo PA ignífuga de alta resistencia



El tubo de PA de alta resistencia al fuego está diseñado para resistir el fuego y reducir la propagación de los gases tóxicos. Está diseñado para aplicaciones empotradas o industriales exigentes, sin comprometer el rendimiento de la presión y la temperatura de un tubo de PA.

Ø métrico:
4 a 12 mm

Características técnicas

- **Fluidos adecuados:** Aire comprimido, lubricantes
Otros fluidos: consúltenos
- **Presión de trabajo:** De vacío hasta 50 bar
- **Temperatura de trabajo:** -40°C a +100°C
- **Materiales:** Poliamida (63 shore D)

Las prestaciones dependen de los fluidos y de los racores utilizados. El uso está garantizado para un vacío de 755 mm Hg (99% de vacío).

Reglamentaciones

- Ferrovias:
- EN 45545-2
- Industriales:
- PED
 - RoHS
 - REACH
 - UL94-V0 (Resistencia al fuego)

Actuación

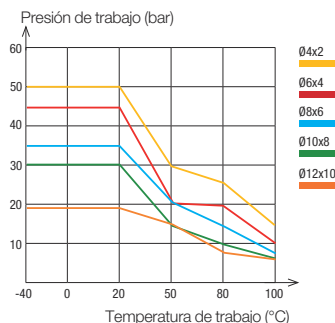

Para calcular las presiones de estallido, los valores de esta tabla se deben multiplicar por 3.

Ventajas

- Resistente a los rayos UV, a la alta presión y a la alta temperatura
- Resistente a las chispas y llamas: auto-extinguible
- Gases de combustión no tóxicos, baja generación de humo
- Alternativa a los tubos de PA recubiertos de PVC: sin herramientas para pelar, sin riesgo de dañar el tubo

Ø exterior del tubo	Tolerancias sobre Ø exterior
4 mm	+0,05 / -0,08
6 a 12 mm	+0,05 / -0,10

Embalaje
Tubepack®: 100 m

Conectados a los racores instantáneos Parker Legris, los tubos garantizan al usuario una perfecta estanqueidad gracias a su calibrado según la norma NF E49-100.

1100P..R Tubo poliamida (PA) ignífugo de alta resistencia

Tubepack® 100 m

ØD ext.	ØD int.	R	blanco			Kg
4	2	17	1100P04R00	1100P04R01	1100P04R04	1,308
6	4	29	1100P06R00	1100P06R01	1100P06R04	1,308
8	6	40	1100P08R00	1100P08R01	1100P08R04	2,384
10	8	77	1100P10R00	1100P10R01	1100P10R04	2,725
12	10	92	1100P12R00	1100P12R01		3,716

Otros colores disponibles por encargo con un mínimo de pedido: para los diámetros de 4 a 6 mm, 1000 m; para el diámetro de 8 mm, 500 m; para los diámetros de 10 a 12 mm: 300 m. Las restricciones de extrusión dan un aspecto de antracita al tubo pero no afecta en absoluto al rendimiento.

Productos asociados

El tubo de poliamida ignífuga de alta resistencia permite la conexión a diversos racores presentados en el capítulo de accesorios.

Racores instantáneos

LF 3000® LF 3600 LF 3800



LF 6100



Racores de compresión

Latón Forro latón



Tubo PA anti-chispas con funda de PVC



El tubo antichispas de PA con revestimiento de PVC está diseñado para resistir las llamas y las chispas, proporcionando un rendimiento superior contra el impacto y la abrasión. Es especialmente adecuado para equipos en un entorno sometido a salpicaduras de soldadura.

Ø métrico:
6 a 10 mm

Características técnicas

- **Fluidos adecuados:** Agua caliente / fría, líquidos refrigerantes, aire comprimido
- **Presión de trabajo:** 0 a 36 bar
- **Temperatura de trabajo:** -20°C a +80°C
- **Materiales:** Poliamida y funda de PVC

Las prestaciones dependen de los fluidos y de los racores utilizados.

Actuación

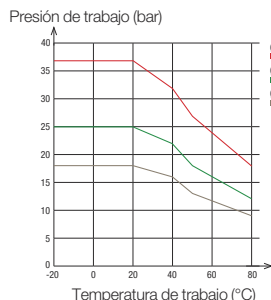

Para calcular las presiones de estallido, los valores de esta tabla se deben multiplicar por 3.

Reglamentaciones

Industriales:

- RoHS
- PED
- REACH
- UL94 (Resistencia al fuego)

Ventajas

- Capa de PVC retardante de la llama que protege el tubo interno de PA
- Fácil de quitar: la capa de PVC no se adhiere al tubo de PA
- Resistente a la alta presión/temperatura, a la torsión y al aplastamiento
- Compatibilidad con los líquidos de refrigeración

Ø exterior	Tolerancias sobre Ø exterior	Espesor de la funda de PVC	Ø exterior del tubo	Longitudes de pelado para los racores LF 3600 (mm)
Funda de PVC 8 a 12 mm	+0,10 / -0,10	1 mm	6 mm	18± 1
Tubo interior 6 a 10 mm	+0,05 / -0,10		8 mm	19± 1
			10 mm	24± 1

Conectados a los racores instantáneos Parker Legris, los tubos PA garantizan al usuario una perfecta estanqueidad gracias a su calibrado según la norma NF E49-100 (tubo interior de PA semi-rígida).

Para otras gamas, rogamos consulten con nosotros.

1025P..V Tubo poliamida (PA) anti-chispas

Tubepack® 25 m

ØD ext.	ØD int.	R	Color	Modelo	Kg
6	4	25	Rojo	1025P06V01	1,238
8	6	30	Rojo	1025P08V01	1,704
10	8	55	Rojo	1025P10V01	2,029

Los tubos de color rojo están disponibles a pedido con una cantidad mínima de pedido.

1100P..V Tubo poliamida (PA) anti-chispas

Tubepack® 100 m

ØD ext.	ØD int.	R	Color	Modelo	Kg
6	4	25	Verde	1100P06V02	2,338
8	6	30	Verde	1100P08V01	3,767
10	8	55	Verde	1100P10V01	4,767

Los tubos de color rojo están disponibles a pedido con una cantidad mínima de pedido.

6000 71 00 Útil de desenfundado

Polímero técnico, acero inoxidable



Kg

6000 71 00

0,098

Tubo PU



El tubo PU está disponible en 3 grados específicos (Poliéter, poliéster y poliéter cristal). Flexible con un pequeño radio de curvatura, ahorra el 50% del espacio para las redes, comparado con el PA semirrígido.

Ø métrico:
3 a 16 mm

Características técnicas

- **Fluidos adecuados:** Aire comprimido, fluidos industriales (según el tipo de material)
- **Presión de trabajo:** De vacío hasta 12 bar
- **Temperatura de trabajo:** -20°C a +70°C
- **Materiales:**
 - Poliuretano poliéster (52 Shore D)
 - Poliuretano poliéter (52 Shore D)
 - Poliuretano poliéter "cristal" alimentario (52 Shore D)

Las prestaciones dependen de los fluidos y de los racores utilizados. El uso está garantizado para un vacío de 755 mm Hg (99% de vacío).

Actuación

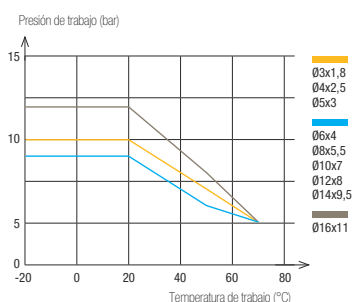

Para calcular las presiones de estallido, los valores de esta tabla se deben multiplicar por 3.

Reglamentaciones

- | | |
|---------------|--------------------------------------|
| Industriales: | Alimentarios (PU poliéter "cristal") |
| • RoHS | • FDA |
| • PED | • 1935/2004 |
| • REACH | |

Ventajas

3 grados de material

- Éster PU: aplicaciones neumáticas estándar
- Éter PU: adecuado para la hidrólisis; mayor resistencia química en comparación con el éster PU
- PU éter cristal grado alimenticio: mayor resistencia química en comparación con el PU éter
- Propiedades mecánicas: flexible, pequeño radio de flexión, absorción de vibraciones, resistente a los rayos UV

Ø exterior del tubo

Tolerancias sobre Ø exterior

3 a 8 mm	+0,10 / -0,10
10 a 16 mm	+0,15 / -0,15

Embalaje

TubePack®: 25 m, 100 m
Tambor: 300 m, 500 m, 1 000 m

Conectados a los racores instantáneos Parker Legris, los tubos PU garantizan al usuario una perfecta estanqueidad gracias a su calibrado según la norma NF E49-101.

1025U Tubo poliuretano (PU) poliéster

Tubepack® 25 m

ØD ext.	ØD int.	R							Kg
3	1,8	8	1025U03 01 18						0,131
4	2,5	10	1025U04 01	1025U04 02	1025U04 03	1025U04 04	1025U04 05	1025U04 06	0,310
5	3	13	1025U05 01			1025U05 04			0,522
6	4	15	1025U06 01	1025U06 02	1025U06 03	1025U06 04	1025U06 05	1025U06 06	0,591
8	5,5	20	1025U08 01	1025U08 02	1025U08 03	1025U08 04	1025U08 05	1025U08 06	0,971
10	7	25	1025U10 01	1025U10 02		1025U10 04	1025U10 05	1025U10 06	1,210
12	8	35	1025U12 01	1025U12 02		1025U12 04	1025U12 05	1025U12 06	2,406
14	9,5	45	1025U14 01 95			1025U14 04 95			2,815
16	11	45	1025U16 01 11	1025U16 02 11	1025U16 03 11	1025U16 04 11			2,815

Tubos en pulgadas disponibles baja demanda

1100U Tubo poliuretano (PU) poliéster

Tubepack® 100 m







ØD ext.	ØD int.	R							Kg
4	2,5	10	1100U04 01	1100U04 02	1100U04 03	1100U04 04	1100U04 05	1100U04 06	1,092
5	3	13	1100U05 01			1100U05 04			1,092
6	4	15	1100U06 01	1100U06 02	1100U06 03	1100U06 04	1100U06 05	1100U06 06	2,064
8	5,5	20	1100U08 01	1100U08 02	1100U08 03	1100U08 04	1100U08 05	1100U08 06	3,200
10	7	25	1100U10 01			1100U10 04			5,200
12	8	35	1100U12 01			1100U12 04			7,464
14	9,5	45	1100U14 01 95			1100U14 04 95			10,264
16	11	45	1100U16 01 11			1100U16 04 11			12,676

Tubos en pulgadas disponibles baja demanda

Tubo PU







2003U Tubo poliuretano (PU) poliéster

Tambor 300 m

ØD ext.	ØD int.							Kg
10	7	25	2003U10 01	2003U10 02	2003U10 03	2003U10 04	2003U10 06	16,600







2005U Tubo poliuretano (PU) poliéster

Tambor 500 m

ØD ext.	ØD int.							Kg
8	5,5	20	2005U08 01	2005U08 02	2005U08 03	2005U08 04	2005U08 05	17,100









2010U Tubo poliuretano (PU) poliéster

Tambor 1000 m

ØD ext.	ØD int.								Kg
4	2,5	12	2010U04 01	2010U04 02	2010U04 03	2010U04 04	2010U04 05	2010U04 06	9,840
6	4	15	2010U06 01	2010U06 02	2010U06 03	2010U06 04	2010U06 05	2010U06 06	20,460









1025U..R Tubo poliuretano (PU) poliéster

TubePack® 25 m

ØD ext.	ØD int.				 alta pureza	 Cristal	 Cristal	 Cristal	 Cristal	Kg
4	2,5	12	1025U04R01	1025U04R04	1025U04R08	1025U04R12	1025U04R13	1025U04R14	1025U04R17	0,310
5	3	13			1025U05R08					0,522
6	4	15	1025U06R01	1025U06R04	1025U06R08	1025U06R12	1025U06R13	1025U06R14	1025U06R17	0,591
8	5,5	20	1025U08R01	1025U08R04	1025U08R08	1025U08R12	1025U08R13	1025U08R14	1025U08R17	0,971
10	7	25	1025U10R01	1025U10R04	1025U10R08			1025U10R14		1,467
12	8	35	1025U12R01	1025U12R04	1025U12R08			1025U12R14		2,406
14	9,5	45		1025U14R04 95						2,421
16	11	45			1025U16R08 11					2,815

1100U ..R Tubo poliuretano (PU) poliéster

TubePack® 100 m

ØD ext.	ØD int.				 alta pureza	 Cristal	 Cristal	 Cristal	 Cristal	Kg
4	2,5	12	1100U04R01	1100U04R04	1100U04R08	1100U04R12	1100U04R13	1100U04R14	1100U04R17	1,092
6	4	15	1100U06R01	1100U06R04	1100U06R08	1100U06R12	1100U06R13	1100U06R14	1100U06R17	2,064
8	5,5	20	1100U08R01	1100U08R04	1100U08R08	1100U08R12	1100U08R13	1100U08R14	1100U08R17	3,610
10	7	25			1100U10R08			1100U10R14		6,109
12	8	35		1100U12R04	1100U12R08					8,610
14	9,5	45			1100U14R08 95					10,000
16	11	45			1100U16R08 11					12,176

2003U..R Tubo poliuretano (PU) poliéster

Tambor 300 m

ØD ext.	ØD int.				 alta pureza	Kg
10	7	25	2003U10R01	2003U10R04	2003U10R08	16,600

2005U..R Tubo poliuretano (PU) poliéster

Tambor 500 m

ØD ext.	ØD int.				 alta pureza	Kg
8	5,5	20	2005U08R01	2005U08R04	2005U08R08	15,600

2010U..R Tubo poliuretano (PU) poliéster

Tambor 1000 m

ØD ext.	ØD int.				 alta pureza	Kg
4	2,5	12			2010U04R08	8,868
6	4	15	2010U06R01	2010U06R04	2010U06R08	18,600

Tubo PU anti-estático



El tubo de PU antiestático garantiza la disipación de la electricidad estática acumulada.

Ø métrico:
3 a 12 mm

Características técnicas

- **Fluidos adecuados:** Aire comprimido, fluidos industriales
- **Presión de trabajo:** De vacío hasta 10 bar
- **Temperatura de trabajo:** -20°C a +70°C
- **Materiales:** Poliuretano con aditivo conductivo (50 shore D)

Las prestaciones dependen de los fluidos y de los racores utilizados.
El uso está garantizado para un vacío de 755 mm Hg (99% de vacío).

Ventajas

- Resistividad constante de $10^9 \Omega \cdot \text{cm}$ sobre el espesor de la pared
- Buena resistencia química, resistencia a los rayos UV
- Radio de curvatura mínimo: máximo ahorro de espacio
- Compatibilidad de la zona ATEX: por favor, póngase en contacto con nosotros

Reglamentaciones

- ATEX (por favor consúltenos)
- RoHS
- REACH

Actuación

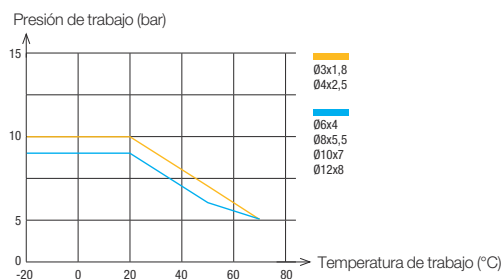

Para calcular las presiones de estallido, los valores de esta tabla se deben multiplicar por 3.

Ø exterior del tubo	Tolerancias sobre Ø exterior
3 a 8 mm	+0,10 / -0,10
10 a 12 mm	+0,15 / -0,15

Embalaje
Tubepack®: 100 m

Conectados a los racores instantáneos Parker Legris, los tubos Parker Legris garantizan al usuario una perfecta estanqueidad gracias a su calibrado según la norma NF E49-101.

1100U..A Tubo poliuretano (PU) poliéster anti-estático

Tubepack® 100 m

ØD ext.	ØD int.	R		Kg
3	1,8	10	1100U03A01	0,836
4	2,5	12	1100U04A01	1,092
6	4	15	1100U06A01	2,064
8	5,5	25	1100U08A01	3,610
10	7	35	1100U10A01	6,105
12	8	45	1100U12A01	8,610

Productos asociados

Para conservar las propiedades anti-estáticas a lo largo de todo el circuito, se recomienda asociar estos tubos a racores metálicos.

Racores instantáneos

LF 3600



LF 3800



Racores de compresión

Latón



Acero inoxidable



Tubo PU anti-chispas



El tubo de PU anti-chispas está disponible en 2 versiones, principalmente para aplicaciones de soldadura : PU poliéter de una sola capa o recubierto de PVC, resistente a las chispas, sin comprometer la flexibilidad.

Ø métrico:
6 a 12 mm

Características técnicas

- **Fluidos adecuados:** Fluidos industriales, aire comprimido, líquidos de refrigeración
- **Presión de trabajo:** De vacío hasta 14 bar
- **Temperatura de trabajo:** -20°C a +70°C
- **Materiales:** PU poliéter con funda de PVC
PU poliéter monocapa (50 shore D)

Las prestaciones dependen de los fluidos y de los racores utilizados.
El uso está garantizado para un vacío de 755 mm Hg (99% de vacío).

Ventajas

PU de una sola capa:

- Flexible para un radio de curvatura optimizado
- Flexible para una larga vida útil a altas velocidades

PU recubierto de PVC:

- Vaina de PVC auto-extinguible para proteger el tubo interior
- Resistente a la torsión, al aplastamiento

Actuación

Ø exterior del tubo	Tolerancias sobre Ø exterior	Funda de PVC espesor y tolerancias
6 a 8 mm	+0,10/-0,10	1mm
10 a 12 mm	+0,15/-0,15	+0,10/-0,10

Conectados a los racores instantáneos Parker Legris, los tubos Parker Legris garantizan al usuario una perfecta estanqueidad gracias a su calibrado según la norma NF E49-101 (tubo interior para el tubo con funda o tubo monocapa).

Reglamentaciones

- **UL94 (resistencia al fuego)**
- **RoHS**
- **REACH**

Tubo de poliuretano anti-chispas con funda de PVC

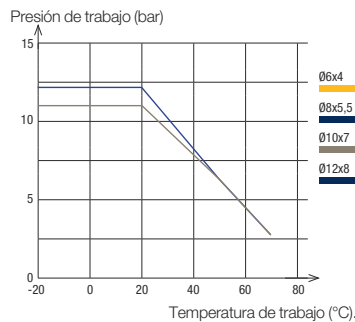

Para calcular las presiones de estallido, los valores de estas tablas se deben multiplicar por 3.

Tubo de poliuretano anti-chispas (monocapa)

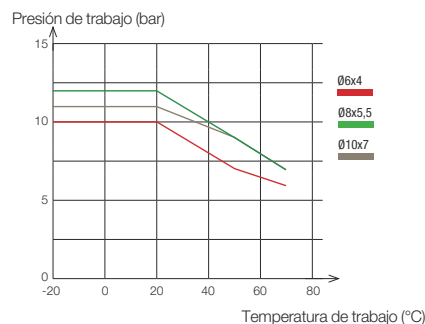

1025U..V Tubo poliuretano (PU) poliéter con revestimiento anti-chispas

Tubepack® 25 m

ØD ext.	ØD int.	R				Kg	
6	4	12	1025U06V01		1025U06V03	1025U06V04	1,200
8	5,5	20	1025U08V01		1025U08V03	1025U08V04	1,620
10	7	25	1025U10V01		1025U10V03	1025U10V04	2,900
12	8	35	1025U12V01	1025U12V02	1025U12V03		4,030

1100U..V Tubo poliuretano (PU) poliéter con revestimiento anti-chispas





Tubepack® 100 m

ØD ext.	ØD int.	R			Kg
6	4	12	1100U06V01		5,370
8	5,5	20	1100U08V01	1100U08V02	7,626
10	7	25	1100U10V01		10,864

Tubo PU anti-chispas





1025U..K Tubo poliuretano (PU) poliéter monocapa anti-chispas

Tubepack® 25 m

ØD ext.	ØD int.	R					Kg
6	4	15	1025U06K01	1025U06K02	1025U06K03	1025U06K04	0,580
8	5,5	20	1025U08K01	1025U08K02	1025U08K03	1025U08K04	0,860
10	7	25	1025U10K01	1025U10K02	1025U10K03	1025U10K04	1,230

1100U..K Tubo poliuretano (PU) poliéter monocapa anti-chispas

Tubepack® 100 m

ØD ext.	ØD int.	R					Kg
6	4	15	1100U06K01	1100U06K02	1100U06K03	1100U06K04	2,320
8	5,5	20	1100U08K01	1100U08K02	1100U08K03	1100U08K04	3,030
10	7	25	1100U10K01	1100U10K02	1100U10K03	1100U10K04	5,100

6000 71 00 Útil de desenfundado

Polímero técnico, acero inoxidable



Kg

6000 71 00

0,098

Principio de funcionamiento

Herramienta de desenfundado 6000 71 00



1. Colocar el tubo en la herramienta de desenfundado para ajustar la altura de la cuchilla al espesor del tubo.

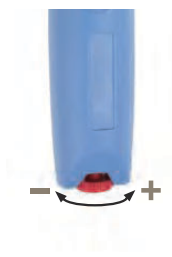

2. El ajuste de la altura de la cuchilla se realiza mediante la rueda que se encuentra debajo del mango.

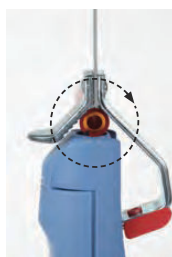

3. Una vez efectuado el ajuste, realizar una rotación de la herramienta de 360° alrededor del tubo.



4. Efectuar una presión en la parte metálica de la herramienta para sujetar bien el tubo.



5. Desplazar la herramienta hacia el extremo del tubo para realizar una abertura axial de la funda.



6. El tubo se ha desenfundado de manera limpia.

Tubo PE



El tubo de polietileno existe en 2 grados: PE de baja densidad o "PE avanzado" 50% reticulado. Destinados a aplicaciones de procesamiento de alimentos o de transmisión de fluidos, los tubos de PE son seguros para la salud de los usuarios.

Ø métrico:
4 a 16 mm

Características técnicas

Tubo	PE Avanzado	PE baja densidad
Fluidos adecuados	Agua, bebidas y otros fluidos	Fluidos industriales
Presión de trabajo	De vacío hasta 16 bar	De vacío hasta 20 bar
Temperatura de trabajo	-40°C a +95°C	-40°C a +60°C
Materiales	Polietileno: 50% PE reticulado 50% PE baja densidad (53 shore D)	Polietileno baja densidad (44 shore D)

Las prestaciones dependen de los fluidos y de los racores utilizados. El uso está garantizado para un vacío de 755 mm Hg (99% de vacío).

Reglamentaciones

Tubo PE Avanzado:	<ul style="list-style-type: none"> • ACS • WRAS • KTW • W270 • PED • RoHS • DM174 	Tubo PE baja densidad:
<ul style="list-style-type: none"> • FDA: 21CFR 177.1520 • 1935/2004 • NSF 42/58 • NSF 51 • NSF 61 C-HOT 	<ul style="list-style-type: none"> • FDA: 21CFR 177.1520 • RoHS • PED 	

Ventajas

Tubo PE Avanzado

- Aprobado para el contacto con bebidas y productos alimenticios
- Resistente a una amplia gama de productos químicos y de limpieza, estable, bajo los rayos UV
- Excelente compromiso entre el radio de curvatura y la resistencia a la presión / temperatura

Tubo PE baja densidad

- Material de grado alimenticio
- Resistencia a los agentes corrosivos y agresivos

Actuación

Tubo PE Advanced

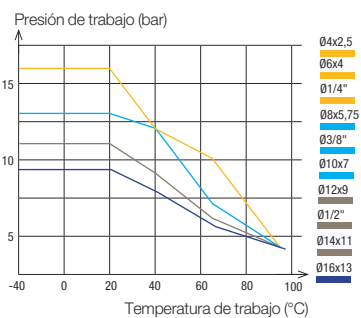

Tubo PE baja densidad

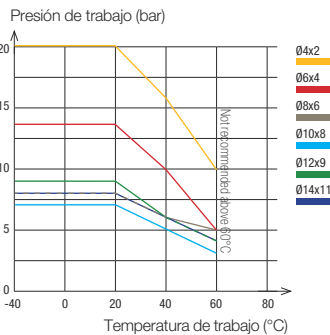

Para calcular las presiones de estallido, los valores de esta tabla se deben multiplicar por 3.

Ø exterior del tubo	Tolerancias sobre Ø exterior
1/4" a 1/2"	+0,10 / -0,10
4 a 16 mm	+0,10 / -0,10

Conectados a los racores instantáneos Parker Legris, los tubos Parker Legris garantizan al usuario una perfecta estanqueidad gracias a su calibrado.

Embalaje

Tubo PE Advanced
Tambor: 75 m, 150 m, 300 m, 250 pies, 500 pies
Tubo PE baja densidad
Tubepack®: 100 m

1015Y..F Tubo polietileno Advanced (APE)

Tambor 150 m

ØD ext.	ØD int.	R	incoloro	negro	verde	rojo	azul	blanco	Kg
6	4	32	1015Y06F00	1015Y06F01			1015Y06F04		5,434
8	5,8	40	1015Y08F00	1015Y08F01	1015Y08F02	1015Y08F03	1015Y08F04	1015Y08F10	3,279
10	7	40	1015Y10F00	1015Y10F01	1015Y10F02	1015Y10F03	1015Y10F04	1015Y10F10	5,318

1030Y..F Tubo polietileno Advanced (APE)







Tambor 300 m

ØD ext.	ØD int.	R	incoloro	negro	verde	rojo	azul	blanco	Kg
4	2,5	16	1030Y04F00	1030Y04F01					2,860
6	4	32	1030Y06F00	1030Y06F01	1030Y06F02	1030Y06F03	1030Y06F04	1030Y06F10	4,424

Tubo PE

1075Y..F Tubo polietileno Advanced (APE)

Tambor 75 m

ØD ext.	ØD int.		 incoloro					 blanco	Kg
12	9	55	1075Y12F00	1075Y12F01	1075Y12F02	1075Y12F03	1075Y12F04	1075Y12F10	3,852
14	11	75	1075Y14F00	1075Y14F02					5,850
16	13	90	1075Y16F00						7,750

1096Y..F Tubo polietileno Advanced (APE)

Tambor 250 ft

ØD ext.	ØD int.		 incoloro			Kg
12	0,4	2	1096Y62F00	1096Y62F01	1096Y62F04	4,200



1098Y..F Tubo polietileno Advanced (APE)

Tambor 500 ft

ØD ext.	ØD int.		 incoloro				Kg
14	0,2	0,8	1098Y56F00	1098Y56F01	1098Y56F03	1098Y56F04	2,334
38	0,3	1,2	1098Y60F00	1098Y60F01			5,518

1100Y Tubos de polietileno avanzado de baja densidad

Tubepack® 100 m

ØD ext.	ØD int.		 incoloro	Kg
4	2	25	1100Y04 00	0,910
6	4	35	1100Y06 00	1,500
8	6	55	1100Y08 00	2,140
10	8	80	1100Y10 00	2,710
12	9	65	1100Y12 00	4,750
14	11	80	1100Y14 00	5,650

Tubo fluoropolímero – FEP



El tubo de fluoropolímero FEP (etileno propileno fluorado) ofrece una buena resistencia mecánica. Transparente, permite el control de fluidos sin compromiso técnico.

Ø métrico:
4 a 12 mm

Características técnicas

- **Fluidos adecuados:** Fluidos industriales
- **Presión de trabajo:** 0 a 28 bar
- **Temperatura de trabajo:** -40°C a +150°C
- **Materiales:** Etileno propileno fluorado (puro) (55 Shore D)

Las prestaciones dependen de los fluidos y de los racores utilizados.

Actuación

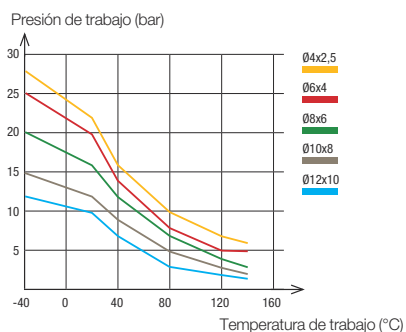

Reglamentaciones

- | | |
|-------------------|---------------|
| Agroalimentarias: | Industriales: |
| • FDA | • RoHS |
| | • PED |
| | • REACH |

Ventajas

- Material flexible e ignífugo
- La FDA aprobó la resistencia a los agentes químicos y a los disolventes

Ø exterior del tubo	Tolerancias sobre Ø exterior
---------------------	------------------------------

4 mm	+0,05 / -0,05
6 a 10 mm	+0,07 / -0,07
12 mm	+0,10 / -0,10

Embalaje
Tubepack®: 5 m, 25 m

Conectados a los racores instantáneos Parker Legris, los tubos Parker Legris garantizan al usuario una perfecta estanqueidad gracias a su calibrado.

1005T Tubo fluoropolímero (FEP)

Tubepack® 5 m

ØD ext.	ØD int.	R	incoloro		Kg
4	2,5	40	1005T04 00 25		0,155
6	4	50	1005T06 00		0,250
8	6	70	1005T08 00		0,385
10	8	120	1005T10 00		0,524
12	10	180	1005T12 00		0,547

1025T Tubo fluoropolímero (FEP)

Tubepack® 25 m

ØD ext.	ØD int.	R	incoloro		Kg
4	2,5	40	1025T04 00 25		0,506
6	4	50	1025T06 00		1,025
8	6	70	1025T08 00		1,431
10	8	120	1025T10 00		1,693
12	10	180	1025T12 00		1,913

Productos asociados

Los racores de acero inoxidable son perfectamente adecuados para los tubos de fluoropolímeros (PFA, FEP).

Racores Instantáneos

LF 3800



Racores de compresión

Acero inoxidable



Tubo de fluoropolímero - PFA



La gama de tubos de PFA (perfluoroalcoxi) está disponible en 3 grados de material que ofrecen una vida útil 10 veces más larga que la de otros tubos de fluoropolímero bajo severas restricciones químicas y mecánicas. Es compatible con todas las aplicaciones y entornos extremos.

Ø métrico:
4 a 12 mm

Características técnicas

- **Fluidos adecuados:** Médicos, biocompatibles, alimentarios, gas, aire comprimido
- **Presión de trabajo:** De vacío hasta 36 bar
- **Temperatura de trabajo:** Mini -40°C
Maxi +150°C con casquillos para condiciones severas de uso
- **Materiales:** Perfluoroalcoxi (55 Shore D)
 - PFA Alta Pureza
 - PFA coloreado translúcido
 - PFA anti-estático

Las prestaciones dependen de los fluidos y de los racores utilizados. El uso está garantizado para un vacío de 755 mm Hg (99% de vacío).

Actuación

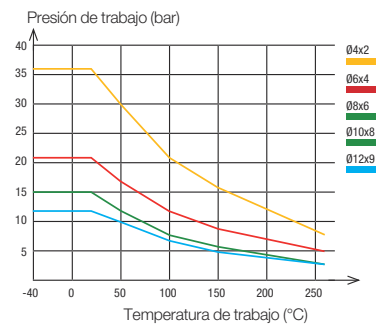

Para calcular las presiones de estallido, los valores de esta tabla se deben multiplicar por 3.

Ventajas

- Resistencia mecánica excepcional: una alternativa a los tubos de acero inoxidable
- Excepcional resistencia química: antiadhesivo, inercia química, baja permeabilidad, no inflamable, transparente a los rayos UV.

3 grados de materiales

- PFA transparente de alta pureza: resistencia mecánica bajo tensión
- PFA de color translúcido: identificación de los circuitos
- PFA antiestático negro: sin descarga electrostática

Reglamentaciones

- | | |
|-------------------|----------------------|
| Médicas: | Industriales: |
| • USP: Class VI | • ULV94 |
| Agroalimentarios: | • RoHS |
| • FDA | • PED |
| • 1935/2004 | • REACH |

Ø exterior del tubo Tolerancias sobre Ø exterior

4 a 8 mm	+0,10 / -0,10
10 a 12 mm	+0,15 / -0,15

Embalaje
Tubepack®: 10 m, 50 m, 100 m

Conectados a los racores instantáneos Parker Legris, los tubos garantizan una perfecta estanqueidad gracias a su calibrado, según la norma NF E49-100.

1050T..P Tubo fluoropolimero (FEP)

Tubepack® 50 m

ØD ext.	ØD int.	R	incoloro	Cristal	Cristal	Cristal	Kg
4	2	12	1050T04P00	1050T04P12	1050T04P13	1050T04P14	0,435
6	4	34	1050T06P00	1050T06P12	1050T06P13	1050T06P14	1,185
8	6	60	1050T08P00	1050T08P12	1050T08P13	1050T08P14	2,050
10	8	95	1050T10P00				3,186
12	9	120	1050T12P00				5,692

Ø 10 mm y 12 mm: los colores verde, rojo y azul están disponibles a petición, con una cantidad mínima de pedido.

1100T..P Tubo fluoropolimero (FEP)

Tubepack® 100 m

ØD ext.	ØD int.	R	incoloro	Kg
6	4	34	1100T06P00	3,485
8	6	60	1100T08P00	4,805
10	8	95	1100T10P00	7,230
12	9	120	1100T12P00	11,183

1010T..A Tubo fluoropolimero (PFA) anti-estático

Tubepack® 10 m

ØD ext.	ØD int.	R	anti-estático	Kg
4	2	12	1010T04A01	0,243
6	4	34	1010T06A01	0,392
8	6	60	1010T08A01	0,549
10	8	95	1010T10A01	0,732

Multi-tubos



Los multitubos PA o PU optimizan el espacio de cableado de los circuitos neumáticos.

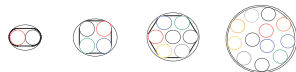

Ø métrico:
4 a 8 mm

Características técnicas

Tubo	PA	PU
Fluidos adecuados	Aire comprimido, fluidos químicos e industriales	Aire comprimido, fluidos industriales
Presión de trabajo	De vacío hasta 24 bar	0 a 14 bar
Temperatura de trabajo	-40°C a +80°C	-20°C a +70°C
Materiales	Poliamida	Poliuretano poliéster

Las prestaciones dependen de los fluidos y de los racores utilizados.
El uso está garantizado para un vacío de 755 mm Hg (99% de vacío).

Ventajas

Tubo PA en haz

- De 2 a 12 tubos numerados para la identificación de los circuitos
- Revestimiento de PVC resistente a la abrasión, las chispas, el ataque químico
- Haz helicoidal para un radio de curvatura mínimo

Tubo PU poliéster en bi-tubo

- 3 combinaciones de colores disponibles para la identificación del circuito
- El tubo está completamente unido
- El diámetro exterior y la forma circular se mantienen después de la separación

Reglamentaciones

- RoHS
- PED
- REACH

Actuación

Tubo PA semi-rígido en haz

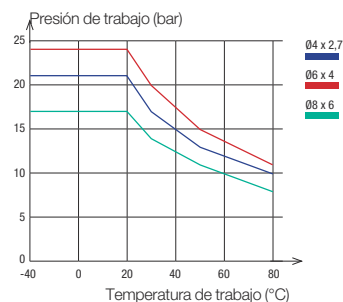

PU poliéster bi-tubo

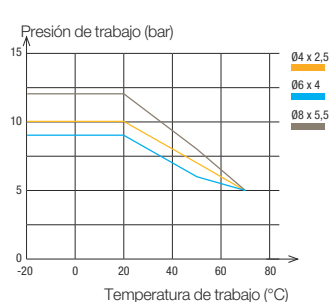

Para calcular las presiones de estallido, los valores de esta tabla se deben multiplicar por 3.

Material	Ø exterior del tubo	Tolerancias sobre Ø exterior
PA	4 mm	+0,05 / -0,08
	6 a 8 mm	+0,05 / -0,10
PU	4 a 8 mm	+0,10 / -0,10

Conectados a los racores instantáneos Parker Legris, los tubos Parker Legris garantizan al usuario una perfecta estanqueidad gracias a su calibrado según la norma NF E49-100 (para la PA semi-rígida) y NF E49-101 (para el bitubo PU).

1010P..M Multi-tubo poliamida (PA) semi-rígido en haz

Rollos 10 m

ØD ext.	ØD int.	R	Núm. de salidas		Kg
4	2,7	45	7	1010P04 00M04	1,440
	2,7	45	7	1010P04 00M07	1,440
6	4	60	4	1010P06 00M04	2,300
	4	60	7	1010P06 00M07	1,440
8	6	45	2	1010P08 00M02	2,600

1050P..M Multi-tubo poliamida (PA) semi-rígido en haz

Rollos 50 m

ØD ext.	ØD int.	R	Núm. de salidas		Kg
4	2,7	55	2	1050P04 00M02	5,450
	2,7	55	4	1050P04 00M04	5,450
	2,7	55	7	1050P04 00M07	5,450
	2,7	55	12	1050P04 00M12	5,450
6	4	60	2	1050P06 00M02	9,100
	4	60	4	1050P06 00M04	5,450
8	4	60	7	1050P06 00M07	5,450
	6	45	2	1050P08 00M02	13,600

1420U Bitubo poliuretano (PU) poliéster plano

Tube-pack® 25 m

ØD ext.	ØD int.	R			Kg
4	2,5	12	1420U04 11	1420U04 41	0,620
6	4	15	1420U06 11	1420U06 41	1,182
8	5,5	20	1420U08 11	1420U08 41	1,942

Tubo PA en espiral

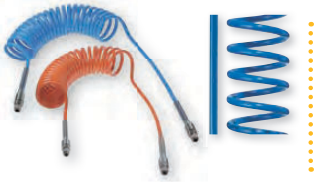

El tubo en espiral de PA es una alternativa a los carretes gracias a la remanencia de la forma de retroceso dada al tubo de PA.

Legris Ø métrico: 6 a 8 mm
Rectulastic Ø métrico: 4,7 a 15,8 mm

Legris Tubo PA en espiral

Características técnicas

- **Fluidos adecuados:** Aire comprimido, lubricantes, otros fluidos: por favor, consúltenos
- **Presión de trabajo:** De vacío hasta 20 bar
- **Temperatura de trabajo:** -20°C a +80°C
- **Materiales:** Poliamida (60 Shore D)

Las prestaciones dependen de los fluidos y de los racores utilizados.
El uso está garantizado para un vacío de 755 mm Hg (99% de vacío).

Ventajas

- Auto-retráctil debido a la memoria duradera de la forma
- Resorte protector para mantener la integridad del tubo
- 2 colores para la identificación del circuito

Reglamentaciones

Industriales: • PED • REACH • RoHS

Rendimiento de los tubos de retroceso de PA de Parker Legris

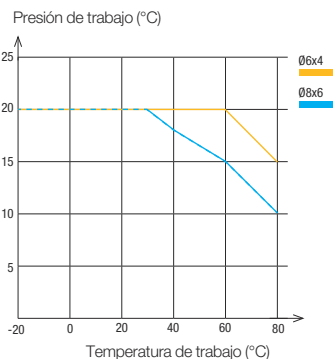

Para calcular las presiones de estallido, los valores de esta tabla se deben multiplicar por 3.

Ø exterior del tubo	Ø de paso	Tolerancias sobre Ø exterior
6 mm	4 mm	+0,05/-0,10
8 mm	6 mm	+0,05/-0,10

Rectulastic Tubo PA en espiral

Características técnicas

- **Materiales:** Polyamide 12
- **Fluidos adecuados:** Aire comprimido, Lubricación, grasa/aceite, Gasolina, Hidráulica, Vacío, Químicos (bajo petición)
- **Presión de trabajo:** 15 bar
- **Temperatura de trabajo:** -40°C hasta +90°C
- **Temperatura de trabajo para el montaje de los tubos:** -20°C a +70°C

Ventajas

- Ligero
- Amplio rango de temperatura
- Largo tiempo de servicio
- Una gran elasticidad

Desempeño de los tubos Rectulastic

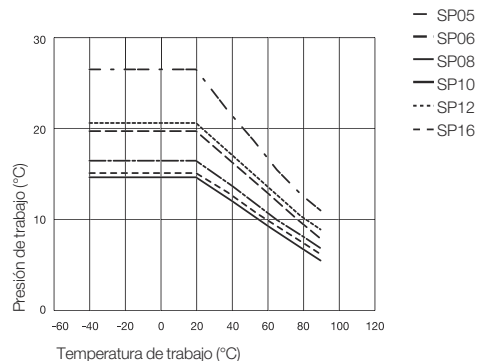

1470P Tubo poliamida (PA) en espiral 2 m, rosca macho BSPT

ØD ext.	ØD int.	C			Longitud de las espiras recogidas	Ø de la espira	Kg
6	4	R1/4	1470P06 04 13	1470P06 07 13	520	60	0,143
8	6	R1/4	1470P08 04 13	1470P08 07 13	560	70	0,174

Longitud de la extremidad corta del tubo: 100 mm
Longitud de la extremidad larga del tubo: 300 mm



1471P Tubo poliamida (PA) en espiral 4 m, rosca macho BSPT

ØD ext.	ØD int.	C			Longitud de las espiras recogidas	Ø de la espira	Kg
6	4	R1/4	1471P06 04 13	1471P06 07 13	640	60	0,199
8	6	R1/4	1471P08 04 13	1471P08 07 13	720	70	0,249

Longitud de la extremidad corta del tubo: 100 mm
Longitud de la extremidad larga del tubo: 300 mm

Tubo PA en espiral

1472P Tubo poliamida (PA) en espiral 6 m, rosca macho BSPT

ØD ext.	ØD int.	C			Longitud de la espiras recogidas	Ø de la espira	Kg
6	4	R1/4	1472P06 04 13	1472P06 07 13	760	60	0,260
8	6	R1/4	1472P08 04 13	1472P08 07 13	880	70	0,329

Longitud de la extremidad corta del tubo: 100 mm
Longitud de la extremidad larga del tubo: 300 mm

SP../025 RECTULASTIC - Mangueras enrolladas de poliamida (PA) sin accesorios 2,5 m

ØD ext.	ØD int.		Ø de la espira
4,7	3,1	SP05/025	38
6,3	4,8	SP06/025	75
7,9	6,3	SP08/025	75
9,5	7,9	SP10/025	115
11,8	9,5	SP12/025	140

SP../050 RECTULASTIC - Mangueras enrolladas de poliamida (PA) sin accesorios 5 m

ØD ext.	ØD int.		Ø de la espira
4,7	3,1	SP05/050	38
6,3	4,8	SP06/050	75
7,9	6,3	SP08/050	75
9,5	7,9	SP10/050	115
11,8	9,5	SP12/050	140
15,8	12,7	SP16/050	220

SP../075 RECTULASTIC - Mangueras enrolladas de poliamida (PA) sin accesorios 7,5 m

ØD ext.	ØD int.		Ø de la espira
4,7	3,1	SP05/075	38
6,3	4,8	SP06/075	75
7,9	6,3	SP08/075	75
9,5	7,9	SP10/075	115
11,8	9,5	SP12/075	140
15,8	12,7	SP16/075	220

SP../100 RECTULASTIC - Mangueras enrolladas de poliamida (PA) sin accesorios 10 m

ØD ext.	ØD int.		Ø de la espira
4,7	3,1	SP05/100	38
6,3	4,8	SP06/100	75
7,9	6,3	SP08/100	75
9,5	7,9	SP10/100	115
11,8	9,5	SP12/100	140
15,8	12,7	SP16/100	220

SP../150 RECTULASTIC - Mangueras enrolladas de poliamida (PA) sin accesorios 15 m

ØD ext.	ØD int.		Ø de la espira
6,3	4,8	SP06/150	75
7,9	6,3	SP08/150	75
9,5	7,9	SP10/150	115
11,8	9,5	SP12/150	140
15,8	12,7	SP16/150	220

SP../225 RECTULASTIC - Mangueras enrolladas de poliamida (PA) sin accesorios 22,5 m

ØD ext.	ØD int.		Ø de la espira
6,3	4,8	SP06/225	75
7,9	6,3	SP08/225	75
9,5	7,9	SP10/225	115
11,8	9,5	SP12/225	140
15,8	12,7	SP16/225	220

Tubo PA en espiral

SP../025/DV RECTULASTIC - Completamente ensamblado con accesorios giratorios 2,5 m

ØD ext.	ØD int.	C		Ø de la espira
4,7	3,1	R1/8	SP05/025/DV	38
7,9	6,3	R1/4	SP08/025/DV	75
9,5	7,9	R1/4	SP10/025/DV	115
11,8	9,5	R3/8	SP12/025/DV	140

Manguera de poliamida con accesorios giratorios y protectores de resorte (Tipo DV)

SP../050/DV RECTULASTIC - Completamente ensamblado con accesorios giratorios de 5 m

ØD ext.	ØD int.	C		Ø de la espira
4,7	3,1	R1/8	SP05/050/DV	38
7,9	6,3	R1/4	SP08/050/DV	75
9,5	7,9	R1/4	SP10/050/DV	115
11,8	9,5	R3/8	SP12/050/DV	140
15,8	12,7	R1/2	SP16/050/DV	220

Manguera de poliamida con accesorios giratorios y protectores de resorte (Tipo DV)

SP../075/DV RECTULASTIC - Completamente ensamblado con accesorios giratorios 7,5 m

ØD ext.	ØD int.	C		Ø de la espira
4,7	3,1	R1/8	SP05/075/DV	38
7,9	6,3	R1/4	SP08/075/DV	75
9,5	7,9	R1/4	SP10/075/DV	115
11,8	9,5	R3/8	SP12/075/DV	140
15,8	12,7	R1/2	SP16/075/DV	220

Manguera de poliamida con accesorios giratorios y protectores de resorte (Tipo DV)

SP../100/DV RECTULASTIC - Completamente ensamblado con accesorios giratorios de 10 m

ØD ext.	ØD int.	C		Ø de la espira
4,7	3,1	R1/8	SP05/100/DV	38
7,9	6,3	R1/4	SP08/100/DV	75
9,5	7,9	R1/4	SP10/100/DV	115
11,8	9,5	R3/8	SP12/100/DV	140
15,8	12,7	R1/2	SP16/100/DV	220

Manguera de poliamida con accesorios giratorios y protectores de resorte (Tipo DV)

SP../150/DV RECTULASTIC - Completamente ensamblado con accesorios giratorios de 15 m

ØD ext.	ØD int.	C		Ø de la espira
7,9	6,3	R1/4	SP08/150/DV	75
9,5	7,9	R1/4	SP10/150/DV	115
11,8	9,5	R3/8	SP12/150/DV	140
15,8	12,7	R1/2	SP16/150/DV	220

Manguera de poliamida con accesorios giratorios y protectores de resorte (Tipo DV)

SP../225/DV RECTULASTIC - Completamente ensamblado con accesorios giratorios 22,5 m

ØD ext.	ØD int.	C		Ø de la espira
7,9	6,3	R1/4	SP08/225/DV	75
9,5	7,9	R1/4	SP10/225/DV	115
11,8	9,5	R3/8	SP12/225/DV	140
15,8	12,7	R1/2	SP16/225/DV	220

Manguera de poliamida con accesorios giratorios y protectores de resorte (Tipo DV)

Tubo PA en espiral

SP../025/K+S RECTULASTIC - Completamente ensamblado con el acoplamiento y el enchufe 2,5 m

ØD ext.	ØD int.		Ø de la espira
7,9	6,3	SP08/025/K+S	75
9,5	7,9	SP10/025/K+S	115
11,8	9,5	SP12/025/K+S	140

Manguera de poliamida con acoplamiento de la serie 26 y enchufe con protectores de resorte

SP../050/K+S RECTULASTIC - Completamente ensamblado con el acoplamiento y el enchufe 5 m

ØD ext.	ØD int.		Ø de la espira
7,9	6,3	SP08/050/K+S	75
9,5	7,9	SP10/050/K+S	115
11,8	9,5	SP12/050/K+S	140

Manguera de poliamida con acoplamiento de la serie 26 y enchufe con protectores de resorte

SP../075/K+S RECTULASTIC - Completamente ensamblado con el acoplamiento y el enchufe 7,5 m

ØD ext.	ØD int.		Ø de la espira
7,9	6,3	SP08/075/K+S	75
9,5	7,9	SP10/075/K+S	115
11,8	9,5	SP12/075/K+S	140

Manguera de poliamida con acoplamiento de la serie 26 y enchufe con protectores de resorte

SP../100/K+S RECTULASTIC - Completamente ensamblado con el acoplamiento y el enchufe 10 m

ØD ext.	ØD int.		Ø de la espira
7,9	6,3	SP08/100/K+S	75
9,5	7,9	SP10/100/K+S	115
11,8	9,5	SP12/100/K+S	140

Manguera de poliamida con acoplamiento de la serie 26 y enchufe con protectores de resorte

SP../150/K+S RECTULASTIC - Completamente ensamblado con el acoplamiento y el enchufe 15 m

ØD ext.	ØD int.		Ø de la espira
7,9	6,3	SP08/150/K+S	75
9,5	7,9	SP10/150/K+S	115
11,8	9,5	SP12/150/K+S	140

Manguera de poliamida con acoplamiento de la serie 26 y enchufe con protectores de resorte

SP../225/K+S RECTULASTIC - Completamente ensamblado con el acoplamiento y el enchufe 22,5 m

ØD ext.	ØD int.		Ø de la espira
7,9	6,3	SP08/225/K+S	75
9,5	7,9	SP10/225/K+S	115
11,8	9,5	SP12/225/K+S	140

Manguera de poliamida con acoplamiento de la serie 26 y enchufe con protectores de resorte

Tubo PU en espiral

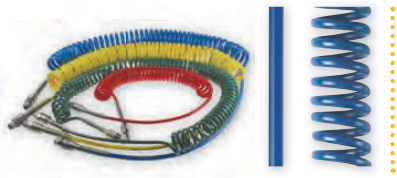

El tubo PU en espiral ofrece una alternativa a los carretes gracias a la remanencia de la forma de bobina que se le da al tubo de PU. Su flexibilidad permite un fácil manejo.

Legris Ø métrico: 4 a 12 mm
Rectuflex Ø métrico: 8 a 15 mm

Legris PU Recoil Tubing

Características técnicas

- **Fluidos adecuados:** Aire comprimido
- **Presión de trabajo:** 0 a 10 bar
- **Temperatura de trabajo:** -20°C a +70°C (tubo montado)
- **Materiales:** Poliuretano poliéster: dureza = 52 Shore D
Poliuretano poliéter: dureza = 46 Shore D

Las prestaciones dependen de los fluidos y de los racores utilizados.

Ventajas

- 2 grados de materiales: PU Poliéster y PU Poliéter
- Con o sin el montaje de los accesorios
- Auto-retráctil debido a la memoria de la forma de las bobinas
- Resorte protector para mantener la integridad del tubo
- 3 colores para la identificación del circuito

Reglamentaciones

Industriales:

- RoHS
- REACH
- PED

Rectus PU Recoil Tubing: Rectuflex

Características técnicas

- **Fluidos adecuados:** Aire comprimido, Grasa/aceite de lubricación, Gasolina, Hidráulica, Vacío, Química (a petición), Alimentación y Beverage (a petición)
- **Presión de trabajo:** 10 bar
- **Temperatura de trabajo:** -40°C hasta +75°C
-20°C hasta +70°C (tubo montado)
- **Materiales:** Poliuretano Nycoil

Ventajas

- Manguera ligera y extremadamente duradera
- Baja caída de presión
- Alta resistencia a la abrasión
- Un radio de curvatura muy pequeño y un diámetro de bobina muy ajustado
- Elasticidad superior y memoria de la bobina

Rendimiento de los tubos de recuperación de PU Legris

Tubo PU poliéster en espiral

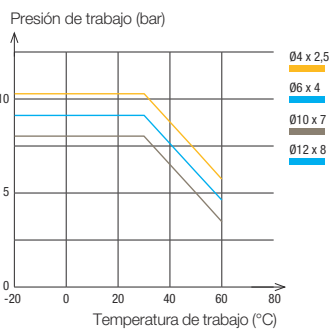

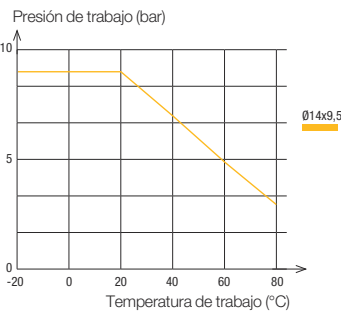

Tubo PU poliéter en espiral



Las prestaciones dependen de los fluidos, del material y del tubo utilizados.

Ø exterior del tubo	Ø de paso	Tolerancias sobre Ø exterior
8 mm	2,5 a 5,5 mm	+0,10 / -0,10
10 a 12 mm	7 a 8 mm	+0,15 / -0,15



1470U Tubo poliuretano (PU) poliéster en espiral 2 m, rosca macho BSPT

ØD ext.	ØD int.	C				Longitud de la espiras recogidas	Ø de la espira	Kg
4	2,5	R1/8	1470U04 03 10	1470U04 04 10	1470U04 05 10	595	24	0,060
6	4	R1/4	1470U06 03 13	1470U06 04 13	1470U06 05 13	630	32	0,060
8	5	R1/4	1470U08 03 13	1470U08 04 13	1470U08 05 13	780	45	0,120
10	7	R1/4	1470U10 03 13	1470U10 04 13	1470U10 05 13	780	65	0,160
12	8	R3/8	1470U12 03 17	1470U12 04 17	1470U12 05 17	780	75	0,190

Longitud de la extremidad larga Ø ext. < 8 mm: 300 mm, Longitud de la extremidad larga Ø ext. ≥ 8 mm: 500 mm, Longitud de la extremidad corta, lo que sea el Ø ext.: 100 mm



Tubo PU en espiral

1471U Tubo poliuretano (PU) poliéster en espiral 4 m, rosca macho BSPT

ØD ext.	ØD int.	C				Longitud de la espiras recogidas	Ø de la espira	Kg
4	2,5	R1/8	1471U04 03 10	1471U04 04 10	1471U04 05 10	785	24	0,100
6	4	R1/4	1471U06 03 13	1471U06 04 13	1471U06 05 13	850	32	0,160
8	5	R1/4	1471U08 03 13	1471U08 04 13	1471U08 05 13	1 000	45	0,200
10	7	R1/4	1471U10 03 13	1471U10 04 13	1471U10 05 13	1 000	65	0,230
12	8	R3/8	1471U12 03 17	1471U12 04 17	1471U12 05 17	1 140	75	0,260

Longitud de la extremidad larga Ø ext. < 8 mm: 300 mm , Longitud de la extremidad larga Ø ext. ≥ 8 mm: 500 mm , Longitud de la extremidad corta, lo que sea el Ø ext.: 100 mm

1472U Tubo poliuretano (PU) poliéster en espiral 6 m, rosca macho BSPT

ØD ext.	ØD int.	C				Longitud de la espiras recogidas	Ø de la espira	Kg
8	5	R1/4	1472U08 03 13	1472U08 04 13	1472U08 05 13	1 230	45	0,280
10	7	R1/4	1472U10 03 13	1472U10 04 13	1472U10 05 13	1 140	65	0,295
12	8	R3/8	1472U12 03 17	1472U12 04 17	1472U12 05 17	1 190	75	0,310

Longitud de la extremidad larga Ø ext. < 8 mm: 300 mm , Longitud de la extremidad larga Ø ext. ≥ 8 mm: 500 mm , Longitud de la extremidad corta, lo que sea el Ø ext.: 100 mm

1460U Tubo poliuretano (PU) poliéster en espiral 2 m

ØD ext.	ØD int.		Longitud de la espiras recogidas	Ø de la espira	Kg
8	5	1460U08 04	720	45	0,135
10	7	1460U10 04	720	65	0,227
12	8	1460U12 04	720	75	0,282

Longitud de la extremidad larga Ø ext. < 8 mm: 300 mm , Longitud de la extremidad larga Ø ext. ≥ 8 mm: 500 mm , Longitud de la extremidad corta, lo que sea el Ø ext.: 100 mm

1461U Tubo poliuretano (PU) poliéster en espiral 4 m

ØD ext.	ØD int.		Longitud de la espiras recogidas	Ø de la espira	Kg
8	5	1461U08 04	940	45	0,231
10	7	1461U10 04	940	65	0,411
12	8	1461U12 04	940	75	0,486

Longitud de la extremidad larga Ø ext. < 8 mm: 300 mm , Longitud de la extremidad larga Ø ext. ≥ 8 mm: 500 mm , Longitud de la extremidad corta, lo que sea el Ø ext.: 100 mm

1462U Tubo poliuretano (PU) poliéster en espiral 6 m

ØD ext.	ØD int.		Longitud de la espiras recogidas	Ø de la espira	Kg
8	5	1462U08 04	1 260	45	0,337
10	7	1462U10 04	1 260	65	0,513
12	8	1462U12 04	1 260	75	0,684

Longitud de la extremidad larga Ø ext. < 8 mm: 300 mm , Longitud de la extremidad larga Ø ext. ≥ 8 mm: 500 mm , Longitud de la extremidad corta, lo que sea el Ø ext.: 100 mm

1445U..R Tubo poliuretano (PU) poliéster en espiral 3 m, rosca macho BSPP

ØD ext.	ØD int.	C		Longitud de la espiras recogidas	Ø de la espira	Kg
14	9,5	G3/8	1445U14R04 17	759	110	0,460

Tubo PU en espiral

PU../030 RECTUFLEX - Poliuretano(PU) ensamblado con extensiones rectas de 3 m, macho BSPP Fitting

ØD ext.	ØD int.		Ø de la espira
8	5	PU08/030/DV	40
9,5	6,3	PU10/030/DV	60
12	8	PU12/030/DV	80
15	9,5	PU15/030/DV	110

Completamente ensamblado con extensiones rectas de 508 mm y 127 mm

PU../060 RECTUFLEX - Poliuretano (PU) ensamblado con extensiones rectas de 6 m, macho BSPP Fitting

ØD ext.	ØD int.	C		Ø de la espira
8	5	G1/4	PU08/060/DV	40
9,5	6,3	G1/4	PU10/060/DV	60
12	8	G3/8	PU12/060/DV	80
15	9,5	G3/8	PU15/060/DV	110

Completamente ensamblado con extensiones rectas de 508 mm y 127 mm

PU../075 RECTUFLEX - Poliuretano (PU) ensamblado con extensiones rectas de 7,5 m, macho BSPP Fitting

ØD ext.	ØD int.	C		Ø de la espira
8	5	G1/4	PU08/075/DV	40
9,5	6,3	G1/4	PU10/075/DV	60
12	8	G3/8	PU12/075/DV	80
15	9,5	G3/8	PU15/075/DV	110

Completamente ensamblado con extensiones rectas de 508 mm y 127 mm

0694 Racor con muelle de protección, rosca macho BSPP

Latón niquelado, NBR

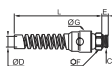

ØD	C		E	F	G	L	Kg
8	G1/4	0694 08 13	6,5	16	24	104,5	0,067
10	G1/4	0694 10 13	6,5	18	24	106,5	0,062
12	G3/8	0694 12 17	7,5	20	29,5	126	0,080

0695 Racor con muelle de protección, rosca macho BSPT

Latón niquelado, NBR

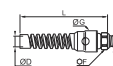

ØD	C		F	G	L	Kg
8	R1/4	0695 08 13	14	24	104,5	0,055
10	R1/4	0695 10 13	18	24	106,5	0,063
12	R3/8	0695 12 17	20	29,5	126	0,090

Tubos de PVC trenzados



Hecha de PVC industrial o de grado alimenticio, esta manguera trenzada cubre una amplia gama de aplicaciones industriales para el transporte de fluidos.

Legris Ø métrico: 4 a 19 mm
Rectusoft Ø métrico: 11 a 19 mm

Tubos trenzada de PVC Legris

Características técnicas

Tubo	PVC alimentario	PVC industrial
Fluidos adecuados	Aire comprimido, otros fluidos	Aire comprimido
Presión de trabajo	0 a 15 bar	0 a 15 bar
Temperatura de trabajo	-20°C a +70°C	-25°C a +60°C
Materiales	PVC alimentario translúcido sin ftalatos con trenza de poliéster	PVC industrial azul multicapa con trenza de poliéster

Las prestaciones dependen de los fluidos y de los racores utilizados.

Ventajas

PVC alimentario

- Tubo monogrado sin ftalatos ni silicona
- Traslúcido para visualizar el fluido, la turbulencia, la limpieza del circuito

PVC industrial

- Refuerzo trenzado entre dos grados de PVC
- Resistencia mecánica a la abrasión, al impacto, al aplastamiento

Reglamentaciones

PVC alimentario:

- FDA
- REACH
- 1935/2004
- RoHS

PVC industrial:

- PED
- REACH
- RoHS

Tubos trenzada de PVC Rectusoft

Características técnicas

Presión de trabajo	15 bar, a +23°C
Temperatura de trabajo	-15°C a +60°C
Presión de estallido	63 bar, a +23°C
Materiales	Manguera de PVC de 3 capas, reforzada con textiles, con inserto de hilo de poliéster.

Ventajas

- Bajo peso
- Una flexibilidad muy alta
- Altamente resistente
- Alta resistencia a la presión
- Resistente a los rayos UV
- Larga vida útil
- Resistente a los golpes y a los hilos, no se arruga

Rendimiento de la manguera trenzada de PVC de Legris

PVC alimentario

Presión de trabajo (bar)

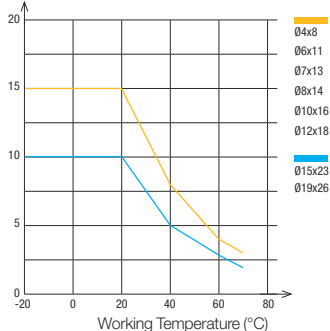

Para calcular las presiones de estallido, los valores de esta tabla se deben multiplicar por 3. Las prestaciones del grado de PVC industrial están disponibles bajo petición.

Tipo de tubo	Ø interior del tubo	Tolerancias sobre Ø interior
PVC alimentario	4 a 6 mm	+0,5 / -0,5
	7 a 12 mm	+0,6 / -0,6
	15 a 19 mm	+0,8 / -0,8
PVC industrial	6,3 mm	+0,3 / -0,3
	9 mm	+0,5 / -0,5
	12,7 mm	+0,6 / -0,6



Embalaje

Rollos: 25 m, 50 m
(con película de plástico de protección)

Tubos de PVC trenzados



1025V Tubo PVC trenzado calidad alimentaria

Rollos 25 m

ØD ext.	ØD int.		 incolore	Kg
8	4	10	1025V08 00 04	1,260
11	6	12	1025V11 00 06	2,253
13	7	14	1025V13 00 07	3,182
14	8	16	1025V14 00 08	3,434
16	10	25	1025V16 00 10	3,800
18	12	30	1025V18 00 12	4,423
23	15	40	1025V23 00 15	7,300
26	19	60	1025V26 00 19	7,300



1050V Tubo PVC trenzado calidad alimentaria

Rollos 50 m

ØD ext.	ØD int.		 incolore	Kg
8	4	10	1050V08 00 04	2,690
11	6	12	1050V11 00 06	4,200
14	8	16	1050V14 00 08	6,058
16	10	25	1050V16 00 10	6,400
18	12	30	1050V18 00 12	8,250
23	15	40	1050V23 00 15	14,600
26	19	60	1050V26 00 19	14,600

1025V..C Tubo PVC trenzado calidad industrial

Rollos 25 m

ØD ext.	ØD int.			Kg
11	6,3	45	1025V11C04 06	2,175
14	9	63	1025V14C04 09	3,250
19	12,7	89	1025V19C04 13	4,975

PVC../050 RECTUSOFT - Mangueras rectas

Rollos 50 m

ØD ext.	ØD int.		Ø de la espira
11	6,3	PVC06/050/03	45
14,5	9	PVC09/050/03	63
19	12,7	PVC12/050/03	89

Productos asociados

Los tubos de PVC se combinan perfectamente con las espiras acanaladas rápidas y los enchufes Parker Legris.

Enchufes

C 9000



Metal



Espiras acanaladas rápidas

0191



0123



Tubo NBR auto-retráctil



Diseñada según la norma CNOMO E07.21.115N* para aplicaciones de procesos de automoción, la manguera de autoapriete se utiliza con espiras acanaladas rápidas.

Legris Ø métrico: 13 a 27 mm

Legris Tubo NBR auto-retráctil

Características técnicas

- **Fluidos adecuados:** Fluidos refrigerantes, aire comprimido
- **Presión de trabajo:** 0 a 16 bar
- **Temperatura de trabajo:** -20°C a +100°C
- **Materiales:** Nitrilo butadieno y trenza textil

Las prestaciones dependen de los fluidos y de los racores utilizados.

Ventajas

- Diseñado para aire comprimido y sistemas de refrigeración, con la máxima velocidad de flujo
- 4 colores para la identificación del circuito
- Resistencia química: UV y el ozono
- Resistencia mecánica: a la flexión repetitiva, llamas y chispas, abrasión y aplastamiento

*IMPORTANTE: la certificación CNOMO es válida únicamente para los tubos de colores rojo y verde, exclusivamente conectados a las espiras acanaladas rápidas Legris, 0132, 0133 y 0134, con certificación CNOMO.

Reglamentaciones

- REACH
- PED
- RoHS

Rendimiento de la manguera Legris de auto-sujeción NBR

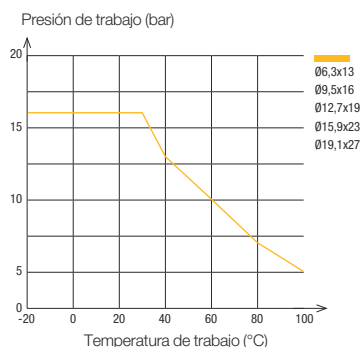

DN mm CNOMO	DN (normalizado)	Ø interior (mm)	Tolerancias sobre Ø interior (mm)
6	1/4"	6,3 mm	+0,4/-0,4
8	3/8"	9,5 mm	+0,5/-0,5
12	1/2"	12,7 mm	+0,6/-0,6
16	5/8"	15,9 mm	
20	3/4"	19,1 mm	

Embalaje
Tambor: 40 m, 80 m, 100 m

Uso con agua: temperatura máxima 100°C
Uso con aire: temperatura máxima 70°C

1040H Tubo auto-retráctil NPR trenzado

Tambor 40 m

DN	ØD ext.	ØD int.	R	Legris	Legris	Legris	Legris	Kg
6	13	6,3	60	1040H56 01	1040H56 02	1040H56 03	1040H56 04	7,000
8	16	9,5	70	1040H60 01	1040H60 02	1040H60 03	1040H60 04	8,500
12	19	12,7	120	1040H62 01	1040H62 02	1040H62 03	1040H62 04	10,000
16	23	15,9	140	1040H66 01	1040H66 02	1040H66 03	1040H66 04	12,000
20	27	19,1	170	1040H69 01	1040H69 02	1040H69 03	1040H69 04	17,500

También disponible bajo demanda en 20 metros

1080H Tubo auto-retráctil NPR trenzado

Tambor 80 m





DN	ØD ext.	ØD int.	R	Legris	Legris	Legris	Legris	Kg
16	23	15,9	140	1080H66 01	1080H66 02	1080H66 03	1080H66 04	26,160
20	27	19,1	170	1080H69 01	1080H69 02	1080H69 03	1080H69 04	33,160

También disponible bajo demanda en 20 metros

Tubo NBR auto-retráctil

1100H Tubo auto-retráctil NPR trenzado

Tambor 100 m

DN	ØD ext.	ØD int.						Kg
6	13	6,3	60		1100H56 02	1100H56 03	1100H56 04	14,660
8	16	9,5	70	1100H60 01	1100H60 02	1100H60 03	1100H60 04	20,000
12	19	12,7	120	1100H62 01	1100H62 02	1100H62 03	1100H62 04	23,000

También disponible bajo demanda en 20 metros

Productos asociados

Los tubos auto-retráctiles se usan perfectamente con las espiras acanaladas rápidas (con certificación CNOMO).

Espiras acanaladas rápidas



Acopladores de moho



Instalación

Referencia de la herramienta: 0650 00 00 05

Herramienta diseñada para insertar una espira acanalada y un tubo autoretráctil.



Corte del tubo y colocación en la herramienta

Cortar el tubo en forma de codo y colocar la espira en el soporte de la herramienta prevista a tal efecto.

Soporte de espira

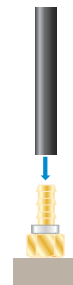

Ajuste a presión del tubo

Accionar la herramienta de ajuste; la conexión es conforme cuando el tubo hace tope en el collarín. Esta herramienta está diseñada para adaptarse a 5 diámetros de tubo distintos y permite una manipulación sencilla, sin esfuerzo.

Oporte de espira



Tubo PU trenzado

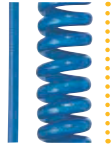

Reforzada por un trenzado que proporciona durabilidad y resistencia a la torsión, la manguera de PVC trenzada también conserva los atributos de un tubo de PU en espiral.

Legris Ø inch: 1/4" a 5/16"
Superbraid Ø métrico: 9,5 a 12 mm

Tubo de PU trenzado

Características técnicas

- **Fluidos adecuados:** Aire comprimido
Otros fluidos: por favor, consúltenos
- **Presión de trabajo:** 0 a 15 bar
- **Temperatura de trabajo:** -40°C a +75°C
- **Materiales:** Poliuretano (85 shore A)

Las prestaciones dependen de los fluidos y de los racores utilizados.

Ventajas

- 3 longitudes disponibles: 3 m, 6 m y 7,5 m
- Resistencia mecánica: abrasión, torsión y aplastamiento
- La remanencia de las bobinas combinada con la flexibilidad del tubo

Reglamentaciones

Industriales:

- PED
- REACH
- RoHS

El rendimiento de los tubos de trenzado PU Recoil Hose

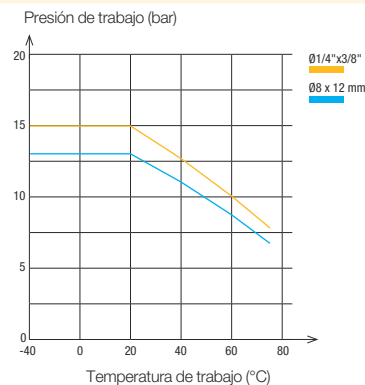

Las prestaciones dependen de los fluidos y de los racores utilizados.

Ø exterior del tubo	Ø interior del tubo	Tolerancias sobre Ø interior
3/8"	1/4"	+/- 0,005"
12 mm	8 mm	

Los tubos Parker Legris garantizan al usuario una perfecta estanqueidad gracias a su calibre del diámetro interior.

Rectus Ultra Lite Superbraid

Características técnicas

- **Presión de trabajo:** 0 a 12 bar
- **Temperatura de trabajo:** -40°C a +75°C
- **Materiales:** Poliuretano

Ventajas

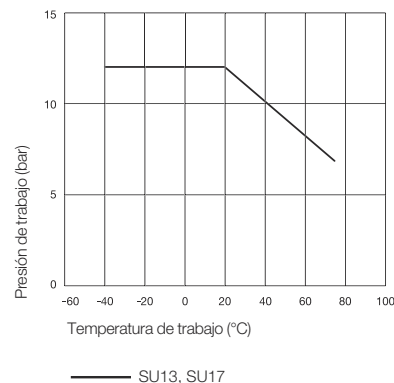

- Altamente resistente a las torceduras, virtualmente sin daños por torsión o aplastamiento
- Extremadamente flexible
- Más ligero que una manguera supertrenzada
- 6 a 10 veces mejor que el caucho o la poliamida

El rendimiento de los tubos del Ultra Lite Superbraid





Tubo PU trenzado

PG../30 SUPERTRENO - Mangueras en espiral de poliuretano (PU) con forro de tela de 3 m, con conector macho BSPP

ØD ext.	ØD int.	C			Longitud de la espiras recogidas	Ø de la espira	Kg
9,5	6,3	G1/4	PG10/030/DV			42	
11,7	7,9	G3/8	PG12/030/DV	1445U12E04 17	880	55	0,300



completamente ensamblado con 2x conexiones de tornillos giratorios niquelados

PG../60 SUPERTRENO - Mangueras en espiral de poliuretano (PU) con forro de tela de 6 m, con conector macho BSPP

ØD ext.	ØD int.	C			Longitud de la espiras recogidas	Ø de la espira	Kg
9,5	6,3	G1/4	PG10/060/DV	1442U60E04 13	1 140	42	0,420
11,7	7,9	G3/8	PG12/060/DV	1442U12E04 17	1 160	55	0,600

completamente ensamblado con 2x conexiones de tornillos giratorios niquelados

PG../75 SUPERTRENO - Mangueras en espiral de poliuretano (PU) con forro de tela 7,5 m, accesorio BSPP macho

ØD ext.	ØD int.	C			Longitud de la espiras recogidas	Ø de la espira	Kg
9,5	6,3	G1/4	PG10/075/DV	1447U60E04 13	1 275	42	0,525
11,7	7,9	G3/8	PG12/075/DV	1447U12E04 17	1 300	55	0,750

completamente ensamblado con 2x conexiones de tornillos giratorios niquelados

SU../25 SUPERTRENO ULTRA-LITE - Manguera recta de poliuretano (PU) 25 m

ØD ext.	ØD int.			Kg
13	9,5	SU13/025/05		1,875
17,4	12,7	SU17/025/05		3,175

Accesorios

3000 71 00 Cortatubos

Polímero técnico

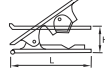

H L Kg

3000 71 00	25	79	0,029
------------	----	----	-------

Este aparato ha sido diseñado para hacer cortes perfectos y a escuadra en los tubos polímeros (poliamida, poliuretano, FEP, polietileno, etc), desde Ø 4 mm hasta 16 mm inclusive.

Cuchilla de recambio: 3000 71 00 05

Un muelle mantiene la cuchilla en posición cerrada para evitar cualquier riesgo de deterioro del aparato.

3000 71 11 Cortatubos

Acero tratado



Kg

3000 71 11	0,280
------------	-------

Cuchilla de recambio: 3000 71 11 05

6000 71 00 Útil de desenfundado

Polímero técnico, acero inoxidable



Kg

6000 71 00	0,098
------------	-------

1827 Refuerzo interior de acero inoxidable para tubo fluoropolímero

Acero inoxidable 316L

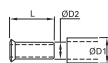

ØD1	ØD2	L	Kg
6	4	1827 06 00	11,5 0,001
8	6	1827 08 00	14 0,001
10	8	1827 10 00	18 0,001
12	9	1827 12 09	18 0,001
12	10	1827 12 00	18 0,001
16	13	1827 16 13	18 0,002
16	14	1827 16 00	18 0,002

Este refuerzo debe utilizarse obligatoriamente con el tubo de Fluoropolímero FEP, a cualquier temperatura o presión que pueda soportar el conjunto de racor + tubo.

0127 Refuerzo interior de latón para tubo polímero

Latón



ØD1	ØD2	L	Kg
4	2	0127 04 00	11 0,001
4	2,7	0127 04 27	11 0,001
5	3	0127 05 03	11 0,001
5	3,3	0127 05 00	11,5 0,001
6	4	0127 06 00	11,5 0,001
8	5,5	0127 08 55	14 0,001
8	6	0127 08 00	14 0,001
10	7	0127 10 07	18 0,001
10	7,5	0127 10 75	18 0,001
10	8	0127 10 00	18 0,002
12	8	0127 12 08	26 0,002
12	9	0127 12 09	18 0,002
12	10	0127 12 00	18 0,001
14	11	0127 14 11	16 0,002
14	12	0127 14 00	18 0,002
15	12	0127 15 12	18 0,002
16	13	0127 16 13	18 0,003
18	14	0127 18 14	19,5 0,003
22	16	0127 22 16	21 0,005

A temperaturas y presiones elevadas, el uso de esta piezas evita que el tubo se retraiga, garantizando un buen agarre.

CLIP Regleta de clips para tubos y racores

Polímero técnico



ØD	H	K	N	K	Kg	
4	CLIP 04 00	9	13,5	10,5	13,5	0,007
6	CLIP 06 00	10,5	13	10,5	13	0,008
8	CLIP 08 00	12,5	10,5	12	10,5	0,007
10	CLIP 10 00	14	12	15	12	0,005
12	CLIP 12 00	16,5	14	16,5	14	0,009
14	CLIP 14 00	18	16	20,5	16	0,009

Suministrado en cajas de 10 regletas de clips del mismo diámetro (con tornillo autorroscante de 9,5 mm de longitud). Estos clips se puede utilizar tanto con tubos métricos como el equivalente pulgadas de tubo.

0697 Abrazadera de apriete para tubo trenzado

Acero tratado

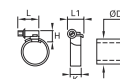

ØD	H	K	L	L1	K	Kg	
6-11	0697 00 01	7	5	12	7	5	0,004
10-16	0697 00 02	12	9	21	13	9	0,011
12-22	0697 00 03	12	9	21	13	9	0,014
16-27	0697 00 04	12	9	24	13	9	0,015
20-32	0697 00 05	12	9	24	13	9	0,016

Accesorios

UR Tuerca roscada

Latón



C	HEX	L
G1/8 droit UR10	12	11
G1/4 droit UR13	17	15,5
G3/8 droit UR17	19	16,5
G1/4 r. f. 9 mm UR13/9*	17	15,5
G1/2 droit UR21	24	20,5

DIN EN 560 (rosca izquierda marcada)
* sólo para STP13/09

STP Cola de manguera, corta

Latón



ØD	C	L
4	G1/8 STP10/04	27,5
6	G1/8 STP10/06	28
4	G1/4 STP13/04	30,5
6	G1/4 STP13/06	35,5
9	G1/4 STP13/09*	35,5
6	G3/8 STP17/06	36
9	G3/8 STP17/09	36
9	G1/2 STP21/09	38
13	G1/2 STP21/13	44

STD Cola de manguera, larga

Latón



ØD	C	L
4	G1/4 STD13/04	47
6	G1/4 STD13/06	47
4	G3/8 STD17/04	47,5
6	G3/8 STD17/06	47,5
9	G3/8 STD17/09	47,5

DIN EN 560

GT La púa de la cola de la manguera

Latón

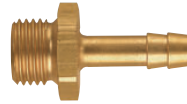

ØD	C	HEX	L
3	M5 GT05/03	7	15,5
4	M5 GT05/04	7	15,5
	M6 GT06/04	8	23
6	G1/2* GT21/06	24	39
4	G1/8* GT10/04	14	28
6	G1/8* GT10/06	14	33
8	G1/8* GT10/08	14	33
9	G1/8* GT10/09	14	33
4	G1/4* GT13/04	17	29,5
6	G1/4* GT13/06	17	34,5
8	G1/4* GT13/08	17	34,5
9	G1/4* GT13/09	17	34,5
10	G1/4* GT13/10	17	34,5
3	G1/4* GT13/13	17	41,5
6	G3/8* GT17/06	19	36
8	G3/8* GT17/08	19	36
9	G3/8* GT17/09	19	36
10	G3/8* GT17/10	19	36
13	G3/8* GT17/13	19	42
9	G1/2* GT21/09	24	39
10	G1/2 GT21/10	24	40
13	G1/2* GT21/13	24	45
16	G1/2 GT21/16	24	53
19	G1/2 GT21/19	24	54
13	G3/4* GT26/13	32	48,5
16	G3/4* GT26/16	32	56,5
19	G3/4* GT26/19	32	56,5
25	G1* GT33/25	36	67,5

con Hilo Macho (* cono interior 45°)

GT La púa de la cola de la manguera

Acero inoxidable

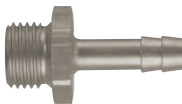

ØD	C	HEX	L	Version
6	G1/8* GT10/06R	14	33	AIISI 303
	G1/8* GT10/06E	14	33	AIISI 316L
9	G1/4* GT13/09R	17	34,5	AIISI 303
	G3/8* GT17/09R	19	36	AIISI 303
13	G1/2* GT21/13R	24	45	AIISI 303

con Hilo macho (* cono interior 45°)

Accesorios

GI La púa de la cola de la manguera

Latón

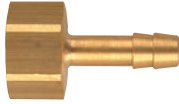

ØD	C		HEX	L
6	G1/8	GI10/06	12	31
8	G1/8	GI10/08	12	31
6	G1/4	GI13/06	17	33
8	G1/4	GI13/08	17	33
9	G1/4	GI13/09	17	33
13	G1/4	GI13/13	17	39
6	G3/8	GI17/06	19	33
8	G3/8	GI17/08	19	33
9	G3/8	GI17/09	19	33
13	G3/8	GI17/13	19	40
6	G1/2	GI21/06	24	36
8	G1/2	GI21/08	24	36
9	G1/2	GI21/09	24	36
13	G1/2	GI21/13	24	43

con Hiló Femenino

DS Reparador de tubos

Latón



ØD		L
4	DS04/04P**	50
6	DS06/06*	72
8	DS08/08*	72
9	DS09/09*	72
13	DS13/13	74

* DIN EN 560

** para las mangueras duras

DK Reparador de tubo, corto

Latón



ØD		L
4	DK04/04	19
6	DK06/06	19

SM Tuerca de tubo para mangueras de plástico

Latón



ØD	C		HEX	L
3 x 4	M7x0.5	SM04	-	8.5
3 x 5	M7x0.6	SM05	-	8.5
4 x 6	M10x1	SM06	12	11
6 x 8	M12x1	SM08	14	11
8 x 10	M16x1	SM10	17	12.5
9 x 12	M16x1	SM12	17	12.5

DV Guardia de resorte giratorio

Latón



ØD	C		HEX
3.1 x 4.7	R1/8	DV10/05	11
4.8 x 6.3	R1/4	DV13/06	14
6.3 x 7.9	R1/4	DV13/08	14
7.9 x 9.5	R1/4	DV13/10	15
9.5 x 11.8	R3/8	DV17/12	19
12.7 x 15.8	R1/2	DV21/16	22

SV Guardia de resorte fijo

Latón



ØD	C		HEX	L
4 x 6	G1/8	SV10/06	12	103
6 x 8	G1/8	SV10/08	12	106
4 x 6	G1/4	SV13/06	17	103
6 x 8	G1/4	SV13/08	17	106
8 x 10	G1/4	SV13/10	17	119
9 x 12	G1/4	SV13/12	17	123
	G3/8	SV17/12*	19	123

* Cono interior 45°

KN Guardia de resorte completamente con Tuerca de Tubo

Latón





ØD	C		HEX	L
4 x 6	M10x1	KN06	12	94
6 x 8	M12x1	KN08	14	97
8 x 10	M16x1	KN10	17	110
9 x 12	M16x1	KN12	17	114

Accesorios

0694 Racor con muelle de protección, rosca macho BSPP

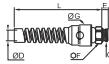
Latón niquelado, NBR



ØD	C		E	F	G	L	Kg
8	G1/4	0694 08 13	6,5	16	24	104,5	0,067
10	G1/4	0694 10 13	6,5	18	24	106,5	0,062
12	G3/8	0694 12 17	7,5	20	29,5	126	0,080

0695 Racor con muelle de protección, rosca macho BSPT

Latón niquelado, NBR

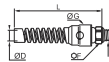

ØD	C		F	G	L	Kg
8	R1/4	0695 08 13	14	24	104,5	0,055
10	R1/4	0695 10 13	18	24	106,5	0,063
12	R3/8	0695 12 17	20	29,5	126	0,090

KB ,O'-Clips



	Ancho de sujeción mm	Altura mm
KB0709	7 - 9	7
KB0911	9 - 11	7
KB1113	11 - 13	7
KB1315	13 - 15	7,5
KB1518	15 - 18	8
KB1720	17 - 20	8,5
KB2023	20 - 23	9

PISTOLAS

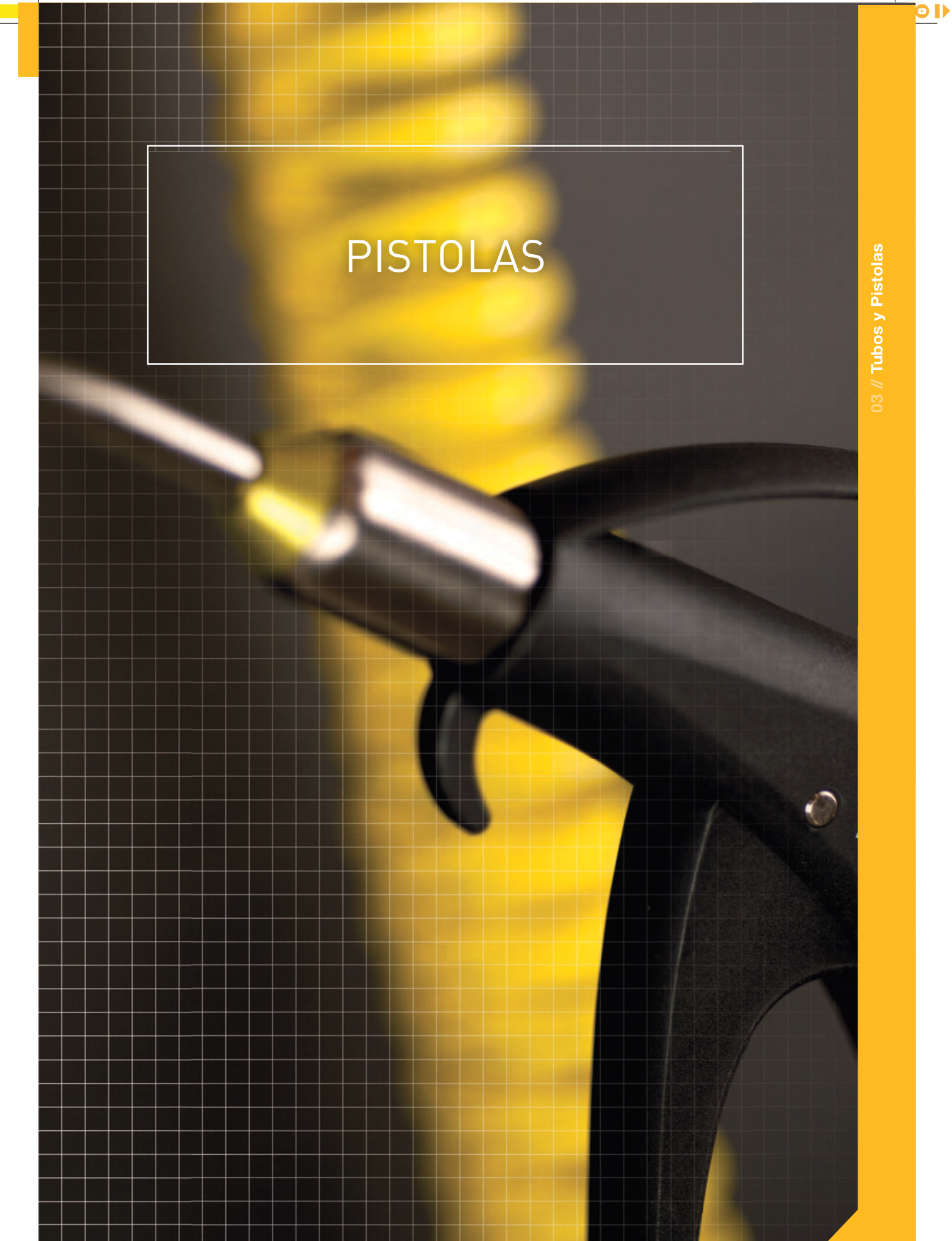

Rango de la pistola

	Materiales	Fluidos	Presión máxima (bar)	Temperaturas		Características	Pagina
				Min.	Max.		
Pistolas Sopladoras Industriales							
Polímeros 	Polímero técnico	Aire comprimido	10	-20°C	+50°C	OSHA	428
Las pistolas con características especiales 	Polímero técnico, latón niquelado	Aire comprimido	10	-20°C	+50°C	Seguridad, seguridad SUVA, ahorro de energía, OSHA	429
Boquillas 	Latón niquelado	Aire comprimido	10	-15°C	+50°C	Un gran número de boquillas para todas sus aplicaciones	430
Metálicas 	Aluminio o latón niquelado	Fluidos industriales	20	-20°C	+100°C	Robustez, ligereza y ergonomía	432
Kits de pistolas 	Polímero técnico	Aire comprimido	10	-20°C	+50°C	Fácil de usar, listo para usar/seguridad y rendimiento	434

Pistolas Estándar



4 gamas de boquillas para adaptarse a las aplicaciones básicas, estándar, de seguridad y de ahorro de energía. Ensambladas o en forma de kit para ofrecer flexibilidad, en polímeros técnicos o metálicos, pueden satisfacer todas las necesidades.

Características técnicas

- **Fluidos adecuados:** Aire comprimido
Otros fluidos: contáctenos
- **Presión de trabajo:** 0 a 10 bar
- **Temperatura de trabajo:** Aire ambiente: -15°C a +50°C
Aire seco: -20°C a +80°C
- **Tubos:** Tubos y mangueras

Ventajas

Pistolas básicas y estándar:

- En cumplimiento de las regulaciones internacionales de ruido y presión
- Boquillas giratorias para chorro direccional
- La tasa de flujo progresivo

Pistolas de seguridad:

- Cumple con las normas de la OSHA y la SUVA según el modelo y se ajusta a ellas:
 - requisitos de exposición al ruido
 - disposiciones relativas a la presión de salida
- Pistolas sopladoras ahorro de energía:
- Flujo limitado para un menor consumo de energía
- Kits y boquillas: para asegurar un producto adecuado

Materiales

Sin silicona



Reglamentaciones

- PED
- RoHS
- REACH
- OSHA
- **DI: 2003/10/CE**

Protección del diseño:

Todas las pistolas Parker Legris se han sometido al registro de los diseños y modelos con los números siguientes:

- 13 224/13 225/13 226

Prescripción relativa a la exposición al ruido, especialmente por el riesgo para el oído. El nivel sonoro debe ser inferior a 87 dbA.

Funcionamiento: Pistola de seguridad



Caudal detenido completamente y presión reducida a 0,5 bar

Funcionamiento: Pistola con boquilla de seguridad



Caudal desviado y presión reducida a 0,5 bar



Caudal máximo
(tolerancia +/-10%)



Nivel sonoro
ISO 15744



Cono
de difusión



Conforme
a las normas

Pistolas Estándar

AK13 Pistola de aire con tubo de extensión de aluminio boquilla fija

Plástico resistente a los impactos



A

Rosca hembra G1/4 **AK13**

boquilla, imposible de reemplazar

AM13 Pistola de aire sin boquilla, Hilo hembra BSPP

Plástico resistente a los impactos



C

C1

G1/4 M12x1.25 **AM13**

AK13SE AK13-Set en la caja de exhibición



A

Rosca hembra G1/4 **AK13SET**

10x AK13 en la caja de exhibición

AJ13 Pistola de aire con tubo de extensión de aluminio, rosca hembra BSPP

Plástico rojo resistente a los impactos



C

tubo

G1/4	AJ13/06B	6mm curvado
G1/4	AJ13/08B	8mm curvado
G1/4	AJ13-300	8 x 300 mm recto
G1/4	AJ13-500	9 x 500 mm recto
G1/4	AJ13-1000	10 x 1000 mm recto

AK26SF Pistola de aire con tubo de extensión de aluminio boquilla fija

Plástico resistente a los impactos



A

Boquillas serie 26 **AK26SF**

0659 Pistola sopladora con boquilla acodada corta conexión inferior, rosca hembra BSPP

Polímero técnico, latón niquelado, aluminio tratado, NBR

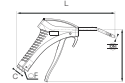

DN

C

F

H

L

Kg

3,5 G1/4 **0659 00 13** 20 120 223 0,108

Boquilla: aluminio

Progresividad del caudal en función de la carrera del gatillo

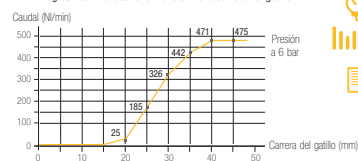

475 Nl/min



82 dBA



OSHA 1910.242 (b)

OSHA 1910.95 (b)

Directiva 2003/10/CE:

Necesidad de utilizar protectores auditivos si la exposición es > 8 horas

Pistolas de polímero de valor añadido

0654 Pistola sopladora de seguridad conexión inferior, rosca hembra BSPP

Polímero técnico, latón niquelado, NBR

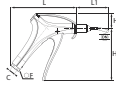

DN	C	F	H	H1	L	L1	Kg
3	G1/4	0654 00 13	20	117	35	148	0,189

Boquilla de latón niquelado, existe también en versión NPT

Progresividad del caudal en función de la carrera del gatillo

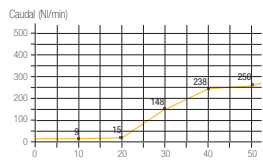

- 250 Nl/min
- 80 dBA
- OSHA 1910.242 (b)
OSHA 1910.95 (b)
Directiva 2003/10/CE:
No es necesario ningún casco auditivo

0654 Pistola sopladora de seguridad SUVA conexión inferior, rosca hembra BSPP

Polímero técnico, latón niquelado, NBR

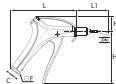

DN	C	F	H	H1	L	L1	Kg
3	G1/4	0654 01 13	20	117	35	148	0,189

Boquilla de latón niquelado, existe también en versión NPT

Progresividad del caudal en función de la carrera del gatillo

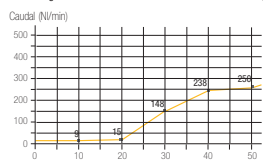

- 250 Nl/min
- 80 dBA
- OSHA 1910.242 (b)
OSHA 1910.95 (b)
Directiva 2003/10/CE:
No es necesario ningún casco auditivo

0653 Pistola sopladora ahorro de energía con boquilla intercambiable conexión inferior, rosca hembra BSPP

Polímero técnico, latón niquelado, NBR

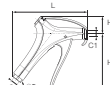

C	C1	F	H	H1	L	L1	Kg
G1/4	M12x1.25	0653 66 13	20	117	34	147	0,144

Las características del flujo dependen del tipo de boquilla utilizada, entregada sin boquilla. Se dispone de una calculadora de ahorro de energía.

Progresividad del caudal en función de la carrera del gatillo

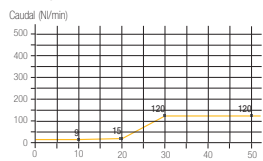

- 120 Nl/min
- 80 dBA
- Con todos los tipos de boquillas
- Nivel sonoro medido sin boquilla
- OSHA 1910.242 (b):
Depende del tipo de boquilla
OSHA 1910.95 (b)
Directiva 2003/10/CE:
No es necesario ningún casco auditivo

0652 Pistola sopladora con boquilla intercambiable conexión inferior, rosca hembra BSPP

Polímero técnico, latón niquelado, NBR

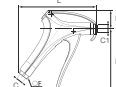

C	C1	F	H	H1	L	L1	Kg
G1/4	M12x1.25	0652 66 13	20	117	34	147	0,163

Las características de caudal dependen del tipo de boquilla utilizado. Se suministra sin boquilla.

- Depende del tipo de boquilla
- 86 dBA
- Nivel sonoro medido sin boquilla
- OSHA 1910.242 (b):
Depende del tipo de boquilla
OSHA 1910.95 (b)
Directiva 2003/10/CE:
Necesidad de utilizar protectores auditivos si la exposición es > 6 horas

0651 Pistola sopladora con boquilla estándar conexión inferior, rosca hembra BSPP

Polímero técnico, latón niquelado, NBR

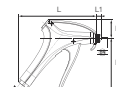

DN	C	F	H	H1	L	L1	Kg
2,5	G1/4	0651 66 13	20	117	34	147	0,168

Boquilla de latón niquelado

Progresividad del caudal en función de la carrera del gatillo

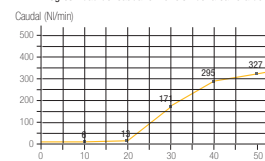

- 327 Nl/min
- 86 dBA
- Caudal realizado con boquilla 0690 01 00
- OSHA 1910.95 (b)
Directiva 2003/10/CE:
Necesidad de utilizar protectores auditivos si la exposición es > 6 horas

0656 Pistola sopladora con boquilla acodada corta de seguridad conexión inferior, rosca hembra BSPP

Polímero técnico, latón niquelado, NBR

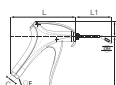

DN	C	F	H	H1	L	L1	Kg
2,5	G1/4	0656 66 13	20	117	34	147	0,173

Boquilla de latón niquelado

Progresividad del caudal en función de la carrera del gatillo

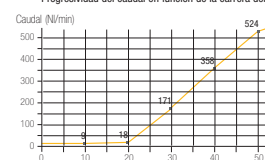

- 524 Nl/min
- 86 dBA
- Caudal realizado con boquilla 0690 06 01
- OSHA 1910.242 (b)
OSHA 1910.95 (b)
Directiva 2003/10/CE:
Necesidad de utilizar protectores auditivos si la exposición es > 6 horas

Boquillas para pistolas de polímero

0690 01 Boquilla estándar

Latón niquelado



DN	C		G	L	L1	Kg
2,5	M12x1.25		15	31	9	0,023



- Polivalencia de uso
- Chorro de aire direccional potente y progresivo

 327 N/min

 86 dBA

 23°

 OSHA 1910.95 (b) /
Directiva 2003/10/CE:
Necesidad de utilizar protectores auditivos
si la exposición es > 8 horas

0690 04 Boquilla recta corta de seguridad

Latón niquelado, NBR

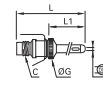

DN	C		G	L	L1	Kg
2,5	M12x1.25		15	102	77	0,034



- Accesos difíciles
- Efecto pantalla de aire y chorro direccional
- Seguridad: evita la obturación completa de la boquilla

 410 N/min

 82 dBA

 21°

 OSHA 1910.242 (b) / OSHA 1910.95 (b) /
Directiva 2003/10/CE:
Necesidad de utilizar protectores auditivos
si la exposición es > 8 horas

0690 02 Boquilla de seguridad

Latón niquelado



DN	C		G	L	L1	Kg
2,5	M12x1.25		15	31	9	0,024



- Fluidificación de sustancias pulverulentas
- Efecto pantalla de aire
- Seguridad: evita la obturación completa de la boquilla

 315 N/min

 83 dBA

 26°

 OSHA 1910.95 (b) / OSHA 1910.242 (b) /
Directiva 2003/10/CE:
Necesidad de utilizar protectores auditivos
si la exposición es > 8 horas

0690 05 Boquilla acodada larga

Latón niquelado, NBR

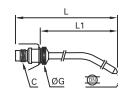

DN	C		G	L	L1	Kg
2,5	M12x1.25		15	316	292	0,065



- Accesos difíciles o alejados
- Chorro de aire direccional potente y progresivo
- Rotación 360°

 354 N/min

 82 dBA

 21°

 OSHA 1910.95 (b) /
Directiva 2003/10/CE:
Necesidad de utilizar protectores auditivos
si la exposición es > 8 horas

0690 03 Boquilla recta larga

Latón niquelado, NBR

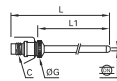

DN	C		G	L	L1	Kg
2,5	M12x1.25		15	332	307	0,067



- Accesos difíciles
- Chorro de aire direccional potente y progresivo

 386 N/min

 82 dBA

 21°

 OSHA 1910.95 (b) /
Directiva 2003/10/CE:
Necesidad de utilizar protectores auditivos
si la exposición es > 8 horas

0690 06 Boquilla acodada corta de seguridad

Latón niquelado, NBR

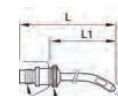

DN	C		G	L	L1	Kg
2,5	M12x1.25		15	94	70	0,033

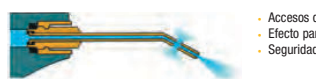

- Accesos difíciles
- Efecto pantalla de aire y chorro direccional 360°
- Seguridad: evita la obturación completa de la boquilla

 350 N/min

 86 dBA

 21°

 OSHA 1910.242 (b) / OSHA 1910.95 (b) /
Directiva 2003/10/CE:
Necesidad de utilizar protectores auditivos
si la exposición es > 8 horas

Boquillas para pistolas de polímero

0690 06 01 Boquilla acodada corta

Latón niquelado, NBR



DN	C		G	L	L1	Kg
2,5	M12x1,25	0690 06 01	15	94	70	0,035



- Accesos difíciles
- Chorro direccional potente y progresivo, rotación 360°



524 Nl/min



86 dBA



21°



OSHA 1910.95 (b)
Directiva 2003/10/CE:
Necesidad de utilizar protectores auditivos
si la exposición es > 8 horas

0690 08 Boquilla COANDA

Latón niquelado



C		L	L1	Kg
M12x1,25	0690 08 00	47,5	26	0,033

La boquilla no es compatible con las cerbatanas Rectus



- Chorro de aire direccional
- Muy silencioso, con ahorro de energía
- Seguridad: evita la obturación completa de la boquilla



240 Nl/min



73 dBA



20°



OSHA 1910.242 (b) / OSHA 1910.95 (b)
Directiva 2003/10/CE:
No es necesario ningún casco auditivo

0690 07 Boquilla de conexión instantánea LF 3000®

Latón niquelado, NBR



ØD	C		G	L	L1	Kg
4	M12x1,25	0690 07 00	15	35	13	0,024



- Accesos difíciles
- Chorro de aire potente y progresivo



340 Nl/min (tubo 2,7x4)
200 Nl/min (tubo 2x4)



86 dBA



21°



OSHA 1910.95 (b)
Directiva 2003/10/CE:
Necesidad de utilizar protectores auditivos
si la exposición es > 8 horas

0690 10 Boquilla VENTURI de seguridad

Latón niquelado

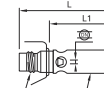

DN	C		G	L	L1	Kg
2,5	M12x1,25	0690 10 00	15	64	42	0,038



- Gran caudal de aire para soplado de grandes superficies
- Efecto pantalla de aire
- Seguridad: evita la obturación completa de la boquilla



780 Nl/min



99 dBA



28°



OSHA 1910.242 (b)
Directiva 2003/10/CE:
Necesidad de utilizar protectores auditivos
de manera permanente

0690 09 Boquilla de seguridad con pantalla de aire

Latón niquelado



DN	C		G	L	L1	Kg
2	M12x1,25	0690 09 00	30	40,5	18,5	0,021

Deflector de polímero técnico



- Gran caudal de aire para soplado de grandes superficies
- Pantalla de aire y deflector que evita la retroproyección de partículas
- Seguridad: evita la obturación completa de la boquilla



660 Nl/min



86 dBA



Conducto 24°
Pantalla 140°



OSHA 1910.242 (b) / OSHA 1910.95 (b)
Directiva 2003/10/CE:
Necesidad de utilizar protectores auditivos
si la exposición es > 8 horas

0690 11 Boquilla VENTURI con pantalla de aire de seguridad

Latón niquelado

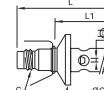

DN	C		G	G1	L	L1	Kg
2,5	M12x1,25	0690 11 00	30	15,0	76	54	0,045

Deflector de polímero técnico



- Misma ventaja que la boquilla con efecto VENTURI
- Seguridad: evita la obturación completa de la boquilla
- Pantalla de aire y deflector que evita la retroproyección de partículas



860 Nl/min



99 dBA



Conducto 26°
Pantalla 140°



OSHA 1910.242 (b)
Directiva 2003/10/CE:
Necesidad de utilizar protectores auditivos
de manera permanente

Pistolas metálicas



Esta gama de robustas boquillas garantiza una mayor vida útil en condiciones severas (aplastamiento, impacto, choque y corrosión). Incluye dos versiones para soplar y pulverizar en aplicaciones industriales.

Características técnicas

Modelo	Pistola de taller	Pistola de riego
Fluidos adecuados	Aire comprimido y fluidos industriales	Aceite, agua y fluidos industriales
Presión de trabajo	0 a 10 bar	0 a 20 bar
Temperatura de trabajo	Aire ambiente: -15°C a +50°C Aire seco: -20°C a +80°C	-20°C a +100°C
Tubos	Mangueras y tubos	Tubos trenzados con acopladores Parker

Reglamentaciones

- PED
- REACH
- RoHS

Materiales

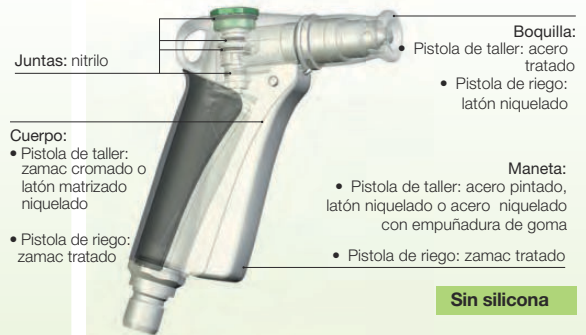

Ventajas

Pistola de taller

- Compacto
- Latón forjado niquelado para aumentar la resistencia a la corrosión

Pistola de riego

- La transmisión de agua y fluidos
- Diseñado para el control preciso del flujo y la optimización de la potencia y la forma del chorro
- Uso óptimo de los fluidos industriales

AA13S-01 Pistola sin boquilla, rosca hembra BSPP pero compatible con las boquillas de la página anterior

Aluminio



C 

G1/4 AA13S-01

Aluminio

AS13 Pistola de aire con boquilla de seguridad, rosca hembra BSPP

Aluminio



C 

G1/4 AS13

AA13 Pistola de aire con boquilla estándar, rosca hembra BSPP

Aluminio



C 

G1/4 AA13

AV13 Pistola de aire con tubo de extensión, rosca BSPP femenino

Aluminio



C 

G1/4 AV13

Pistolas metálicas

0623 Pistola de taller con palanca, rosca hembra BSPP

Latón niquelado, acero cementado zincado, NBR

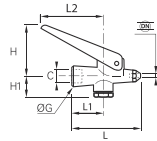

DN	C		G	H1	H max	H min	L	L1	L2	Kg	
2	G1/4		0623 10 35	18	21	37	19	64	28	60	0,119

Esta pistola de taller se compone de un surtidor calibrado de acero tratado.

0622 Pistola de taller con botón, rosca hembra BSPP

Latón niquelado, acero cementado zincado, NBR

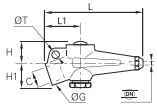

DN	C		G	H	H1	L	L1	T	Kg	
2	G1/4		0622 26 73	18	17,5	20,5	82	29	7	0,199

Esta pistola de taller se compone de un surtidor calibrado de acero tratado.

2299 Pistola para riego

Zamac, latón niquelado, NBR

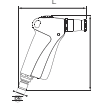

DN			H	L	Kg
12		2299 12 01	140	126	0,470

Esta pistola permite regular de manera independiente:

- el flujo (disparador) hasta 1440 NI/min (aire) y hasta 16,2 NI/min (agua)
 - la forma del chorro (hasta la atomización fina) por la boquilla de su manguera zamac, latón niquelado, NBR
- Pistola compatible con los acoplamientos de la serie Midi mostrados en la página 381

2299 Manguera de riego

Latón niquelado, NBR



DN			L	Kg
12		2299 12 20	77,4	0,137

La forma del chorro de pulverización de esta manguera es regulable.

Pistolas de polímero



Ergonómico, el Kit de Pistolas sigue siendo un elemento esencial para la operación de soplado o pulverización en el entorno industrial.

Características técnicas

- **Fluidos adecuados:** Aire comprimido
Otros fluidos: consútenos
- **Presión de trabajo:** 0 a 10 bar
- **Temperatura de trabajo:** Aire ambiente: -15°C a +50°C
Aire seco: -20°C a +80°C
- **Tubos:** Tubos en espiral

Reglamentaciones

- **PED**
 - **RoHS**
 - **REACH**
- Protección del diseño:
Todas las pistolas Parker Legris se han sometido al registro de los diseños y modelos con los números siguientes:
- **13 224/13 225/13 226**
 - **OSHA**
 - **DI: 2003/10/CE**
- Prescripción relativa a la exposición al ruido, especialmente por el riesgo para el oído. El nivel sonoro debe ser inferior a 87 dbA.

Materiales



Ventajas

- Composición del kit:
- una pistola
 - un tubo en espiral de 4 metros
 - un racor roscado R1/4, diámetro externo 8 mm
- Seguridad
Optimización de su consumo de energía
Caída de presión mínima

0631..09 Kit pistola estándar conexión inferior, rosca macho BSPT

Polímero técnico, latón niquelado, aluminio tratado, NBR

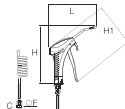

C	F	H	H1	L	Kg
R1/4 0631 00 09	16	192,5	139,5	152	0,441

Características de caudal, de nivel sonoro y de conformidad con las reglamentaciones idénticas a las de las pistolas (0659 00 13).

0631..23 Kit pistola ahorro de energía con boquilla acodada corta de seguridad, rosca macho BSPT

Polímero técnico, latón niquelado, NBR

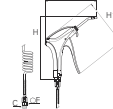

C	F	H	H1	L	Kg
R1/4 0631 00 23	16	195	148,5	163	0,456

Características de caudal, de nivel sonoro y de conformidad con las reglamentaciones idénticas a las de las pistolas (0653 02 13).

0631..01 Kit pistola de seguridad conexión inferior, rosca macho BSPT

Polímero técnico, latón niquelado, NBR

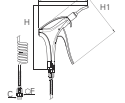

C	F	H	H1	L	Kg
R1/4 0631 00 01	16	198,5	148,5	154	0,575

Características de caudal, de nivel sonoro y de conformidad con las reglamentaciones idénticas a las de las pistolas (0654 00 13).

0631..05 Kit pistola conexión inferior con boquilla acodada corta, rosca macho BSPT

Polímero técnico, latón niquelado, NBR

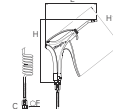

C	F	H	H1	L	Kg
R1/4 0631 00 05	16	195,5	148,5	163	0,536

Características de caudal, de nivel sonoro y de conformidad con las reglamentaciones idénticas a las de las pistolas (0656 66 13).

Pistolas de polímero

0631..07 Kit pistola conexión inferior con boquilla intercambiable, rosca macho BSPT

Polímero técnico, latón niquelado, NBR

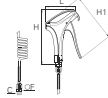

C		F	H	H1	L	Kg
R1/4	0631 00 07	16	163	148,5	91	0,617

Características de caudal, de nivel sonoro y de conformidad con las reglamentaciones idénticas a las de las pistolas (0656 66 13).
Se suministran sin boquilla.

#04

Válvulas industriales

De cierre esférico

LIQUIfit®

De punzón y lenticular

Válvulas axiales



La solución para sus necesidades

¿Como elegir sus válvulas de bola?

¿Qué tipo de válvula necesitas?

- De cierre esférico

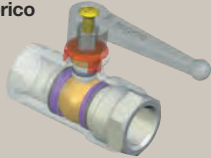

- De punzón



- Lenticular



Representa una interesante alternativa económica en comparación con una válvula de bola

- Válvulas axiales



¿Cuáles son las condiciones de uso?

- Presión
- La temperatura dentro del sistema
- Requisitos de sellado
- Requisitos de flujo
- 2 vías o 3 vías
- Normalmente cerrado / Normalmente abierto?

¿Qué tipo de fluido se está transportando?

- Compatibilidad de los materiales con el fluido: cuerpo y sellos

¿Qué tecnología se requiere para conectar sus válvulas de bola?

- Compresión
- Hilo de rosca
- Conexión Push-in

¿Ha considerado los requisitos adicionales del producto?

- Racores de compresión de anillo
- Tubos
- Válvulas de solenoide

¿Cuál es su entorno de aplicación?

- Entorno interno o externo
- Riesgo de choques
- La calidad del aire
- Reglamento
- Riesgo de corrosión
- Frecuencia de funcionamiento

¿Qué otras funciones se requieren?

- Bloqueable
- Ventilación
- Frecuencia de funcionamiento
- Eléctrico o neumático

Identificación de nuestras referencias

0402 04 10

Tipo de válvula	Longitud	Rosca
0400	04 = 4 mm	10 = 1/8"
0401	05 = 5 mm	13 = 1/4"
0402
...	40 = 40 mm	48 = 2"

Descripción de las especificaciones del producto

	Materiales	Fluidos	Presión máxima (bar)	Temperaturas		Pagina
				Min.	Max.	
Válvulas						
Serie universal y semi-especial, de cuerpo esférico 	Latón matrizado niquelado	Aire comprimido Otros fluidos (ver tabla de compatibilidad en este capítulo)	40	-40°C	+80°C 100°C: consúltenos	444
Serie universal con purga 	Latón matrizado niquelado	Aire comprimido Otros fluidos (ver tabla de compatibilidad en este capítulo)	40	-20°C	+80°C	447
Serie universal precintable 	Latón matrizado niquelado, sistema de bloqueo de acero zincado y epoxi	Aire comprimido Otros fluidos (ver tabla de compatibilidad en este capítulo)	40	-40°C	+80°C	448
Serie universal ligera 	Latón matrizado crudo o niquelado	Aire comprimido Otros fluidos (ver tabla de compatibilidad en este capítulo)	20	-20°C	+80°C	449
Serie DVGW, de cuerpo esférico 	Latón niquelado	Aire comprimido Otros fluidos (ver tabla de compatibilidad en este capítulo)	40	-40°C	+170°C	451
Serie estándar, de cuerpo esférico 	Latón niquelado o cromado	Aire comprimido Otros fluidos (ver tabla de compatibilidad en este capítulo)	30	-20°C	+130°C	452
Serie acero inoxidable, de cuerpo esférico 	Acero inoxidable 316L	Todos los fluidos	35	-20°C	+150°C	454
Cierre esférico, serie alta presión 	Latón zincado	Aire comprimido, lubricantes, gases	300	-15°C	+80°C	456
Cierre esférico, serie mini 	Polímero técnico/ Latón niquelado	Aire comprimido	10	-20°C	+80°C	457
LIQUIfit® Cierre esférico 	Polipropileno	Bebidas, agua, fluidos industriales, CO ₂ , gases neutros	10	-15°C	+100°C	459
De punzón de latón 	Latón matrizado granallado niquelado	Aire comprimido, agua, fluidos industriales Otros fluidos: por favor, contáctenos	120	-20°C	+100°C	461
Serie de punzón de acero inoxidable 	Acero inoxidable 316L	Todos los fluidos	400	-20°C	+180°C	460
Válvula lenticular 	Latón matrizado granallado niquelado	Aire comprimido, fluidos abrasivos	16	-20°C	+80°C	462
Válvulas axiales 	Latón niquelado	Aire comprimido, agua, fluidos industriales Otros fluidos: por favor, contáctenos	10	-20°C	+135°C	463

Tabla de compatibilidad

El siguiente cuadro muestra la compatibilidad entre las válvulas y los fluidos junto con sus características de presión y temperatura. Ciertos modelos tienen una presión máxima de trabajo que difiere de la indicada en esta tabla. En este caso, la presión se muestra en el encabezado del número de modelo en cuestión.

N.B.: Por encima de 32 mm o 1¼" de diámetro, divida la presión máxima por 2.

Si el fluido que está usando no se muestra en esta tabla, por favor contáctenos.

Denominación de los productos	Presión máx. (bar)	Temperaturas en °C		Serie universal y serie ligera	Serie estándar	Serie DVGW
		Min.	Max.			
Aceite (de petróleo) y agua emulsiones	40	-20	+90	●	●	●
Aceite de castor	40	-20	+90	●	●	
Aceite de colza	40	-20	+90	●	●	
Aceite de corte	40	-20	+90	●	●	
Aceite de parafina	40	-20	+90	●	●	●
Aceite de petróleo mineral	20	-20	+160			
Aceite de pie de buey	40	-20	+90	●	●	●
Aceite de ricino	40	-20	+90	●	●	●
Aceite de vaselina	40	-20	+90	●	●	●
Aceites "sintéticos"	20	-20	+100			
Aceites comestibles	20	+5	+200		●	
Aceites Diésel	40	-20	+90	●	●	
Aceites hidráulicos (de petróleo)	40	-20	+90	●	●	
Aceites minerales	40	-20	+90	●	●	●
Acetil - Acetona	20	-20	+60			
Acetileno (gas)	20	-20	+60	●	●	●
Acetofenona	20	-20	+60			
Acetona y otras cetonas	20	-20	+60			
Agua a alta temperatura	20		+150			●
Agua cargada con gas carbónico	40		+90	●	●	●
Agua de mar	40		+80	●	●	●
Agua de mar muy caliente	20		+150			●
Agua destilada	40		+90	●	●	●
Agua normal	40		+80	●	●	●
Agua oxigenada	40	-20	+30			
Aire comprimido	20	-25	+180	●	●	●
Alcohol absoluto	20	-20	Ebullic.			
Alcohol Amílico	20	-20	Ebullic.			
Alcohol bencílico	20	-20	Ebullic.			
Alcohol butílico	20	-20	Ebullic.			
Alcohol de quemar o desnaturalizado	40	-20	+40	●	●	●
Alcohol diacetónico	20	-20	Ebullic.			
Alcohol etílico	20	-20	Ebullic.			
Alcohol graso	20	-20	Ebullic.			
Alcohol isopropílico	20	-20	Ebullic.			
Alcohol metílico	20	-20	Ebullic.			
Alcohol propílico	20	-20	Ebullic.			

Las recomendaciones anteriores se dan de buena fe. Sin embargo, dado que cada aplicación es diferente, es aconsejable realizar las pruebas en condiciones de trabajo reales.

Tabla de compatibilidad

Denominación de los productos	Presión máx. (bar)	Temperaturas en °C		Serie universal y serie ligera	Serie estándar	Serie DVGW
		Min.	Max.			
Almidón (geles o pastas)	40	+10	+40	●	●	●
Alúmina (en suspensión líquida, pastosa)	40	-20	+90	●	●	●
Animales (aceites, grasas)	20	+5	+200		●	●
Anticongelantes o glicol (diluidos)	40	-20	+40	●	●	●
Argón (gas) Ar	20	-20	+60	●	●	●
Automóvil (líquidos de frenos)	20	-20	+90			
Bario - Hidróxido	20	-20	+40			
Barnices y pinturas	20	-20	+60		●	●
Benceno	20	-20	+60			
Bencil - Alcohol	20	-20	Ebullic.			
Benzaldehído	20	-20	+60			
Bórax (pastas o licores)	20	-20	+60			
Bromocloro-Trifluoroetano	20	-20	+60		●	●
Butadieno (hidrocarburos)	20	-20	+60			
Butano	20	-20	+60	●	●	●
Butanol	20	-20	Ebullic.			
Buteno (hidrocarburos)	20	-20	+60			
Caldo bordelés (insecticidas)	20	0	+40	●	●	●
Carbonato sódico (con agua)	20	0	+40	●	●	●
Ceras naturales (vegetales, de abeja, de carnauba, de China, de lignito)	40	-20	+90			
Creosotas	20	-20	+60			
Cresoles	20	-20	+60			
Decalina (hidrocarburos, disolventes)	20	-20	+60			
Detergentes (soluciones)	20	-20	+100			
Di-Ésteres	20	-20	+90			
Di-Fenil-Óxido (detergentes ajustados)	20	-20	+60			
Di-Iso-Butileno	20	-20	+60			
Di-Pentano	20	-20	+60			
Di-Penteno (disolventes, barnices)	20	-20	+60			
Estireno (ver Butadieno)	20	-20	+60			
Etano (gas hidrocarburo)	20	-20	+60			
Etano (gas) CH ₂ CH ₃	20	-20	+60	●	●	
Etanodiol (anticongelantes) ver glicol	20	-20	+120			
Etil-Alcohol	20	-20	+60			
Etilenos-Glicol (anticongelantes)	20	-20	+120			
Feno	20	-20	+60			
Fenol (soluciones acuosas o alcohólicas)	20	-20	+60		●	●
Fueloil	40	-20	+40	●	●	●
Fueloil-Gasoil	40	-20	+40	●	●	
Gas carbónico CO ₂	40	-20	+60	●	●	
Gas de alumbrado	20	-20	+40			●
Gas natural	20	-20	+40			●
Gasolina normal	20	-20	+40	●	●	

Todos las indicaciones anteriores, son fruto de nuestra experiencia. A pesar e ello, al ser cada aplicación un caso particular, no podemos responsabilizarnos por lo que recomendamos que antes de su uso definitivo, se efectúen ensayos previos en las condiciones reales de utilización.

Tabla de compatibilidad

Denominación de los productos	Presión máx. (bar)	Temperaturas en °C		Serie universal y serie ligera	Serie estándar	Serie DVGW
		Min.	Max.			
Gasolina Súper	20	-20	+40			
Glicerina	20	-20	+40	●	●	
Glicol (para anticongelantes, lubricantes)	40	-20	+40	●	●	
Grafito en suspensión en agua, aceites, grasas	40	-20	+90	●	●	
Grasas (de petróleo)	40	-20	+90	●	●	
Grasas comestibles	20	+5	+200		●	
Helio (gas)	20	-20	+60			
Heptanal	20	-20	+50	●	●	
Hexano (disolvente)	20	-20	+60			
Hidrocarburos "aromáticos"	20	-20	+60			
Hidrógeno gas	20	-20	+60			
Iso-butano (hidrocarburos alifáticos)	20	-20	+60			
Iso-Octano	20	-20	+60			
Jabones	20	-20	+100			
Jabones líquidos o pastosos	40	-20	+40	●	●	●
Kriptón Kr (gas)	20	-20	+60	●	●	●
Líquidos saponificantes	20	-20	+30	●	●	●
Metano (gas) CH ₄	20	-20	+60	●	●	●
Metanol	20	-20	Ebullic.			
Metil - Alcohol (disolventes)	20	-20	Ebullic.			
Neón (Gas) Ne	20	-20	+60	●	●	●
Nitrógeno (gas) N ²	40	-20	+90	●	●	●
Oxígeno gaseoso (ambiente)	20	-20	+40			
Parafinas	20	-20	+60	●	●	●
Pentano (hidrocarburos líquidos)	20	-20	+60	●	●	●
Pentanoles 1 y 2	20	-20	Ebullic.			
Pentil - Alcohol	20	-20	Ebullic.			
Petróleo crudo	20	-20	+40			
Pinturas y sus disolventes	20	-20	+60		●	●
Propano	20	-20	+60	●	●	●
Propanoles 1 y 2	20	-20	Ebullic.			
Propanona 2	20	-20	+60			
Propeno o Propileno	20	-20	+60			
Propileno o Propeno	20	-20	+60			
Tintas	20	-20	+60			
Tolueno (hidrocarburos terpénicos)	20	-20	+60		●	●
Trementina	20	-20	+50	●	●	●

Todas las indicaciones anteriores, son fruto de nuestra experiencia. A pesar e ello, al ser cada aplicación un caso particular, no podemos responsabilizarnos por lo que recomendamos que antes de su uso definitivo, se efectúen ensayos previos en las condiciones reales de utilización.

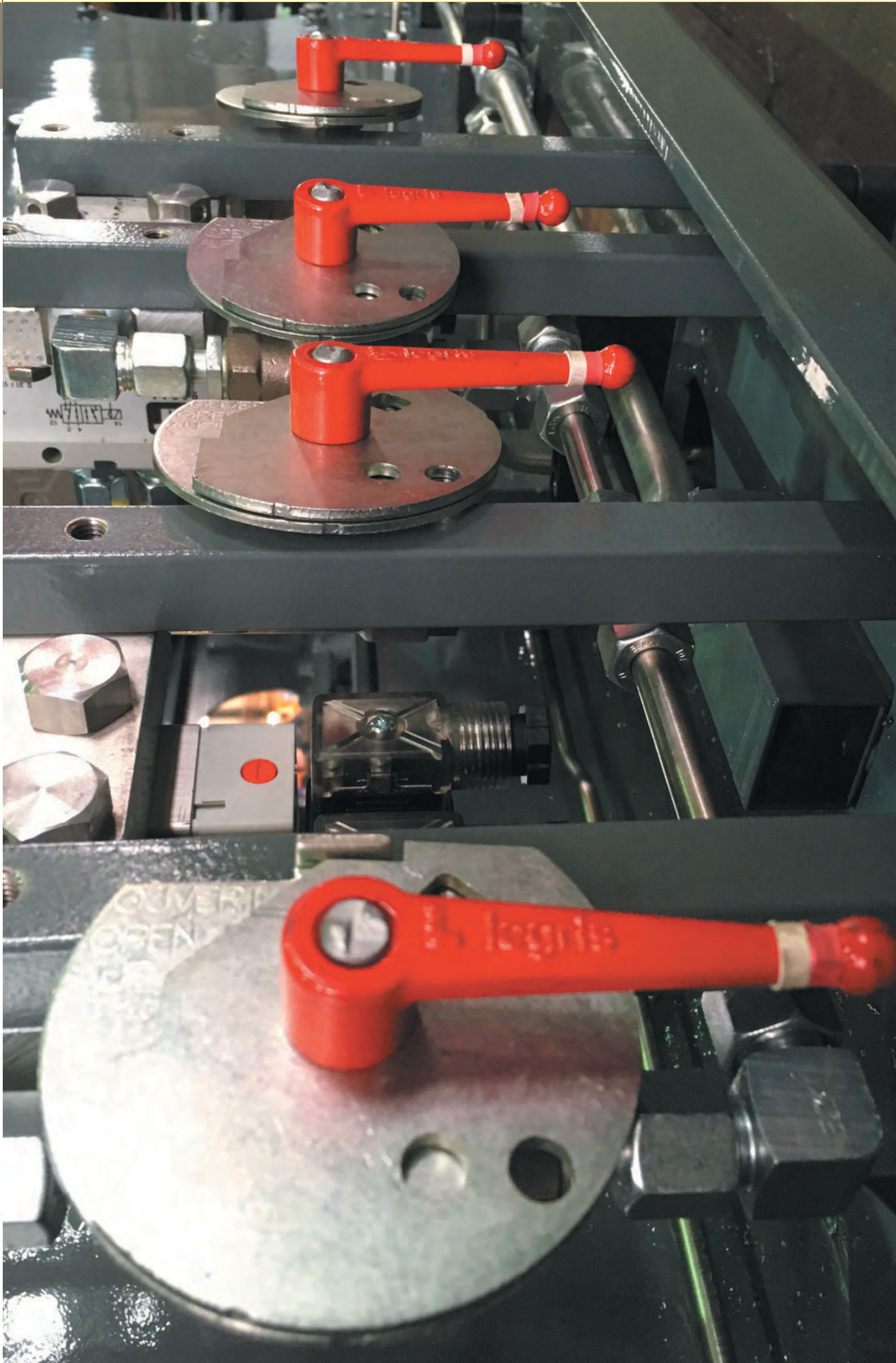

Serie universal



La tecnología de compensación del desgaste del sello ofrece un sellado fiable y duradero, ya sea bajo presión o en vacío.

Características técnicas

- **Fluidos adecuados:** Aire comprimido
Otros fluidos: ver tabla de compatibilidad al principio de este capítulo
- **Presión de trabajo:** De vacío hasta 40 bar, dependiendo del modelo
- **Temperatura de trabajo:** -40°C a + 80°C

Las prestaciones dependen de los fluidos utilizados.
El uso está garantizado para un vacío de 755 mm Hg (99 % de vacío).

Ventajas

- Compensación automática del desgaste de la junta
- Resistencia al vacío
- Facilidad de funcionamiento
- Manetas cortas, reposicionables e intercambiables

Materiales

Sin silicona

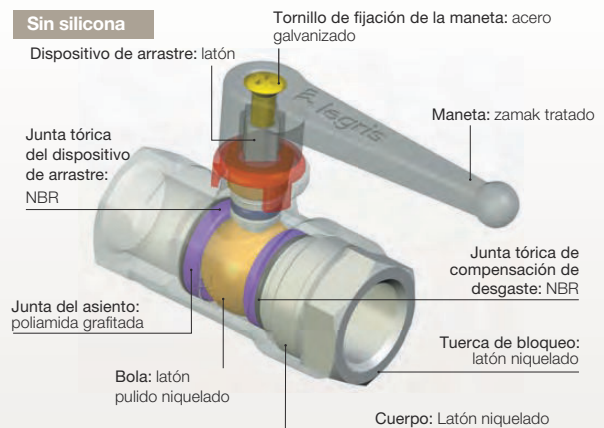

Reglamentaciones

- PED
- REACH
- RoHS

Configuraciones de instalación

Válvulas precintables

Para responder a peligros relacionados con operaciones involuntarias, la platina bloqueable solidaria del dispositivo de arrastre garantiza la conformidad con la norma de seguridad ISO 4414.

El bloqueo se realiza:

- en 1 punto: modelos 0432 y 0439
- o bien en 1, 2 o 3 puntos: modelos 0436, 0437 y 0438

Válvulas de purga

Para detener la circulación del fluido y purgar el circuito, 2 sistemas de purga son disponibles:

- purga con rosca, permite recoger los escapes
- purga libre, utilizable en todos los casos en los que no haya exigencias particulares

Un marcado del sentido del fluido señala el sentido de montaje.

Válvulas con fijación: instalación

Sobre placa de chapa:

- fijación en pasatabiques
- fijación mediante tornillo posterior

Sobre bastidor:

- fijación por espárragos

Sobre panel de madera:

- fijación con tornillos

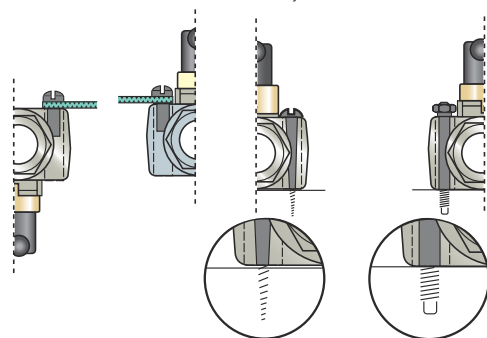

0400 Válvula recta 2/2, rosca macho BSPP

Latón niquelado, NBR

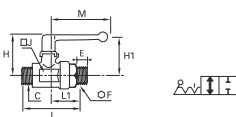

DN	C	E	F	H	H1	J	L	L1	M	Kg	
4	G1/8	0400 04 10	7	14	35	29	14	45	25	48	0,094
7	G1/4	0400 07 13	9	19	38	31	19	60	36	48	0,166
10	G3/8	0400 10 17	11	24	45	43	24	70	43	69	0,252
13	G1/2	0400 13 21	12	27	47	44	27	78	45	69	0,324
18	G3/4	0400 18 27	12	38	63	54	39	90	50	108	0,714

Presión máx de servicio: 40 bar

0411 Válvula recta 2/2 con anillo de cierre de acero

Latón niquelado, NBR

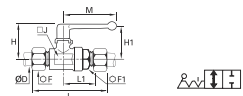

DN	ØD	F	F1	H	H1	J	L	L1	M	Kg	
4	6	0411 04 06	14	19	38	31	19	76	30	48	0,173
6	8	0411 06 08	17	19	38	31	19	77	30	48	0,195
7	10	0411 07 10	19	19	38	31	19	78	31	48	0,210
10	12	0411 10 12	22	24	45	43	24	85	36	69	0,310

Presión máx de servicio: 40 bar

Serie universal

0402 Válvula recta 2/2, rosca hembra BSP

Latón niquelado, NBR

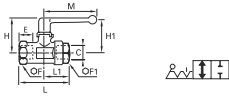

DN	C	E	F	F1	H	H1	L	L1	M	Kg	
4	G1/8	0402 04 10	8	14	35	29	44	25	48	0,094	
7	G1/8	0402 07 10	8	19	38	31	51	27	48	0,165	
	G1/4	0402 07 13	12	19	38	31	53	28	48	0,156	
10	G3/8	0402 10 17	12	24	45	43	59	31	69	0,244	
13	G1/2	0402 13 21	15	27	47	44	67	34	69	0,292	
20	G3/4	0402 20 27	16,5	32	38	63	80	39	108	0,655	
23	G1	0402 23 34	19	41	46	67	94	47	108	1,036	
32	G1 1/4	0402 32 42*	21,5	55	60	97	115	112	59	180	2,467
	G1 1/2	0402 32 49*	22	55	60	97	115	120	62	180	2,340
40	G1 1/2	0402 40 49*	22	55	55	104		111	55	190	2,445
	G2	0402 40 48*	26	70	70	104		122	61	190	2,614

* Modelos con la inscripción CE Presión máxi de servicio: 40 bar

0401 Válvula recta 2/2, rosca macho BSP y hembra BSP

Latón niquelado, NBR

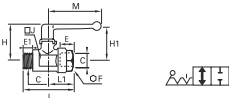

DN	C	E	E1	F	H	H1	J	L	L1	M	N	T	Kg
4	G1/8	0401 04 10	8	7	14	35	29	14	45	25	48	470	0,132
5	G1/8	0401 05 10	8	7	19	38	31	19	51	27	48	580	0,216
7	G1/4	0401 07 13	12	9	19	38	31	19	52	28	48	580	0,324
10	G3/8	0401 10 17	12	11	24	45	43	24	58	31	69	6100	0,404
13	G1/2	0401 13 21	15	12	27	47	44	27	66	34	69	8125	0,830
20	G3/4	0401 18 27	16,5	12	38	63	54	39	79	39	108	8125	1,290
23	G1	0401 23 34	19	15	46	67	57	48	91	47	108	8125	1,290
32	G1 1/4	0401 32 42*	21,5	18	60	97	115	55	113	59	108	8125	1,290

* Modelos con la inscripción CE Presión máxi de servicio: 40 bar

0414 Válvula recta 2/2 con anillo de cierre de latón

Latón niquelado, NBR

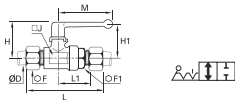

DN	ØD	F	F1	H	H1	J	L	L1	M	Kg	
4	6	0414 04 06	13	19	38	31	19	72	31	48	0,177
6	8	0414 06 08	14	19	38	31	19	74	30	48	0,180
7	10	0414 07 10	19	19	38	31	19	78	31	48	0,210
10	12	0414 10 12	22	24	45	43	24	86	36	69	0,308

Presión máxi de servicio: 40 bar

0446 Válvula recta 2/2 pasatabiques, rosca hembra BSP

Latón niquelado, NBR

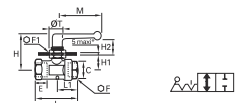

DN	C	E	F	F1	H	H1	H2	L	L1	M	T	Kg	
4	G1/8	0446 04 10*	8	14	22	37	14	12	44	25	48	16,5	0,112
7	G1/4	0446 07 13	12	19	24	45	19	14	53	28	48	20,5	0,188
10	G3/8	0446 10 17	12	24	27	50	21	21	59	31	69	20,5	0,294
13	G1/2	0446 13 21	15	27	27	51	23	21	67	34	69	20,5	0,338

Presión máxi de servicio: 20 bar * Para el modelo G1/8 : espesor máxi del tabique es de 3 mm

6402 Válvula recta 2/2 con fijación, rosca hembra BSP

Latón niquelado, NBR

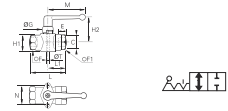

DN	C	E	F	F1	G	H1	H2	L	L1	M	N	T	Kg	
4	G1/8	6402 04 10	8	14	14	18	18	30	44	25	48	25	470	0,132
7	G1/4	6402 07 13	12	19	19	19	24	31	53	28	48	31	580	0,216
10	G3/8	6402 10 17	12	24	24	20	30	45	59	31	69	31	580	0,324
13	G1/2	6402 13 21	15	27	27	20	34	47	67	34	69	34	6100	0,404
20	G3/4	6402 20 27	16,5	32	38	27	44	52	80	39	108	43	8125	0,830
23	G1	6402 23 34	19	41	46	27	53	56	94	47	108	51	8125	1,290

Presión máxi de servicio: 40 bar

6401 Válvula recta 2/2 con fijación, rosca macho BSP y hembra BSP

Latón niquelado, NBR

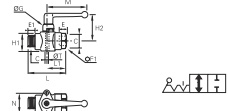

DN	C	E	E1	F	G	H1	H2	L	L1	M	N	T	Kg	
4	G1/8	6401 04 10	8	7	14	18	18	30	45	25	48	25	470	0,127
7	G1/4	6401 07 13	12	9	19	19	24	31	52	28	48	31	580	0,212
10	G3/8	6401 10 17	12	11	24	20	30	45	58	31	69	31	580	0,306
13	G1/2	6401 13 21	15	12	27	20	34	47	67	34	69	34	6100	0,394

Presión máxi de servicio: 40 bar

0472 Válvula 2/2 en codo, rosca hembra BSP

Latón niquelado, NBR

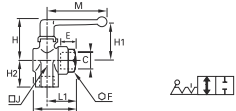

DN	C	E	F	H	H1	H2	J	L	L1	M	Kg	
4	G1/8	0472 04 10	8	14	35	29	18	14	34	25	48	0,096
6	G1/4	0472 06 13	12	19	38	31	24	22	38	28	48	0,191
9	G3/8	0472 09 17	12	24	45	43	27	25	46	31	69	0,260
12	G1/2	0472 12 21	15	27	47	44	33	29	49	34	69	0,312
18	G3/4	0472 18 27	16,5	38	59	51	40	39	60	39	108	0,704
23	G1	0472 23 34	19	46	63	55	47	48	72	47	108	1,062

Presión máxi de servicio: 20 bar

Serie universal

0471 Válvula 2/2 en codo, rosca macho BSPP y hembra BSPP

Latón niquelado, NBR

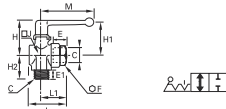

DN	C	E	E1	F	H	H1	H2	J	L	L1	M	Kg	
4	G1/8	0471 04 10	8	7	14	35	29	19	14	34	25	48	0,096
	G1/8	0471 06 10	8	7	19	38	31	22	22	37	27	48	0,182
6	G1/4	0471 06 13	12	9	19	38	31	25	22	38	28	48	0,187
9	G3/8	0471 09 17	12	11	24	45	43	28	25	46	31	69	0,256
12	G1/2	0471 12 21	15	12	27	47	44	32	29	49	34	69	0,303
18	G3/4	0471 18 27	16,5	12	38	59	51	37	39	60	39	108	0,682
23	G1	0471 23 34	19	15	46	63	55	44	48	72	47	108	1,020

Presión máx de servicio: 20 bar

0482 Válvula 3/3 en codo, rosca hembra BSPP

Latón niquelado, NBR

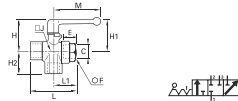

DN	C	E	F	H	H1	H2	J	L	L1	M	Kg	
4	G1/8	0482 04 10	8	14	35	29	18	14	44	25	48	0,102
6	G1/4	0482 06 13	12	19	38	31	24	22	53	28	48	0,200
9	G3/8	0482 09 17	12	24	45	43	27	25	59	31	69	0,284
12	G1/2	0482 12 21	15	27	47	44	33	29	67	34	69	0,346
18	G3/4	0482 18 27	16,5	38	59	51	40	39	80	39	108	0,742
23	G1	0482 23 34	19	46	63	55	47	48	94	47	108	1,160

Presión máx de servicio: 20 bar

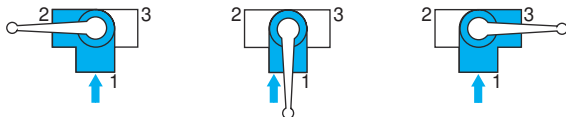

0483 Válvula de bola de ángulo recto de 3/3 sin posición cerrada, rosca hembra BSPP

Latón niquelado, NBR

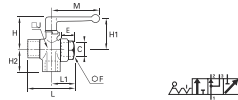

DN	C	E	F	H	H1	H2	J	L	L1	M	Kg	
4	G1/8	0483 04 10	8	14	35	29	18	14	44	25	48	0,102
6	G1/4	0483 06 13	12	19	38	31	24	22	53	28	48	0,196
9	G3/8	0483 09 17	12	24	45	43	27	25	59	31	69	0,278
12	G1/2	0483 12 21	15	27	47	44	33	29	67	34	69	0,340
18	G3/4	0483 18 27	16,5	38	59	51	40	39	80	39	108	0,716
23	G1	0483 23 34	19	46	63	55	47	48	94	47	108	1,066

Presión máx de servicio: 20 bar

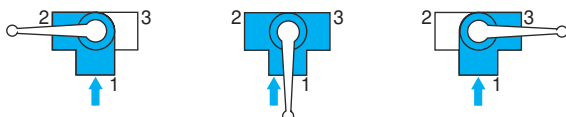

0448 Válvula 3/3 en codo pasatabiques, rosca hembra BSPP

Latón niquelado, NBR

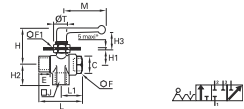

DN	C	E	F	F1	H	H1	H2	H3	J	L	L1	M	T	Kg	
4	G1/8	0448 04 10*	8	14	22	37	14	18	12.0	14	44	25	48	16,5	0,126
6	G1/4	0448 06 13	12	19	24	45	19	24	14.0	22	53	28	48	20,5	0,230
9	G3/8	0448 09 17	12	24	27	50	21	27	21.0	25	59	31	69	20,5	0,328
12	G1/2	0448 12 21	15	27	27	51	23	33	21.0	29	67	34	69	20,5	0,392

Presión máx de servicio: 20 bar * Para el modelo G1/8 : espesor máx del tabique es de 3 mm

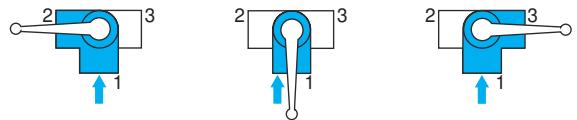

0452 Válvula 3/2 en codo en mismo plano pasatabiques, rosca hembra BSPP

Latón niquelado, NBR

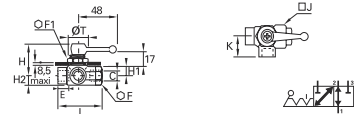

DN	C	E	F	F1	H	H1	H2	J	K	L	T	Kg	
4	G1/8	0452 04 10	8	14	22	39	10	8	16	18	25	19	0,130
6	G1/4	0452 06 13	12	19	24	40	11	11	23	24	28	20	0,206

Presión máx de servicio: 20 bar

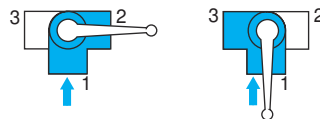

Serie universal con purga

0489 Válvula recta 3/2 con purga, rosca hembra BSPP y métrica

Latón niquelado, NBR

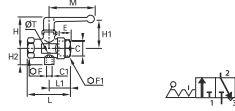

DN	C1	C	E	F	F1	H	H1	H2	L	L1	M	T	Kg
7	M5x0,8	G1/4	0489 07 13	12	24	24	46	43	17	59	31	69	2,0270
10	M5x0,8	G3/8	0489 10 17	12	24	24	46	43	17	59	31	69	2,0243
13	G1/8	G1/2	0489 13 21	15	27	27	47	44	24	67	34	69	2,0310
18	G1/4	G3/4	0489 18 27	16,5	32	38	63	54	33	80	39	108	2,50670
23	G1/4	G1	0489 23 34	19	41	46	67	57	37	94	47	108	3,1050

Presión máx de servicio: 40 bar

0462 Válvula 3/2 en codo con purga, rosca hembra BSPP

Latón niquelado, NBR

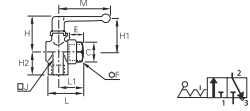

DN	C	E	F	H	H1	H2	J	L	L1	M	Kg	
6	G1/8	0462 06 10	8	19	38	31	20	22	37	27	48	0,192
	G1/4	0462 06 13	12	19	38	31	24	22	38	28	48	0,185
9	G3/8	0462 09 17	12	24	45	43	27	25	46	31	69	0,261
12	G1/2	0462 12 21	15	27	47	44	33	29	49	34	69	0,311
18	G3/4	0462 18 27	16,5	38	59	51	40	39	60	39	108	0,698
23	G1	0462 23 34	19	46	63	55	47	48	72	47	108	1,066

Presión máx de servicio: 20 bar

0449 Válvula recta 3/2 con purga, rosca hembra BSPP y métrica

Latón niquelado, NBR

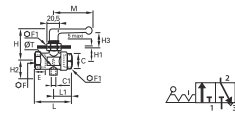

DN	C1	C	E	F	F1	H	H1	H2	H3	L	L1	M	T	Kg
7	M5x0,8	G1/4	0449 07 13	12	24	27	50	20	17	21,0	59	31	69	2,50313
10	M5x0,8	G3/8	0449 10 17	12	24	27	50	20	17	21,0	59	31	69	2,50291
13	G1/8	G1/2	0449 13 21	15	27	27	52	23	24	21,0	67	34	69	4,0352

Presión máx de servicio: 20 bar

0461 Válvula 3/2 en codo con purga, rosca macho BSPP y hembra BSPP

Latón niquelado, NBR

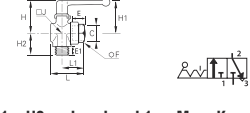

DN	C	E	E1	F	H	H1	H2	J	L	L1	M	Kg	
6	G1/8	0461 06 10	8	7	19	38	31	20	22	37	27	48	0,182
	G1/4	0461 06 13	12	9	19	38	31	24	22	38	28	48	0,186
9	G3/8	0461 09 17	12	11	24	45	43	27	25	46	31	69	0,257
12	G1/2	0461 12 21	15	12	27	47	44	33	29	49	34	69	0,304
18	G3/4	0461 18 27	16,5	12	38	59	51	40	39	60	39	108	0,648

Presión máx de servicio: 20 bar

0469 Válvula recta 3/2 con purga, rosca hembra BSPP

Latón niquelado, NBR

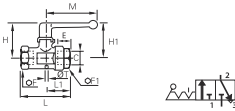

DN	C	E	F	F1	H	H1	L	L1	M	T	Kg
4	G1/8	0469 04 10	8	14	14	35	29	44	25	48	1,50092
7	G1/4	0469 07 13	12	24	24	46	43	59	31	70	2,0268
10	G3/8	0469 10 17	12	24	24	46	43	59	31	70	2,0246
13	G1/2	0469 13 21	15	27	27	47	44	67	34	70	2,0294
18	G3/4	0469 18 27	16,5	32	38	63	54	80	39	108	2,50668
23	G1	0469 23 34	19	41	46	67	57	94	47	108	3,1026

Presión máx de servicio: 40 bar

Funcionamiento de las purgas

Con purga conectado a un tubo = purga recogida, sin ruido ni contaminación

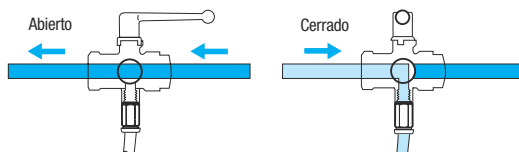

Con purga conectado a un silenciador = purga al aire libre, sin ruido

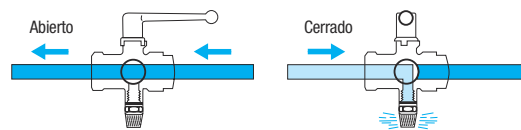

Serie universal precintable

0432 Válvula recta 2/2 precintable, rosca hembra BSPP

Latón niquelado, NBR

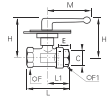

DN	C	E	F	F1	H	H1	L	L1	M	Kg
4	G1/8 0432 04 10	8	19	19	59	54	51	27	69	0,415
7	G1/4 0432 07 13	12	19	19	59	54	59	28	69	0,396
10	G3/8 0432 10 17	12	24	24	60	55	59	31	69	0,460
13	G1/2 0432 13 21	15	27	27	62	57	67	34	69	0,510
20	G3/4 0432 20 27	16,5	32	38	66	56	80	39	108	0,800
23	G1 0432 23 34	19	41	46	70	59	94	47	108	1,186

Presión máx de servicio: 40 bar

Maneta no desmontable, placa fija y placa móvil : acero zincado

0437 Válvula recta 3/2 precintable en 3 puntos con purga, rosca hembra BSPP

Latón niquelado, NBR

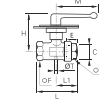

DN	C	E	F	F1	H	L	L1	M	T	Kg
7	G1/4 0437 07 13	12	24	24	60	59	32	69,5	2	0,476
10	G3/8 0437 10 17	12	24	24	60	60	32	69,5	2	0,447
13	G1/2 0437 13 21	15	27	27	60	67,5	34,5	69,5	2	0,510
18	G3/4 0437 18 27	16,5	32	38	69,5	80	39,5	108,5	2,5	0,820
23	G1 0437 23 34	19	41	46	73	94,5	47,5	108,5	3	1,192

Presión máx de servicio: 40 bar

Maneta no desmontable, placa fija y placa móvil : acero zincado

0439 Válvula recta 3/2 precintable con purga, rosca hembra BSPP

Latón niquelado, NBR

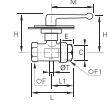

DN	C	E	F	F1	H	H1	L	L1	M	T	Kg
4	G1/8 0439 04 10	8	19	19	59	54	51	27	69	2	0,410
7	G1/4 0439 07 13	12	24	24	60	55	59	31	69	2	0,480
10	G3/8 0439 10 17	12	24	24	60	55	59	31	69	2	0,460
13	G1/2 0439 13 21	15	27	27	62	57	67	34	69	2	0,514
18	G3/4 0439 18 27	16,5	32	38	66	56	80	39	108	2,5	0,810
23	G1 0439 23 34	19	41	46	70	59	94	47	108	3	1,185

Presión máx de servicio: 40 bar

Maneta no desmontable Las placas de cierre son de acero zincado

0438 Válvula 3/2 en codo precintable en 3 puntos, rosca hembra BSPP

Latón niquelado, NBR

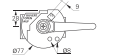
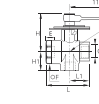

DN	C	E	F	H	H1	J	L	L1	Kg
9	G3/8 0438 09 17	12	38	76	34	39	73	35	0,970
12	G1/2 0438 12 21	15	38	76	37	39	78	38	0,947
18	G3/4 0438 18 27	16,5	38	76	40	39	80	40	0,905
23	G1 0438 23 34	19	46	80	47	48	94	47	1,295

Presión de servicio máx : 20 bar

Placa fija : acero zincado, Placa móvil : acero zincado

Maneta desmontable : en caso de un montaje de la válvula al lado de una pared, es posible desmontar la maneta y volver a montar en el entido opuesto del montaje inicial.

0436 Válvula recta 3/2 precintable en 3 puntos con purga, rosca hembra BSPP y métrica

Latón niquelado, NBR

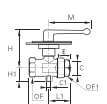

DN	C1	C	E	F	F1	H	H1	L	L1	M	Kg
10	M5x0,8	G3/8 0436 10 17	12	24	24	60	17	60	32	69	0,475
13	G1/8	G1/2 0436 13 21	15	27	27	60	24,5	67,5	34,5	69	0,500
18	G1/4	G3/4 0436 18 27	16,5	32	38	69,5	33	80	39,5	108	0,850
23	G1/4	G1 0436 23 34	19	41	46	73,5	47,5	94,5	47,5	108,5	1,215

Presión máx de servicio: 40 bar

Maneta no desmontable, placa fija y placa móvil : acero zincado

Serie universal ligera



Adecuadas para espacios pequeños, compactas y resistentes, estas válvulas de bola son fáciles de manejar.

Características técnicas

- **Fluidos adecuados:** Fluidos industriales
- **Presión de trabajo:** De vacío hasta 12 bar
- **Temperatura de trabajo:** -20°C a +80°C

Las prestaciones dependen de los fluidos utilizados.
El uso está garantizado para un vacío de 755 mm Hg (99 % de vacío).

Ventajas

- Compactación
- Resistencia a la corrosión debido al níquelado químico
- Compensación automática del desgaste de las juntas
- Manetas repositionables e intercambiables

Reglamentaciones

- PED
- REACH
- RoHS

Materiales

Sin silicona

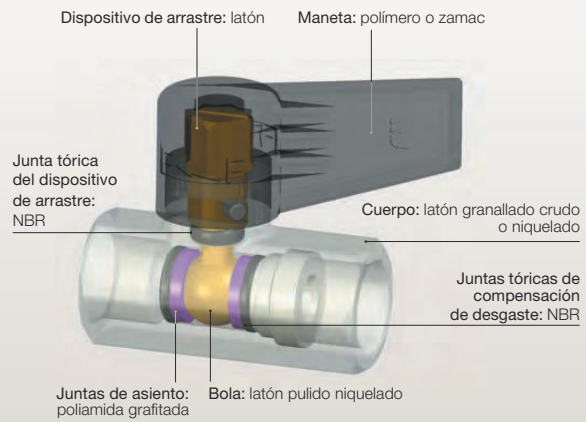

0492 Válvula recta 2/2, rosca hembra BSPP

Latón níquelado, NBR



DN	C	Artículo	E	F	H	L	L1	M	Kg
4	G1/4	0492 04 13	9	17	34	39,5	17	35	0,073
7	G3/8	0492 07 17	11	22	38	45	20	43	0,128
10	G1/2	0492 10 21	12	24	44	54	25	50	0,150
13	G3/4	0492 13 27	14	30	46	62	28	50	0,240

Maneta polímero técnico

0491 Válvula 2/2 serie ligera, rosca macho BSPP y hembra BSPP

Latón níquelado, NBR



DN	C	Artículo	E	E1	F	H	L	L1	M	Kg
4	G1/4	0491 04 13	9	7	17	34	39,5	17	35	0,070
7	G3/8	0491 07 17	11	8	22	38	45	20	43	0,124
10	G1/2	0491 10 21	12	10	24	44	53	24	50	0,160
13	G3/4	0491 13 27	14	12	30	46	59	25	50	0,238

Maneta polímero técnico

0492..64 Válvula 2/2 serie ligera, rosca hembra BSPP

Latón níquelado, NBR

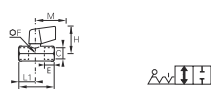

DN	C	Artículo	E	F	H	L	L1	M	Kg
4	G1/4	0492 04 13 64	9	17	36	39,5	17	25	0,090

Maneta corta en zamac

0491..64 Válvula 2/2 serie ligera, rosca macho BSPP y hembra BSPP

Latón níquelado, NBR



DN	C	Artículo	E	E1	F	H	L	L1	M	Kg
4	G1/4	0491 04 13 64	9	7	17	36	39,5	17	25	0,092

Maneta corta en zamac

Serie universal ligera

0490 Válvula recta 2/2, rosca macho BSPP

Latón niquelado, NBR

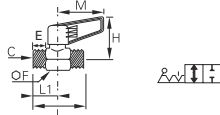

DN	C		E	F	H	L	L1	M	Kg
4	G1/4	0490 04 13	7	17	34	39	17	35	0,070
7	G3/8	0490 07 17	8	22	38	44	20	43	0,109
10	G1/2	0490 10 21	10	24	44	53	24	50	0,160
13	G3/4	0490 13 27	12	30	46	59	25	50	0,233

Maneta polímero técnico

0497 Válvula 2/2 serie ligera con eje cuadrado de arrastre, rosca hembra BSPP

Latón, NBR

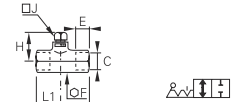

DN	C		E	F	H	J	L	L1	Kg
4	G1/4	0497 04 13	9	17	25	7	39	17	0,063
7	G3/8	0497 07 17	11	22	26	7	45	20	0,122
10	G1/2	0497 10 21	12	24	29	10	54	25	0,141
13	G3/4	0497 13 27	14	30	30	10	62	28	0,230

0494 Válvula 2/2 serie ligera con 2 tapones de purga, rosca hembra BSPP

Latón niquelado, NBR

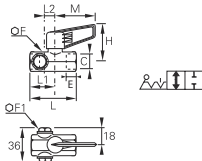

DN	C		E	F	F1	H	L	L1	L2	M	Kg
7	G3/8	0494 07 17	11	22	16	38	60	20	15	43	0,178

Maneta polímero técnico

0496 Válvula 2/2 serie ligera con eje cuadrado de arrastre, rosca macho BSPP y hembra BSPP

Latón, NBR

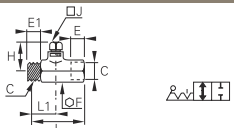

DN	C		E	E1	F	H	J	L	L1	Kg
4	G1/4	0496 04 13	7	9	17	25	7	39	17	0,065
7	G3/8	0496 07 17	8	11	22	26	7	45	20	0,118
10	G1/2	0496 10 21	10	12	24	29	10	53	24	0,150
13	G3/4	0496 13 27	12	14	30	30	10	59	28	0,222

Serie DVGW



Conforme a la certificación DVGW, con roscas estandarizadas, estas válvulas aseguran el transporte de gas y agua.

Características técnicas

- **Fluidos adecuados:** Aire comprimido, agua y gas
- **Presión de trabajo:** 1/4" a 2": 0 a 40 bar
- **Temperatura de trabajo:** de -50°C a +170°C

Las prestaciones dependen de los fluidos utilizados.
Las piezas han sido probadas a -50°C en estanqueidad estática y después de 5 maniobras para una tasa de fuga <0,05NI/h.

Ventajas

- Dispositivo de arrastre antiescape en caso de sobrepresiones
- Dos juntas a la altura del dispositivo de arrastre para reforzar la estanqueidad
- Resistencia a la corrosión, mayor compatibilidad química gracias al níquelado químico
- Puede funcionar a temperaturas muy bajas: -50°C

Presiones y temperaturas de trabajo

Presión - Temperatura

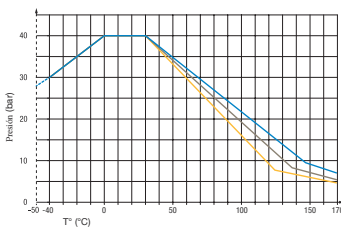

Pérdidas de carga

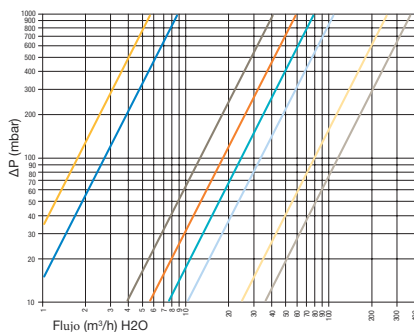

Materiales

Sin silicona

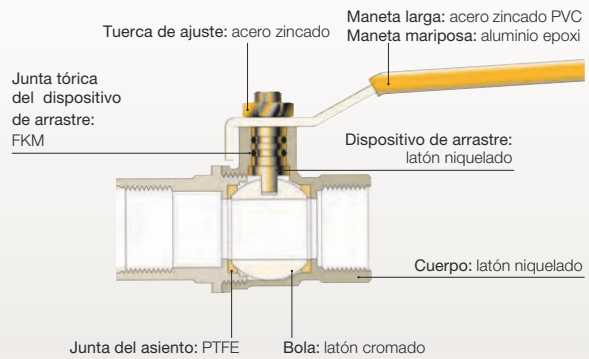

Reglamentaciones

Industriales
DI: 97/23/EC
(PED B+D module EC 1115)
Agua
DVGW: W 570-1
DIN EN 13228
BGA KTW
DVGW: W270
Gas
DIN EN 33

BVG4-L Válvula recta 2/2, rosca hembra BSPP

Latón níquelado

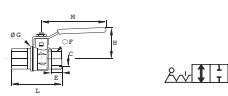

DN	C		E	F	G	H	L	M	Kg
8	G1/4	BVG4-1/4L	12	20	25	38	50	82	0,150
10	G3/8	BVG4-3/8L	12	20	25	38	60	82	0,161
15	G1/2	BVG4-1/2L	15,5	25	32,5	43	75	100	0,256
20	G3/4	BVG4-3/4L	17	32	39	50	80	120	0,397
25	G1	BVG4-1L	21	41	47,5	54	90	120	0,641
32	G1 1/4	BVG4-1.1/4L	23	50	59	73	110	158	0,980
40	G1 1/2	BVG4-1.1/2L	23	55	71,5	79	120	158	1,205
50	G2	BVG4-2L	26,5	70	86	86	140	158	1,960

BVGT4-L Válvula recta 2/2, rosca hembra BSPP

Latón níquelado

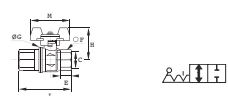

DN	C		E	F	G	H	L	M	Kg
8	G1/4	BVGT4-1/4L	12	20	25	39	50	50	0,137
10	G3/8	BVGT4-3/8L	12	20	25	39	60	50	0,129
15	G1/2	BVGT4-1/2L	15,5	25	32,5	43	75	50	0,231
20	G3/4	BVGT4-3/4L	17	32	39	47	80	60	0,348
25	G1	BVGT4-1L	21	41	47,5	51	90	60	0,546

Maneta compacta

Serie estándar



Para aplicaciones industriales comunes, estas válvulas de bola están equipadas con un sistema de cierre por juntas de fluoropolímero.

Características técnicas

Versión	Serie estándar y bloqueable	Serie compacta
Fluidos adecuados	Aire comprimido Otros fluidos: ver tabla de compatibilidad al principio de este capítulo	
Presión de trabajo	0 a 40 bar hasta 2" 0 a 30 bar más de 2' excepto BVG4P-LOCK: 0 a 14 bar	0 a 30 bar
Temperatura de trabajo	-20°C a +170°C Excepto BVG4P-LOCK: -10°C a +100°C	-10°C a +90°C

Las prestaciones dependen de los fluidos utilizados.

Ventajas

- Maneta larga o mariposa
- Paso total del fluido
- Una versión bloqueable para la seguridad en el uso
- Resistencia a la corrosión gracias al niquelado químico

Materiales

Sin silicona

Maneta larga: Acero enchapado en Geomet®
Maneta serie compacta: polímero técnico
Maneta mariposa: Aluminio

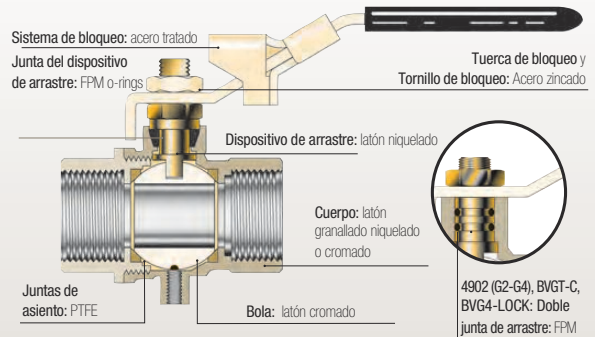

Reglamentaciones

Industriales:

- PED
- REACH
- RoHS

4902 Válvula 2/2 recta estándar, rosca hembra BSPP

Latón niquelado, PTFE



DN	C	E	F	H	L	M	PN	Kg	
8	G1/4	4902 10 13	9	20	38	39	82	40	0,131
10	G3/8	4902 10 17	9	20	38	39	82	40	0,117
15	G1/2	4902 15 21	11	25	43	50	100	40	0,204
20	G3/4	4902 20 27	12	31	50	54	120	40	0,329
25	G1	4902 25 34	14	38	54	67	120	40	0,468
32	G1 1/4	4902 32 42*	15	48	73	77	158	30	0,770
40	G1 1/2	4902 40 49*	17	54	79	90	158	30	1,040
50	G2	4902 50 48*	19	66	86	106	158	30	1,760
65	G2 1/2	4902 65 47*	22	85	132	136	255	30	4,500
80	G3	4902 80 46*	25	99	140	157	255	30	5,840
100	G4	4902 01 45*	29	125	154	191	255	30	9,040

*Modelos con la inscripción CE Modelos de 2½": doble junta de arrastre FPM y temperatura de utilización -40°C a +170°C

4991 Válvula recta 2/2 serie compacta estándar, rosca macho BSPP y hembra BSPP

Latón cromado, PTFE

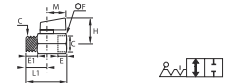

DN	C	E	E1	F	H	L	L1	M	Kg	
6	G1/8	4991 00 10	10	10	21	30	41,5	10	24	0,089
8	G1/4	4991 00 13	11	11	21	30	41,5	11	24	0,082
	G3/8	4991 00 17	11	11	21	30	41,5	10,5	24	0,087
10	G1/2	4991 00 21	13	13	25	32	49	12,5	24	0,134

4992 Válvula recta 2/2 serie compacta estándar, rosca hembra BSPP

Latón cromado, PTFE

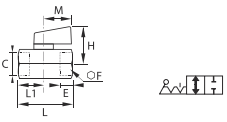





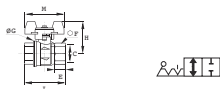

DN	C	E	F	H	L	L1	M	Kg	
6	G1/8	4992 00 10	10	21	30	41,5	10	24	0,111
8	G1/4	4992 00 13	11	21	30	41,5	11	24	0,100
	G3/8	4992 00 17	11	21	30	41,5	10,5	24	0,094
10	G1/2	4992 00 21	13	25	32	49	12,5	24	0,142

Serie estándar

BVGT4-C Válvula de bola en línea estándar 2/2, rosca hembra BSPP, mango de mariposa

Latón niquelado







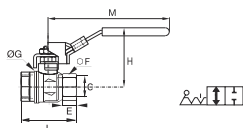

DN	C		E	F	G	H	L	M	Kg
8	G1/4	 BVGT4-1/4C	9	20	25	40	39	50	0,130
10	G3/8	 BVGT4-3/8C	9	20	25	40	39	50	0,120
15	G1/2	 BVGT4-1/2C	11	25	32,5	44	50	50	0,180
20	G3/4	 BVGT4-3/4C	12	31	39	49	54	50	0,265
25	G1	 BVGT4-1C	14	38	47,5	53	67	50	0,390

Palanca compacta
Doble sello del vástago en FPM
Temperatura de trabajo: -40°C a +170°C

BVG4-LOCK Válvula recta 2/2 precintable, rosca hembra BSPP

Latón niquelado







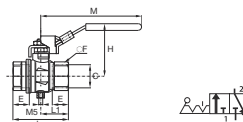

DN	C		E	F	H	L	M	Kg
8	G1/4	 BVG4-1/4LOCK	9	20	46	39	96	0,150
10	G3/8	 BVG4-3/8LOCK	9	20	46	39	96	0,150
15	G1/2	 BVG4-1/2LOCK	11	25	51	50	96	0,255
19	G3/4	 BVG4-3/4LOCK	12	31	59	54	117	0,390
25	G1	 BVG4-1LOCK	14	38	63	67	117	0,590

Doble junta de arrastrador de FPM y temperatura de trabajo de -40°C a +170 °C (de punta)

BVG4P-LOCK Válvula recta 3/2 bloqueable con purga, rosca hembra BSPP

Latón niquelado



DN	C		E	F	H	L	L1	M	Kg
8	G1/4	 BVG4P-1/4LOCK	12	20	47,5	45	22,5	96	0,155
10	G3/8	 BVG4P-3/8LOCK	12	20	47,5	45	22,5	96	0,172
15	G1/2	 BVG4P-1/2LOCK	15,5	25	52	59	29,5	96	0,239
20	G3/4	 BVG4P-3/4LOCK	17	31	59,5	64	32	117	0,371
25	G1	 BVG4P-1LOCK	21	40	63,5	81	40,5	117	0,581

Presión de trabajo: 14 bar
Temperatura de trabajo: -10°C a +100°C

Serie acero inoxidable



Para aplicaciones severas, alimentarias o procesos industriales, una serie con cuerpo de acero inoxidable 316L que soporta ambientes agresivos, así como altas presiones y temperaturas.

Características técnicas

	Tipos 4810, 4812 y 4832	Tipo 0465
Fluidos adecuados	Todos los fluidos	Todos los fluidos
Presión de trabajo	0 hasta 65 bar	De vacío hasta 20 bar
Temperatura de trabajo	-20°C a +150°C	-20°C a +120°C

Las prestaciones dependen de los fluidos utilizados.
El uso está garantizado para un vacío de 755 mm Hg (99 % de vacío).

Ventajas

- Compatibilidad química
- Operación a alta temperatura: hasta +150°C
- 3 versiones rectas:
 - El tipo compacto no puede ser desmontado
 - Las 3 piezas pueden ser desmontadas
 - Series ligeras para una mayor compactación

Materiales

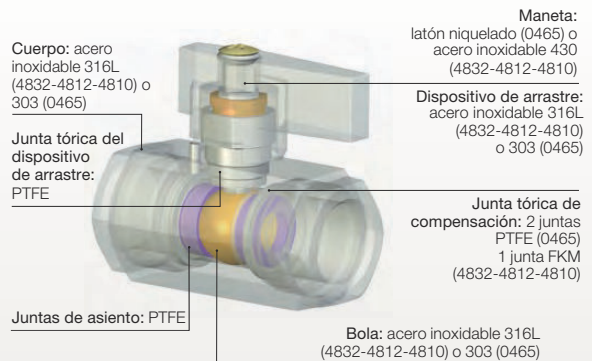

Reglamentaciones

Industriales:

- PED
- RoHS

- REACH

Resistencia a la presión y a la temperatura

Versiones 4810, 4812 y 4832

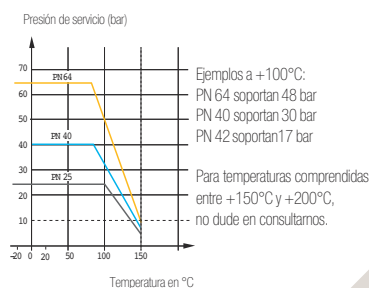

Versión 0465

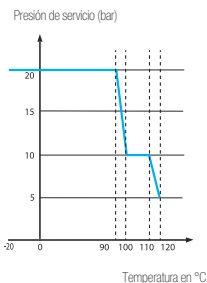

4832 Válvula recta 2/2, 3 piezas de fijación, rosca hembra BSPP

Acero inoxidable 316L, PTFE

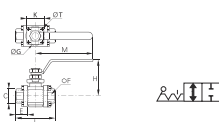

DN	C	E	F	G	H	K	L	M	T	Kg	
10	G1/4	4832 10 13**	18	22	36	50	36	57	110,5	5,5	0,272
15	G1/2	4832 15 21	20,5	27	36	64	36	65	131,5	6	0,478
20	G3/4	4832 20 27	22,5	32	42	68	42	76	131,5	5,5	0,568
25	G1	4832 25 34	27	41	42	78,5	42	92	174,5	6	1,229
32	G1 1/4	4832 32 42*	30	50	42	83,5	42	106,5	174,5	5,5	1,530
40	G1 1/2	4832 40 49*	31	55	50	100	50	116	250,5	6,5	2,146
50	G2	4832 50 48*	36	70	50	107	50	136	250,5	6,5	3,140

*Modelos con la inscripción CE
**Sin placa de fijación

4812 Válvula recta 2/2 con fijación, rosca hembra BSPP

Acero inoxidable 316L, PTFE

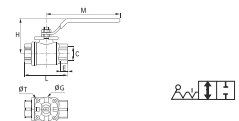

DN	C	E	G	H	L	M	T	Kg	
10	G1/4	4812 10 13	10	36	50	55	110	5,5	0,263
	G3/8	4812 10 17	11	36	50	55	110	5,5	0,254
15	G1/2	4812 15 21	15	36	53	66	110	5,5	0,336
20	G3/4	4812 20 27	16	42	67	79	130	5,5	0,574
25	G1	4812 25 34	19	42	79	93	175	5,5	1,010
32	G1 1/4	4812 32 42*	21	42	83	100	175	5,5	1,337
40	G1 1/2	4812 40 49*	21	50	100	110	250	5,5	2,161
50	G2	4812 50 48*	26	70	107	131	250	8,5	3,262

*Modelos con la inscripción CE

Serie acero inoxidable

4810 Válvula recta 2/2, rosca hembra BSPP

Acero inoxidable 316L, PTFE

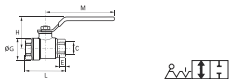

DN	C		E	G	H	L	M	Kg
8	G1/4	4810 08 13	10	30	44,5	53,5	110,5	0,206
10	G3/8	4810 10 17	10	30	44,5	53,5	110,5	0,190
15	G1/2	4810 15 21	13	32,5	47	60	110,5	0,245
20	G3/4	4810 20 27	14	40	54,5	70	131,5	0,418
25	G1	4810 25 34	17	49	58,5	79	131,5	0,648

Roscas conformes a la norma ISO 228-1

0465 Válvula recta 2/2 serie ligera, rosca hembra BSPP

Acero inoxidable 303, PTFE

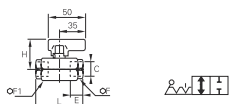

DN	C		E	F	F1	H	L	Kg
4	G1/4	0465 04 13	13	19	24	36	50	0,226
7	G3/8	0465 07 17	13	24	27	39	55	0,278
10	G1/2	0465 10 21	16	27	30	40	62	0,322

Sin silicona

Serie alta presión



Diseñadas para aplicaciones de hasta 300 bares, estas válvulas de bola cuidadosamente fabricadas garantizan un funcionamiento seguro.

Características técnicas

- **Fluidos adecuados:** Aire comprimido, lubricantes, gases
- **Presión de trabajo:** De vacío hasta 300 bar
- **Temperatura de trabajo:** -15°C a +80°C

Las prestaciones dependen de los fluidos utilizados.
El uso está garantizado para un vacío de 755 mm Hg (99 % de vacío).

Ventajas

- Bajo par de funcionamiento, incluso a alta presión
- Manetas reposicionables e intercambiables
- Diseño robusto y resistente a altos pares de apriete
- Tornillos de fijación para montaje en pasatabiques

Materiales

Sin silicona

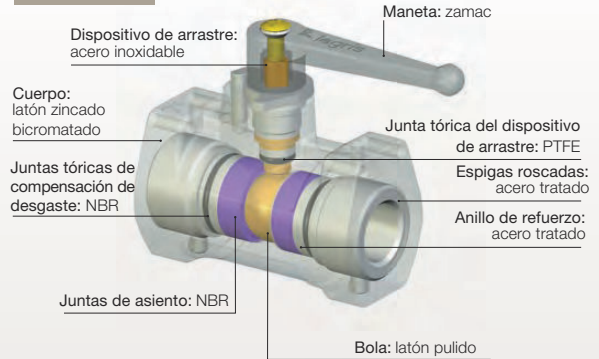

Reglamentaciones

- PED
- REACH
- RoHS

Configuraciones de instalación

Sobre placa de chapa

Fijación en pasatabiques, fijación mediante tornillo

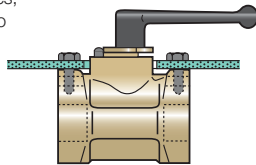

Sobre tabique

Fijación mediante codos y tornillos

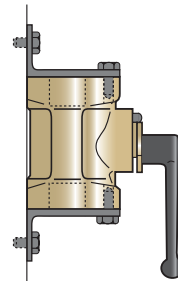

4402 Válvula recta 2/2 serie alta presión, rosca hembra BSPP

Latón tratado, NBR

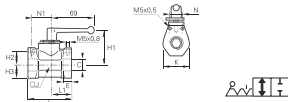

DN	C	E	H1	H2	H3	J	K	L	L1	N	N1	Kg
7	G1/4	4402 07 13	12	50	13	15.0	30	30	58	25	15	0,402
10	G3/8	4402 10 17	12	54	23	19.0	36	39	72	36	20	0,722
13	G1/2	4402 13 21	15	56	23	21.0	40	42	79	36	20	0,870

Serie mini



Equipada con conexiones instantáneas y un cuerpo de polímero técnico, esta serie combina ligereza en el equipo, velocidad de instalación.

Características técnicas

- **Fluidos adecuados:** Aire comprimido, Gases neutros
- **Presión de trabajo:** De vacío hasta 10 bar
- **Temperatura de trabajo:** -20°C a +80°C

Par de apriete	Roscas	G1/8	G1/4	G3/8	G1/2
	daN.m	0,8	1,2	3	3,5

Las prestaciones dependen de los fluidos utilizados.
El uso está garantizado para un vacío de 755 mm Hg (99 % de vacío).

Ventajas

- Ligero y compacto
- Conexiones instantáneas LF 3000®, sellado estático y dinámico
- Compensación automática del desgaste de la junta para una fiabilidad a largo plazo
- Maneta ustracompacta, fácil de manejar, ranura para destornillador de difícil acceso

Principio de funcionamiento

Válvula de purga, posición abierta

Modelo 3/2 con purga

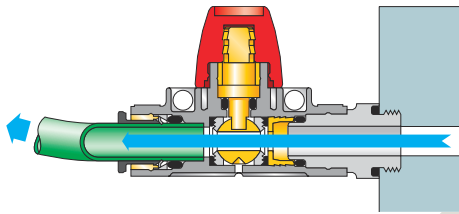

Válvula de purga, posición cerrada

Maneta con ranura para destornillar

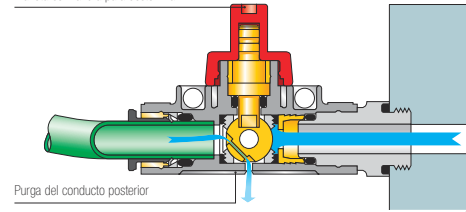

7910 Mini-válvula recta 2/2

Polímero técnico, NBR

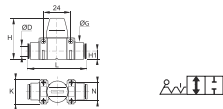

ØD		G	H	H1	K	L	N	Kg
4	7910 04 00	15	37	7,5	22	51	16	0,039
6	7910 06 00	15	37	7,5	22	52	16	0,034
8	7910 08 00	15	37	7,5	22	52	16	0,025
10	7910 10 00	20	43	11	30	66	22	0,060
12	7910 12 00	20	43	11	30	66	22	0,040

7911 Mini-válvula recta 2/2, rosca macho BSPP

Polímero técnico, latón niquelado, NBR

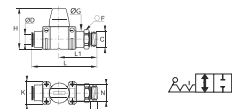

ØD	C		E	F	G	H	K	L	L1	N	Kg
6	G1/8	7911 06 10	5	13	14	37	22	62	37	16	0,045
8	G1/4	7911 08 13	5,5	16	17,5	37	22	61	35	16	0,040
10	G3/8	7911 10 17	5,5	20	22	43	30	74	41	22	0,075
12	G1/2	7911 12 21	7,5	24	26	43	30	75	42	22	0,075

Serie mini

7913 Mini-válvula recta 3/2 con purga

Polímero técnico, NBR

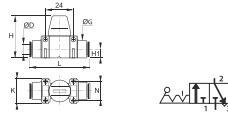

ØD		G	H	H1	K	L	N	Kg
4	7913 04 00	15	37	7,5	22	51	16	0,040
6	7913 06 00	15	37	7,5	22	52	16	0,035
8	7913 08 00	15	37	7,5	22	52	16	0,025
10	7913 10 00	20	43	11	30	66	22	0,060
12	7913 12 00	20	43	11	30	66	22	0,045

7914 Mini-válvula recta 3/2 con purga, rosca macho BSPP

Polímero técnico, latón niquelado, NBR

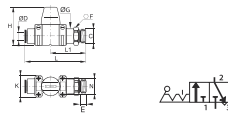

ØD	C		E	F	G	H	K	L	L1	N	Kg
6	G1/8	7914 06 10	5	13	14	37	22	62	37	16	0,045
8	G1/4	7914 08 13	5,5	16	17,5	37	22	61	35	16	0,040
10	G3/8	7914 10 17	5,5	20	22	43	30	74	41	22	0,058
12	G1/2	7914 12 21	7,5	24	26	43	30	75	42	22	0,075

7000 Agrafes de unión

Polímero técnico



ØD		Kg
4	7000 00 04	0,001
6-8	7000 00 05	0,005
10-12	7000 00 06	0,001

Productos complementarios para la serie mini

LF 3000®

Tubos PA

Tubos PU

Reguladores



LIQUIfit® de cuerpo esférico



Como parte integral de la gama LIQUIfit®, estas válvulas de bola están diseñadas para circuitos de manejo de agua y bebidas. Las normas de la FDA, NSF y WQA son una garantía de seguridad para la salud de los consumidores. Estas válvulas de bola ofrecen estanqueidad y limpieza al equipo.

Características técnicas

- **Fluidos adecuados:** Agua, bebidas, líquidos alimentarios, agua industrial, CO₂, gases neutros
- **Presión de trabajo:** 0 a 10 bar a 20°C
- **Temperatura de trabajo:** -15°C a +100°C

Ventajas

- Cuerpo de polímero técnico
- La bola autosellable de flujo completo mantiene la limpieza del circuito
- LIQUIfit® push-in conexión, sellado estático y dinámico. No hay efecto de bombeo. Resistente al golpe de ariete.

Reglamentaciones

- FDA: 21 CFR
- NSF 51

Materiales

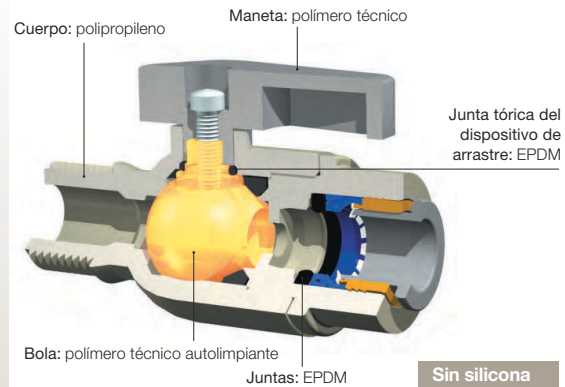

04 // Válvulas industriales

Cierre esférico

LIQUIfit® de cuerpo esférico

4020 Válvula recta 2/2 con conexión instantánea

Polipropileno con fibras de vidrio, EPDM

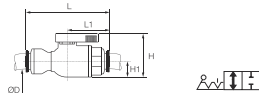

ØD		H	H1	L	L1	Kg
6	4020 06 00WP2	36	13	57	27	0,019
8	4020 08 00WP2	36	13	60	27	0,020
10	4020 10 00WP2	36	13	70	33	0,023
12	4020 12 00WP2	36,5	13	88	43	0,034

4023 Válvula recta 2/2, rosca hembra NPTF Inch

Polipropileno con fibras de vidrio, EPDM

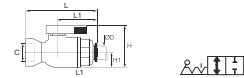

ØD	C	H	H1	L	L1	Kg
3/8	NPTF3/8	4023 60 18WP2	36	13	64	33,5 0,028

4020 Válvula recta 2/2 con conexión instantánea Inch

Polipropileno con fibras de vidrio, EPDM

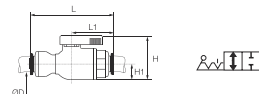

ØD		H	H1	L	L1	Kg
1/4	4020 56 00WP2	36	13	57	27	0,015
3/8	4020 60 00WP2	36	13	70	33	0,028

4022 Válvula recta 2/2, rosca hembra NPTF Inch

Polipropileno con fibras de vidrio, EPDM

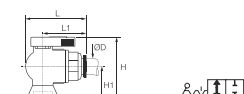

ØD	C	H	H1	L	L1	Kg
1/4	NPTF1/4	4022 56 14WP2	52	29	44	31 0,016

4021 Válvula recta 2/2, rosca macho NPTF Inch

Polipropileno con fibras de vidrio, EPDM



ØD	C	H	H1	L	L1	Kg
1/4	NPTF1/4	4021 56 14WP2	36	13	61	31 0,029
3/8	NPTF3/8	4021 60 18WP2	36	13	64	33,5 0,028

4024 Válvula en codo 2/2

Polipropileno con fibras de vidrio, EPDM

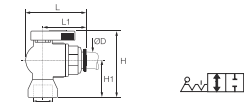

ØD		H	H1	L	L1	Kg
6	4024 06 00WP2	54	31	41	27	0,020
10	4024 10 00WP2	61	38	47	33	0,024

De punzón de latón



Hechas de latón niquelado o acero inoxidable, las válvulas de aguja están diseñadas para aplicaciones que requieren un ajuste manual del caudal.

Características técnicas

	Latón	Acero inoxidable
Fluidos adecuados	Aire comprimido, agua, fluidos industriales, etc. Otros fluidos: consúltenos	Todos los tipos de fluidos
Presión de trabajo	0 a 120 bar	0 a 400 bar
Temperatura de trabajo	-20°C a +100°C (salvo modelo 0510)	-20°C a +180°C

Las prestaciones dependen de los fluidos utilizados.

Ventajas

- Ajuste manual del caudal
- Numerosas configuraciones de válvulas y accesorios de seguridad

Materiales

Sin silicona

Tornillo de ajuste del prensaestopas:
latón niquelado o
acero inoxidable 316L (0591)

Arandela superior del prensaestopas:
latón o acero
inoxidable 316L (0591)

Cuerpo: latón granallado niquelado o acero inoxidable (0591)

Empaquetadura de prensaestopas: fibra mineral

Maneta:
zamac, latón
niquelado o acero
inoxidable 316L (0591)

Contratuercas:
latón niquelado o acero
inoxidable 316L (0591)

Punzón:
latón niquelado o
acero inoxidable
316L (0591)

Reglamentaciones

- PED
- REACH
- RoHS

0502 Grifo de punzón recto, rosca hembra BSPP

Latón niquelado

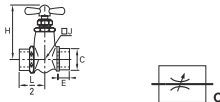

DN	C		E	H	H max	J	L/2	Kg
4	G1/8	0502 04 10	9	56	50	17	23	0,133
	G1/4	0502 04 13	11	56	50	17	23	0,120
6	G3/8	0502 06 17	12	67	60	26	0,171	
9	G3/8	0502 09 17	12	82	70	33	0,426	

0510 Grifo de punzón recto con anillo universal de latón

Latón niquelado

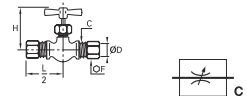

DN	ØD	C		F	H min	H max	L/2	Kg
4	6	M10x1	0510 04 06	13	42	46	29	0,083
8	8	M12x1	0510 05 08	14	42	46	30	0,083
5	10	M16x1.5	0510 05 10	19	42	46	31	0,134

Para este modelo, la estanqueidad a nivel del punzón está asegurada por una junta tórica
Presión máx.: paso 4 mm: 100 bar, paso 5 mm: 60 bar
Temperatura de utilización: -15°C a +70°C
Par de apriete: consulte el capítulo Racores de compresión

0501 Grifo de punzón recto, rosca macho BSPP y hembra BSPP

Latón niquelado

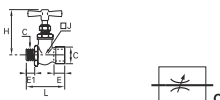

DN	C		E	E1	H	H max	J	L	Kg
4	G1/8	0501 04 10	9	7	56	50	17	44	0,118
	G1/4	0501 04 13	11	9,5	56	50	17	46	0,115
6	G3/8	0501 06 17	12	9,5	67	60	48	0,158	

0532 Grifo de punzón en codo macho-hembra, rosca BSPP

Latón niquelado

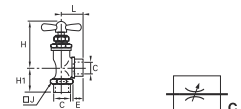

DN	C		E	H min	H max	H1	J	L	Kg
4	G1/8	0532 04 10	9	46	52	46	19	17	0,093
	G1/4	0532 04 13	11	46	52	46	21	17	0,087
6	G1/4	0532 06 13	11	55	63	55	26	22	0,171

De punzón de latón

0531 Grifo de punzón en codo, rosca macho BSPP y hembra BSPP

Latón niquelado

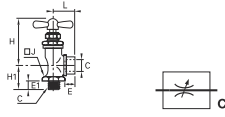

DN	C	E	E1	H min	H max	H1	J	L	Kg
4	G1/8 0531 04 10	7	9	46	52	46	19	17	0,082
	G1/4 0531 04 13	9,5	11	46	52	46	21	17	0,090
6	G1/4 0531 06 13	9,5	11	55	63	55	25	22	0,155
	G3/8 0531 06 17	9,5	12	55	63	55	25	22	0,153
10	G1/2 0531 10 21	13	16	62	72	62	34	26	0,329

0630 Válvula de seguridad con escape libre, rosca macho BSPP

Latón



C	E	F	H	Kg
G1/4 0630 06 13	9	17	42,5	0,050

Se suministra sin tarar, ya que intercalando arandelas metálicas entre las dos piezas hexagonales (F) se puede regular a comodidad.
Presión máx de servicio: 10 bar
Calibración de 1 a 10 bar (no por debajo)

0562 Grifo de punzón, rosca macho BSPP y métrica

Latón



DN	C	E	F	H min	H max	Kg
5	G1/8 0562 05 10	8	16	36	40	0,032
	G1/4 0562 05 13	10	19	38,5	42,5	0,040
	M10x1 0562 05 60	8	16	37,5	40	0,031

0591 Válvula de punzón, rosca hembra BSPP

Acero inoxidable 316L, PTFE

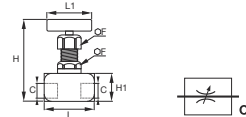

DN	C	F	H min	H max	H1	L	L1	Kg
3	G1/8 0591 03 10	22	90	99	90	25	45	0,342
4	G1/4 0591 04 13	22	90	99	90	25	50	0,354
5	G3/8 0591 05 17	22	90	104	90	30	56	0,430
6	G1/2 0591 06 21	22	90	104	90	30	62	0,478

0563 Grifo de punzón, rosca macho NPT

Latón



DN	C	F	H min	H max	Kg
5	R1/4 0563 05 14	14	28,5	32,5	0,021

0627 Grifo de manómetro con purga con maneta, rosca hembra BSPP

Latón niquelado, NBR

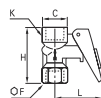

C	F	H	K	L	Kg
G1/4 0627 00 13	19	43,5	20	40	0,097

Presión = 10 bar

Es una válvula de aislamiento que permite con una simple pulsación de la maneta, leer la presión de un manómetro y purgarlo al sotaría.

Gracias a un cerrojo, podemos mantenerla conectada permanentemente

Lenticular



La válvula de mariposa permite un funcionamiento frecuente con un par muy bajo en circuitos sin zonas de retención.

Características técnicas

- **Fluidos adecuados:** Aire comprimido, fluidos abrasivos
- **Presión de trabajo:** 0 a 16 bar
- **Temperatura de trabajo:** -20°C a +80°C

Las prestaciones dependen de los fluidos utilizados.

Ventajas

- Compatible con fluidos abrasivos (incluyendo partículas sólidas)
- La dirección del flujo del fluido está marcada (unidireccional)
- Pequeño tamaño
- Diseño simple y eficiente

Materiales

Sin silicona

Dispositivo de arrastre: latón

Maneta: zamac, pintura epoxy negra

Lentícula: acero inoxidable

Cuerpo: latón granallado niquelado

Junta tórica: NBR

Reglamentaciones

- PED
- REACH
- RoHS

4602 Válvula lenticular 2/2, rosca hembra BSPP

Latón niquelado, NBR

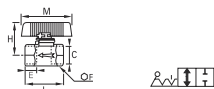

DN	C		E	F	H	L	M	Kg
6	G1/4	4602 06 13	9	17	35	34	54	0,102
7	G3/8	4602 07 17	11	22	35	39	54	0,136
10	G1/2	4602 10 21	12	24	37	42	54	0,140
13	G3/4	4602 13 27	14	30	40	49	54	0,208
18	G1	4602 18 34	15	41	46	55	54	0,412

Maneta zamac, pintura epoxy negra

Válvulas axiales



Esta válvula está equipada con un actuador neumático o electroneumático, por lo que puede ser integrada en sistemas automatizados simples.

Características técnicas

- **Fluidos adecuados:** Aire comprimido, agua, fluidos industriales. Otros fluidos: consútenos
- **Presión de trabajo:** 10 bar max.
- **Presión de pilotaje:** NC y NA : 4,2 a 8 bar
DE : 3 a 8 bar
- **Temperatura de trabajo:** -20°C a +150°C (sufijo 20 FKM)
-20°C a +150°C (sufijo 30 EPDM)

Las prestaciones dependen de los fluidos utilizados.
El uso está garantizado para un vacío de 740 mm Hg (97 % de vacío).

Ventajas

- Muy compacto
- Fácil de instalar: listo para usar
- Dos materiales de sellado (FKM, EPDM) para un mayor rango químico y de temperatura
- Neumático o electroneumático
- Tres versiones: normalmente cerrado, normalmente abierto y de doble acción

Reglamentaciones

- PED
- REACH
- RoHS

Materiales

Sin silicona

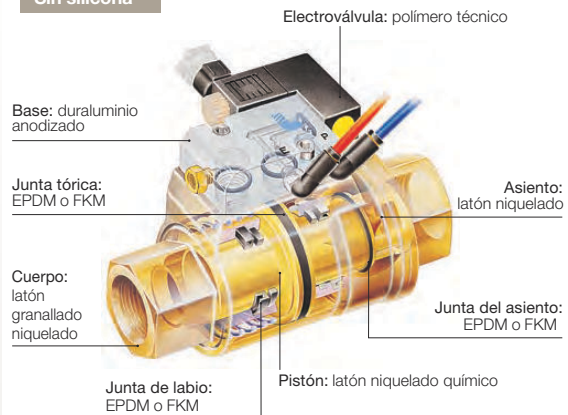

Características de caudales y pérdidas de carga (Kv)

Kv en m³/h (agua a temperatura ambiente, a una presión diferencial de 1 bar)

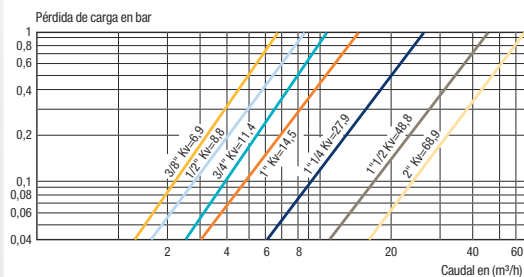

Principio de funcionamiento

En función de su posición, la pieza de conmutación atravesada por el fluido asegura la apertura o el cierre de la válvula axial.

Válvula axial normalmente cerrada (NC)

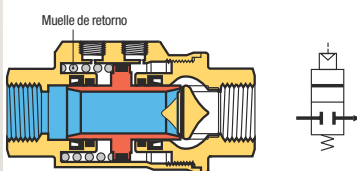

Estado reposo (válvula cerrada)

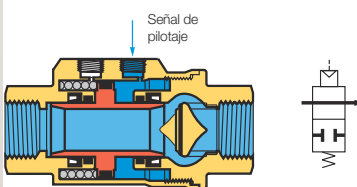

Estado pilotado (válvula abierta)

Válvula axial normalmente abierta (NA)

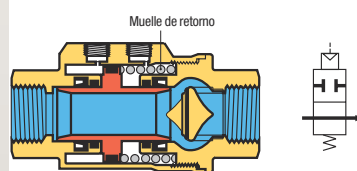

Estado reposo (válvula abierta)

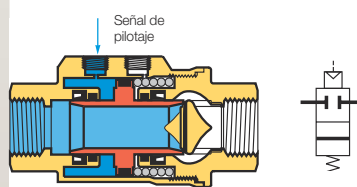

Estado pilotado (válvula cerrada)

Válvula axial de doble efecto (DE)

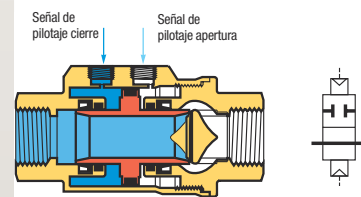

Estado pilotado (válvula cerrada)

Válvulas axiales

Configuraciones de instalación

La válvula axial Parker Legris ofrece al usuario 3 estructuras de mando distintas, en función de la instalación:

Mando neumático

Ejemplo: válvula axial 4222, de doble efecto

- un mando de proximidad en aire comprimido
- para ciclos repetitivos de apertura/cierre
- en los casos de acceso difícil a la máquina

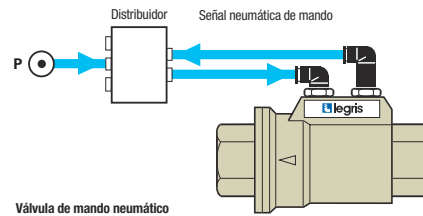

Mando electroneumático

Ejemplo: válvula axial 4202, normalmente cerrada + base y microelectroválvula 4298

- para los automatismos industriales que exigen un mando centralizado a distancia
- electroválvula plano de colocación Namur

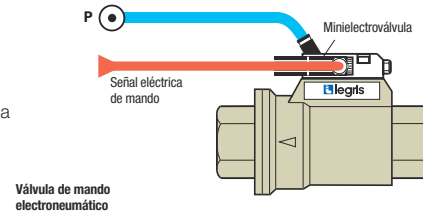

Mando mixto neumático/ electroneumático

Ejemplo: válvula axial 4212, normalmente abierta + base y microelectroválvula 4298 + botón 4299

- una estructura con doble mando
- para una seguridad elevada: impide cualquier error puntual de instalación
- electroválvula plano de colocación Namur

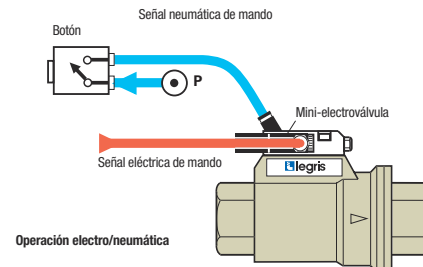

4202..20 Válvula pilotada normalmente cerrada junta FKM, rosca hembra BSPP

Latón niquelado, FKM

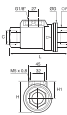

C		F	G	H	H1	L	Kg
G3/8	4202 10 17 20	22	46	54	31	98	0,834
G1/2	4202 15 21 20	27	52	60	35	112	1,075
G3/4	4202 20 27 20	33	64	70	38	135	1,624
G3/4	4202 20 27 30	33	64	70	38	135	1,606
G1	4202 25 34 20	41	69	76	41,5	143	2,033
G1 1/4	4202 32 42 20*	50	86	91	48	165	3,266
G1 1/2	4202 40 49 20*	60	96	102	54	180	4,195
G2	4202 50 48 20*	75	109	115	60,5	207	6,465

Conexión de mando: rosca G1/8
Se suministra con un silenciador
*Modelos con la inscripción CE

4202..30 Válvula pilotada normalmente cerrada junta EPDM, rosca hembra BSPP

Latón niquelado, EPDM

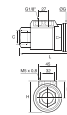

C		F	G	H	H1	L	Kg
G3/8	4202 10 17 30	22	46	54	31	98	0,818
G1/2	4202 15 21 30	27	52	60	35	112	1,071
G1	4202 25 34 30	41	69	76	41,5	143	2,013
G1 1/4	4202 32 42 30*	50	86	91	48	165	3,315
G1 1/2	4202 40 49 30*	60	96	102	54	180	4,195
G2	4202 50 48 30*	75	109	115	60,5	207	6,360

Conexión de mando : rosca G1/8
Se suministra con un silenciador
*Modelos con la inscripción CE

Válvulas axiales

4212..20 Válvula pilotada normalmente abierta junta FKM, rosca hembra BSPP

Latón niquelado, FKM

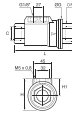

C	F	G	H	H1	L	Kg
G3/8 4212 10 17 20	22	46	54	31	98	0,824
G1/2 4212 15 21 20	27	52	60	35	112	1,096
G3/4 4212 20 27 20	33	64	70	38	135	1,637
G1 4212 25 34 20	41	69	76	41,5	143	2,025
G1 1/2 4212 40 49 20*	60	96	102	54	180	4,188
G2 4212 50 48 20*	75	109	115	60,5	207	6,555

Conexión de mando: rosca G1/8
Se suministra con un silenciador
*Modelos con la inscripción CE

4222..20 Válvula pilotada de doble efecto junta FKM, rosca hembra BSPP

Latón niquelado, FKM

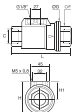

C	F	G	H	H1	L	Kg
G3/8 4222 10 17 20	22	46	54	31	98	0,802
G1/2 4222 15 21 20	27	52	60	35	112	1,042
G3/4 4222 20 27 20	33	64	70	38	135	1,571
G1 4222 25 34 20	41	69	76	41,5	143	1,942
G1 1/2 4222 40 49 20*	60	96	102	54	180	3,995
G2 4222 50 48 20*	75	109	115	60,5	207	6,275

Conexión de mando: rosca G1/8
*Modelos con la inscripción CE

4222..30 Válvula pilotada de doble efecto junta EPDM, rosca hembra BSPP

Latón niquelado, EPDM

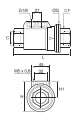

C	F	G	H	H1	L	Kg
G1/2 4222 15 21 30	27	52	60	35	112	1,046
G1 1/4 4222 32 42 30*	50	86	91	48	165	3,301

Conexión de mando: rosca G1/8
*Modelos con la inscripción CE

4298 Placa base para mando electro-neumático

Acero tratado, NBR

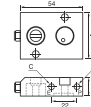

C	Kg
M5x0,8 4298 00 01	0,095

Esta placa base se monta directamente sobre las válvulas axiales 4202 y 4212.
Permite adaptar una micro-electroválvula 15 x 15
Se suministra con dos tornillos de fijación.

4298 Micro-electroválvula 1W/1,2VA

Aluminio anodizado



	Voltaje	Kg
4298 01 01	24V = CC*	0,051
4298 01 02	24V - CA**	0,058
4298 02 01	110V - CA**	0,051
4298 02 02	220V - CA**	0,054

* Corriente continua
** Corriente alterna

4299 Botón neumático

Latón niquelado, polímero técnico

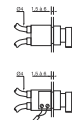

C	Kg
4299 01 01	0,090

Ø del pasatabiques 22 mm





Índice de conectores, válvulas de bola y accesorios

Referencia	Página	Referencia	Página	Referencia	Página	Referencia	Página	Referencia	Página	Referencia	Página	Referencia	Página
0101	139	0452	446	1821	175	3204	42	4222..20	465	7000	95	BPLM	159
0101..39	140	0461	447	1822	156	3206	42	4222..30	465	7010	91	BPLM-M	159
0102	144	0462	447	1823	175	3218	42	4298	465	7011	91	BVG4-L	451
0103	142	0465	455	1824	156	3226	42	4299	465	7012	92	BVG4-LOCK	453
0104	144	0469	447	1827	156	3229	41	4402	456	7020	95	BVG4-LOCK	453
0105	139	0471	446	1843	173	3266	42	4602	462	7030	95	BVG4-C	453
0106	144	0472	445	1844	173	3281	41	4810	455	7031	95	BVG4-L	451
0107	144	0482	446	1845	173	3293	42	4812	454	7040	94	C3BP	158
0108	142	0483	446	1855	173	3298	41	4832	454	7045	94	C4BP	158
0109	141	0489	447	1861	174	3299	41	4890	122	7060	92	C8BP-1	158
0110	145	0490	450	1862	174	3300	36	4891	122	7061	92	CLJP	83
0110..40	146	0491	449	1863	174	3301	176	4892	122	7062	92	COR4BP	158
0110..60	146	0491..64	449	1864	174	3303	176	4895	122	7065	92	DRV	126
0110..70	146	0492	449	1866	156	3304	29	4902	452	7067	92	EK	160
0111	145	0492..64	449	1867	174	3306	29	4991	452	7100	97	EV	160
0112	148	0494	450	1870	173	3310	29	4992	452	7101	97	F3BP	157
0114	141	0496	450	1871	173	3311	176	6101	80	7110	97	F4BP	157
0116	144	0497	450	1872	174	3312	176	6104	81	7111	97	F8BP	158
0117	168	0501	460	1873	175	3313	176	6105	80	7130	96	FF44	170
0118..39	142	0502	460	207ACBH	169	3320	36	6106	81	7140	96	FG43	170
0119	142	0510	460	207P	169	3321	37	6114	80	7160	96	HBPL	159
0119..39	143	0531	461	209P	170	3329	37	6179	80	7170	98	HP3	179
0120	147	0532	460	216P	171	3379	37	6300	46	7180	97	JBPL	159
0121	170	0562	461	218P	179	3381	37	6302	49	7190	97	MRO434	168
0122	146	0563	461	219P	178	3391	38	6304	49	7300	126	MV	160
0123	171	0591	461	222P	170	3524	35	6306	49	7630	95	R3BP	158
0124	145	0602	182	3000	70	3527	35	6307	50	7631	95	S3BP	158
0124..40	145	0605	83	3018	33	3528	35	6315	45	7640	94	WBPL	159
0125	147	0627	461	3091	38	3529	35	6316	51	7649	94		
0126	147	0630	461	3100	25	3538	34	6322	53	7660	93		
0127	148	0669	132	3101	19	3539	34	6325	46	7662	93		
0128..39	148	0670	134	3102	26	3549	34	6326	53	7665	93		
0132	150	0671	134	3103	23	3600	61	6340	50	7668	93		
0133..39	150	0672	134	3104	27	3601	60	6351	54	7669	93		
0134	150	0673	134	3106	26	3602	64	6352	46	7680	97		
0135	176	0674	133	3107	27	3603	62	6355	48	7770	94		
0136	172	0675	134	3108	23	3604	64	6366	53	7771	94		
0137	182	0676	133	3109	20	3606	64	6368	53	7772	94		
0138	81	0677	134	3110	83	3608	62	6380	52	7776	94		
0139	182	0682	134	3113	22	3609	61	6382	52	7800	132		
0142	144	0683	134	3114	20	3614	61	6383	52	7801	132		
0143	168	0900	166	3116	28	3616	65	6388	52	7802	132		
0144	168	0901	166	3118	33	3618	63	6401	445	7810	99		
0145	168	0902	167	3119	34	3620	66	6402	445	7812	99		
0151..39	148	0903	164	3120	31	3621	61	6501	45	7818	128		
0152	168	0904	165	3121	20	3622	66	6503	48	7820	100		
0155	169	0905	165	3122	32	3626	66	6505	45	7822	100		
0158	168	0906	165	3124	34	3629	62	6508	48	7828	128		
0163	169	0907	165	3126	32	3631	61	6509	47	7860	124		
0164	169	0908	164	3129	22	3636	65	6521	46	7870	124		
0165	146	0909	164	3130	82	3639	65	6579	47	7880	112		
0166	145	0910	163	3131	20	3650..33	67	6599	47	7881	112		
0167	169	0911	163	3132	24	3666	66	6801	77	7883	112		
0168	169	0912	163	3133	23	3667	66	6802	78	7885	112		
0168..39	148	0913	163	3136	28	3668	66	6804	78	7886	112		
0169	170	0914	163	3139	28	3669	62	6806	78	7892	114		
0178	164	0915	163	3140	27	3675	60	6814	77	7894	114		
0191	166	0916	163	3142	31	3681	61	6816	79	7899	116		
0192	166	0917	164	3143	31	3693	63	6826	79	7910	457		
0199	142	0919	177	3144	29	3698	63	6840	78	7911	457		
0200	178	0919..1	177	3146	28	3699	62	6866	79	7913	458		
0201	178	0920	165	3148	24	3800	73	6882	79	7914	458		
0202	179	0921	163	3149	34	3801	72	6883	79	7921	130		
0205	178	0927	164	3150..57	40	3802	75	6888	79	7926	130		
0206	180	0928	164	3150..58	40	3804	75	6899	78	7930	119		
0209	178	0929	171	3151	32	3805	71	6901	58	7931	119		
0210	180	0929..1	171	3158	24	3806	75	6903	59	7932	120		
0216	180	0931	166	3159	39	3809	73	6905	58	7960	130		
0220	147	0932	164	3160	39	3816	76	6908	59	7961	130		
0220..39	147	0933	165	3166	31	3821	72	6909	58	7970	115		
0222	177	0934	167	3168	31	3826	76	6911	55	7971	115		
0285	181	0935	167	3169	22	3831	72	6953	57	7984	118		
0400	444	0936	177	3175	18	3866	76	6958	56	7985	118		
0401	445	0950MO	167	3180	30	3879	74	6959	56	7992	121		
0402	445	0950MB	167	3181	19	3889	73	6973	57	7994	118		
0411	444	1802	155	3182	30	3893	74	6974	56	7995	118		
0414	445	1804	155	3183	30	3899	73	6975	55	7996	118		
0432	448	1805	153	3184	30	4020	459	6976	51				
0436	448	1806	155	3188	30	4021	459	6978	57				
0437	448	1809	153	3189	39	4022	459	6979	56				
0438	448	1810	156	3192	22	4023	459	6986	54				
0439	448	1814	153	3193	24	4024	459	6993	59				
0446	445	1816	155	3198	23	4202..20	464	6998	59				
0448	446	1817	173	3199	21	4202..30	464	6999	58				
0449	447	1820	154	3202	42	4212..20	465	7000	458				





Índice de tubos y pistolas de aire

Referencia	Página	Referencia	Página	Referencia	Página
0127	421	1075Y.F	404	AA13	432
0622	433	1080H	417	AA13S-01	432
0623	433	1096Y.F	404	AJ13	428
0631..01	434	1098Y.F	404	AK13	428
0631..05	434	1100H	418	AK13SE	428
0631..07	435	1100P	395	AK26SF	428
0631..09	434	1100P.R	396	AM13	428
0631..23	434	1100P.V	397	AS13	432
0651	429	1100T.P	406	AV13	432
0652	429	1100U	398	CLIP	421
0653	429	1100U..R	399	DK	423
0654	429	1100U..A	400	DS	423
0656	429	1100U..K	402	DV	423
0659	428	1100U..V	401	GI	423
0690 01	430	1100Y	404	GT	422
0690 02	430	1420U	407	KB	424
0690 03	430	1445U..R	413	KN	423
0690 04	430	1460U	413	PG../30	420
0690 05	430	1461U	413	PG../60	420
0690 06	430	1462U	413	PG../75	420
0690 06 01	430	1470P	408	PU../030	414
0690 07	430	1470U	412	PU../060	414
0690 08	431	1471P	408	PU../075	414
0690 09	431	1471U	413	PVC../050	416
0690 10	431	1472P	409	SM	423
0690 11	431	1472U	413	SP../025	409
0694	414	1827	421	SP../025/DV	410
0695	414	2003U	399	SP../025/K+S	411
0697	421	2003U..R	399	SP../050	409
1005T	405	2005P	395	SP../050/DV	410
1010P..M	407	2005U	399	SP../050/K+S	411
1010T..A	406	2005U..R	399	SP../075	409
1015Y..F	403	2010P	395	SP../075/DV	410
1025L	395	2010U	399	SP../075/K+S	411
1025P	394	2010U..R	399	SP../100	409
1025P..V	397	2299	433	SP../100/DV	410
1025T	405	3000 71 00	421	SP../100/K+S	411
1025U	398	3000 71 11	421	SP../150	409
1025U..K	402	6000 71 00	397	SP../150/DV	410
1025U..R	399			SP../150/K+S	411
1025U..V	401			SP../225	409
1025V	416			SP../225/DV	410
1025V..C	416			SP../225/K+S	411
1030Y..F	403			STD	422
1040H	417			STP	422
1050P..M	407			SU../25	420
1050T..P	406			SV	423
1050V	416			UR/UL	422

Índice de acopladores

	Perfil	DN	Series	 KF	 KA	 KB	 KL	Acopladores
Latón / Acero		1,5	Series 02		P200			Series 02
		2	Series Mini		P202	P203		Series Mini
	Alemán	2,5	Series 50		P204			Series 50
	EURO	2,7	Series 20		P206	P208		Series 20
		3	Series Mini	P211				Mini Series
		5	Series Estándar		P212			Series Estándar
	Británico	5	Series 17		P214			Series 17
	EURO	5	Series 21		P216	P219	P222	Series 21
	ARO	5,5	Series 14		P225			Series 22
	ISO C	5,5	Series 18		P227			Series 18
	Británico	5,5	Series 19		P229			Series 19
	ARO	5,5	Series 22		P231			Series 22
	ISO B	5,5	Series 24		P233			Series 23
	ISO B	5,5	Series 23		P235			Series 23
	ISO B	5,5	Series 1400		P237			Series 23
	Alemán	6	Series 52		P239	P239		Series 52
	EURO	7,2	Series 26		P241	P243		Series 25/26
	Japonés	7,5	Series 13		P245			Series 13
	EURO	7,8	Series 25		P247	P249		Series 25
	EURO	7,8	Series 1600		P251			Series 25
	EURO	7,8	Series 1625		P253			Series 25
	Escandinavo	8	Series 33		P255			Series 33
	ISO B	8,5	Series 30		P257			Series 30
	ARO	9	Series 40		P259			Series 40
	EURO	10	Series 27		P260	P261		Series 27
	EURO	10	Series 1700		P263			Series 27
	EURO	10	Series 1727		P265			Series 27
	Escandinavo	10	Series 34		P267			Series 34
	varios	10	Series 41	P269				Series 41
	ISO B	11	Series 37		P271			Series 37
Alemán	12	Series 57		P273	P273		Series 57	
Americano	15	Series 38		P275	P275		Series 38	
Americano	19	Series 39		P277	P277	P278	Series 39	
ISO 7241-1 B	4,3-20	Series 70			P280		Series 70	
Acero Inoxidable	EURO	2,7	Series 20		P281	P282		Series 20
	ISO C	3	Series 303			P284		Series 303
	EURO	5	Series 21		P286	P288		Series 21
	EURO	7,4	Series 25		P290	P291		Series 25
	EURO	10	Series 27		P293	P294		Series 27
	ISO 7241-1 B	4,3-20	Series 70			P296		Series 70

Índice de acopladores

	Perfil	DN	Series	 KF	 KA	 KB	 KL	Acopladores	
Termo-plástico		5	Series 21		P297	P297		Series 21	
		7	Series 48		P303	P303		Series 48	
		4,3-20	Series 70			P307		Series 70	
			Componentes						
Junta plana		4-9	Series 200KL				P309	Series 200	
		3-12	Series 200KLEK				P311	Series 200KLEK	
Seguridad	Estándar	5	Series 21KS		P313	P314		Series 21	
		7,8	Series 25KS		P316	P317		Series 25	
		7,4	Series 95KS		P318			Series 95	
	Aire respirable	7,4	Series 96KS		P320			Series 96	
		ISO 6150 C	5,5	Series 18KP		P322			Series 18
	Enchufes de seguridad a botón	ISO 6150 B	5,5	Series 24KP		P324			Series 23
		EURO	7,4	Series 26KP		P326			Series 25
		ISO 6150 B	8	Series 30KP		P328			Series 30
		ISO 6150 C	8	Series 84KP		P330			Series 84
	Enchufe de seguridad de corredera	ARO	5,5	Series 14KE		P332			Series 22
		ISO B	5,5	Series 1400KE		P334			Series 23
		ISO B	5,5	Series 24KE		P336			Series 23
		EURO	7,4	Series 26KE		P338			Series 25
		EURO	7,8	Series 1600KE		P340			Series 25
		EURO	10	Series 1700KE		P342			Series 27
C 9000					P344			C 9000	
Sistemas codificados		5	Series 21		P349	P350		Series 21	
		7,8	Series 25		P352	P354		Series 25	
Accesorios		Componentes							
Moldes	Accesorios Mangueras	Internacional	6 / 9 / 13	Series 86 / 87 / 88	P358	P360	P360		Series 86/87/88
		Internacional	6 / 9	Series 86 / 87 Tecnología de cierre guro	P363	P364	P364		Series 86/87/88
		Europeo	6 / 9 / 13	Series 10 / 11 / 12	P365	P367	P367		Series 10/11/12
		Europeo	6 / 9	Series 10 / 11 Tecnología de cierre guro	P370	P371	P371		Series 10/11/12
		Europeo	6 / 9	Series 10 / 11 Tecnología de cierre guro	P372	P373	P373		Series 10/11/12
		Francés	8	Series 608	P375				Series 608
		Multi-Matic	8,1	Series 93	P377			P377	Series 93
				Componentes					
Agua		12	Series Midi	P381	P381			Series Midi	
		19	Series Maxi	P384				Series Maxi	

Guía de seguridad Parker

Publicación Parker No. 4400-B.1, 28 de septiembre de 2015

Guía de seguridad Parker para seleccionar y usar mangueras, tubos, terminales y accesorios

AVISO : La rotura, selección incorrecta o uso inadecuado de mangueras, tubos, terminales, latiguillos, válvulas, conectores o accesorios ("Productos") pueden ocasionar daños materiales, lesiones personales y la muerte. La rotura, selección inapropiada o uso inadecuado de estos Productos pueden originar, entre otras, las siguientes consecuencias:

- Terminales expulsados a gran velocidad.
- Descarga del fluido a alta velocidad.
- Explosión o incendio del fluido transportado.
- Electrocuación debido a líneas de alta tensión.
- Contacto con objetos que sean controlados por el fluido y experimenten un movimiento súbito o caigan de la posición que ocupan.
- Inyección de fluido a alta presión.
- Latigazos peligrosos de mangueras.
- Estallido de tubos y tuberías.
- Rotura de uniones soldadas.
- Contacto con fluidos transportados que puedan ser tóxicos, tener una temperatura elevada o fría, o resultar nocivos por cualquier motivo.
- Chispas o explosión debido a la formación de electricidad estática u otras fuentes de electricidad.
- Chispas o explosión mientras se proyecta pintura o líquidos inflamables.
- Lesiones resultantes de inhalación, ingestión o exposición a fluidos

Antes de seleccionar o usar cualquier de estos Productos, es importante leer y seguir las instrucciones que se ofrecen a continuación. Ningún producto de ninguna división de Fluid Connector Group está aprobado para aplicaciones aeroespaciales en vuelo. Para mangueras y accesorios utilizados en aplicaciones aeroespaciales en vuelo, contacte con Parker Aerospace Group.

1.0 INSTRUCCIONES GENERALES

Alcance: esta guía de seguridad ofrece instrucciones para seleccionar y usar (incluidos el montaje, la instalación y el mantenimiento) estos productos. Para facilitar la lectura, todos los productos de caucho y/o termoplástico denominados habitualmente "manguera" o "tubería", se llaman "Manguera" en la presente guía de seguridad. Todos los conjuntos de manguera se denominan "Latiguillos". Todos los productos denominados normalmente "racores", "acoplamientos" o "adaptadores", se llaman "terminales". Las válvulas son componentes del sistema de fluidos que controlan el paso del fluido. Todos los accesorios relacionados (incluidas las máquinas y herramientas para prensar y embutir), se han denominado "Accesorios afines". La presente guía de seguridad es un complemento de las publicaciones Parker destinadas a las mangueras, terminales y accesorios afines, debiéndose utilizar conjuntamente con dichas publicaciones. Las publicaciones de Parker están disponibles en www.parker.com. Las normas SAE J1273 (www.sae.org) e ISO 17165 2 (www.ansi.org) también ofrecen prácticas recomendadas para latiguillos hidráulicos y deben seguirse.

- 1.1 Seguridad: las mangueras, los latiguillos y los terminales pueden fallar sin previo aviso por muchas razones. Diseñe todos los sistemas y equipos de forma segura, de modo que la rotura de la manguera, del latiguillo o del terminal no ocasione lesiones personales ni daños materiales.
- 1.2 Distribución: facilite una copia de esta guía de seguridad a cada persona que sea responsable de seleccionar o usar mangueras y terminales. No seleccione ni utilice mangueras ni terminales Parker sin haber leído y asimilado plenamente esta guía de seguridad así como las publicaciones específicas de los productos.
- 1.3 Responsabilidad del usuario: debido a la gran variedad de condiciones de trabajo y aplicaciones de las mangueras y terminales, Parker no garantiza que una manguera o terminal específicos resulten adecuados para cualquiera sistema dado. Esta guía de seguridad no analiza todos los parámetros técnicos que deben tenerse en consideración al seleccionar un producto. El usuario, mediante sus propios análisis y pruebas, es el único responsable de:
 - Realizar la selección final de los productos.
 - Asegurarse que se cumplen sus requisitos y que la aplicación no presenta riesgos contra la salud o la seguridad.
 - Seguir la guía de seguridad para los productos y accesorios relacionados y de ser formado para operar con los mismos.
 - Colocar los pertinentes avisos sobre salud y seguridad en el equipo donde se utilicen los productos.
 - Asegurarse de que se cumplen todas las normas gubernamentales e industrias aplicables.

- 1.4 Preguntas adicionales: si tiene alguna pregunta o necesita cualquier tipo de información adicional, llame al correspondiente departamento de servicio técnico de Parker. Vea en la publicación Parker del producto considerado o utilizado, llame al 1 800 CPARKER, o visite www.parker.com, para obtener los números de teléfono del departamento de servicio técnico.

2.0 INSTRUCCIONES DE SELECCIÓN DE MANGUERA Y TERMINAL

- 2.1 Conductividad eléctrica: en algunas aplicaciones es necesario que la manguera no sea conductora, para impedir el paso de corriente eléctrica. Otras aplicaciones requieren que la manguera y los terminales, así como la conexión manguera/terminal, sean suficientemente conductores para eliminar la electricidad estática. Se deberá tener el máximo cuidado al seleccionar mangueras y terminales para éstas y otras aplicaciones donde la conductividad o no conductividad sean un factor esencial. La conductividad o no conductividad eléctrica de la manguera y de los terminales dependen de muchos factores y pueden ser susceptibles a cambios. Estos factores incluyen, entre otros, los diversos materiales utilizados para fabricar la manguera y los terminales, al acabado del terminal (algunos acabados son conductores de electricidad, mientras que otros no lo son), (incluido el control de la humedad), la forma en que los terminales hacen contacto con la manguera, la edad y el grado de deterioro u otros cambios, el contenido de humedad de la manguera en cualquier momento específico y otros factores. A continuación, se exponen algunas consideraciones sobre las mangueras conductoras y no conductoras de electricidad. Para realizar la selección adecuada para otras aplicaciones, consulte las correspondientes páginas del catálogo, así como las normas de la industria y las normativas reglamentarias.
 - 2.1.1 Manguera no conductora de electricidad: algunas aplicaciones requieren mangueras no conductoras para evitar un flujo de corriente eléctrica o para mantener el aislamiento eléctrico. En aquellas aplicaciones donde la manguera no deba ser conductora de electricidad, incluidas, entre otras, las aplicaciones cerca de líneas de alta tensión, sólo se podrá usar una manguera no conductora especial. Deberá consultarse al fabricante del equipo donde vaya a utilizarse la manguera no conductora para confirmar que ésta y los terminales seleccionados son adecuados para dicha aplicación. No use ninguna manguera o terminal Parker para aplicaciones que requieran una manguera no conductora, por ejemplo, cerca de líneas de alta tensión, salvo que (i) la aplicación esté expresamente aprobada en la publicación técnica Parker del producto, (ii) la manguera esté marcada como "no conductora", y (iii) el fabricante del equipo donde vaya a utilizarse la manguera haya aprobado específicamente la manguera y el terminal Parker para tal uso.
 - 2.1.2 Manguera conductora de electricidad: Parker fabrica una manguera especial para determinadas aplicaciones que precisan mangueras conductoras de electricidad. Parker fabrica una manguera especial para transportar pintura en aplicaciones de pulverización "airless". Esta manguera está marcada como "Manguera Conductora de Electricidad para Pulverización de Pintura Airless" en su cuerpo y en su envase. La manguera debe ser conectada correctamente a los terminales Parker apropiados y puesta a tierra adecuadamente al objeto de disipar la peligrosa acumulación de carga estática que se produce en todas las aplicaciones de pulverización de pintura "airless". No use ninguna otra manguera, aunque sea conductora de electricidad, para la pulverización de pintura "airless". El uso de cualquier otra manguera o la conexión incorrecta de la manguera puede ocasionar incendio o explosión, con resultado de daños materiales, lesiones personales y la muerte. Parker fabrica una manguera especial para determinadas aplicaciones de gas natural comprimido (GNC) donde se puede formar electricidad estática. Los latiguillos de Parker para GNC cumplen los requisitos del ANSI/IAS NGV 4.2-1999; CSA 12.52-M99, "Mangueras para vehículos accionados por gas natural y surtidores" (www.ansi.org). Esta manguera está marcada como "Conductora de electricidad para uso GNC" en su cuerpo y en su envase. La manguera debe ser conectada correctamente a los terminales Parker apropiados y puesta a tierra adecuadamente al objeto de disipar la peligrosa acumulación de carga estática que se produce, por ejemplo, en la distribución o transferencia a alta velocidad del GNC. No use ninguna otra manguera, aunque sea conductora de electricidad, para aplicaciones de GNC donde pueda producirse una acumulación de carga estática. El uso

Guía de seguridad Parker

Publicación Parker No. 4400-B.1, 28 de septiembre de 2015

Guía de seguridad Parker para seleccionar y usar mangueras, tubos, terminales y accesorios

de otras mangueras en esta aplicación o la conexión o puesta a tierra incorrecta de esta manguera en aplicaciones GNC puede ocasionar incendio o explosión, con resultado de daños materiales, lesiones personales y la muerte. También se deberán adoptar precauciones para proteger contra la permeación del GNC a través de la pared de la manguera. Para más información, vea la sección 2.6, Permeación. La manguera Parker GNC está destinada para su uso en surtidores y vehículos a una temperatura máxima de 180°F (82°C). La manguera Parker GNC no debe utilizarse en recintos cerrados, zonas sin ventilación o zonas que superen los 180°F (82°C). Se debe realizar una prueba de fugas de los latiguillos finales. La conductividad de los latiguillos para GNC debe comprobarse mensualmente según ANSI/AS NGV 4.2-1999; CSA 12.52-M99. Parker fabrica una manguera especial para aplicaciones de vuelo. Las aplicaciones de vuelo que utilizan mangueras para suministrar el combustible, los aceites lubricantes y los fluidos hidráulicos requieren una manguera especial con un tubo interior conductor. Esta manguera para aplicaciones de vuelo sólo está disponible en la División de Productos Stratoflex de Parker. No use ninguna otra manguera Parker para aplicaciones de vuelo, aunque sea conductora de electricidad. El uso de otras mangueras en aplicaciones de vuelo o la conexión o puesta a tierra incorrecta de esta manguera, puede ocasionar incendio o explosión, con resultado de daños materiales, lesiones personales y la muerte. Estos latiguillos para aplicaciones de vuelo deben cumplir todos los requisitos aplicables de la industria aeroespacial, motores de avión y aeronaves. La selección de la manguera debe realizarse de modo que la presión máxima de trabajo de la manguera y los terminales sea igual o mayor que la presión máxima del sistema. La presión de trabajo máxima de un latiguillo es la menor de las respectivas presiones de trabajo máximas publicadas de la manguera y del terminal. Las puntas o picos transitorios de presión del sistema deben ser inferiores a la presión de trabajo máxima publicada de la manguera. Normalmente las puntas y picos transitorios de presión sólo pueden determinarse mediante instrumentos eléctricos sensibles que midan e indiquen la presión en intervalos de milisegundos. Los manómetros mecánicos sólo indican presiones medias y no pueden utilizarse para determinar puntas y picos transitorios de presión. Las presiones de rotura nominales publicadas de la manguera son únicamente para efectos de prueba de fabricación y no son una indicación de que el producto puede usarse a la presión de rotura o en aplicaciones superiores a la presión de trabajo máxima recomendada.

- 2.3 Aspiración: las mangueras utilizadas para aplicaciones de aspiración se deben seleccionar de modo que éstas resistan el vacío y la presión del sistema. Una manguera inadecuadamente seleccionada podría colapsarse en una aplicación de aspiración.
- 2.4 Temperatura: asegúrese de que el fluido y las temperaturas ambientes, tanto constantes como transitorias, no superen los límites de la manguera. Unas temperaturas por debajo o por encima del límite recomendado podrían degradar la manguera hasta el extremo de producirse su rotura y liberar el fluido. Aísle y proteja correctamente el latiguillo cuando su trazado discurre cerca de objetos calientes (por ejemplo, colectores). No utilice ninguna manguera en aplicaciones donde su rotura pueda provocar el contacto de fluidos (o vapores de fluidos transportados) con una llama, metal fundido u otra fuente de ignición capaz de causar inflamación o explosión de los fluidos transportados o vapores.
- 2.5 Compatibilidad con el fluido: la selección del latiguillo debe garantizar la compatibilidad del tubo interior, cubierta, refuerzo y terminales con el fluido utilizado. Vea la tabla de compatibilidad con fluidos en la publicación Parker del producto utilizado. Esta información se ofrece únicamente a modo orientativo. La vida de servicio real sólo podrá ser determinada por el usuario final realizando pruebas en todas las condiciones extremas y mediante otros análisis. Las mangueras compatibles químicamente con un fluido específico se deben montar usando terminales y adaptadores que contengan juntas igualmente compatibles.
- 2.6 Permeación: la permeación (es decir, la filtración a través de la manguera) se produce desde el interior al exterior de la manguera cuando ésta se utiliza con gases, combustibles líquidos y gaseosos, y refrigerantes (incluidos, entre otros, materiales como el helio, el gasóleo, la gasolina, el gas natural y el GLP). Esta permeación puede dar lugar a una alta concentración de vapores potencialmente inflamables, explosivos o tóxicos, así como a la pérdida de fluido. Si se utilizan mangueras

inadecuadas para estas aplicaciones, se pueden producir explosiones, incendios y otros peligros. El diseñador del sistema debe tener en cuenta que se producirá esta permeación, no debiéndose usar la manguera si la permeación puede resultar peligrosa. El diseñador del sistema también debe tener en consideración todas las normativas legales y de las compañías aseguradoras, así como cualesquiera otros reglamentos especiales que rijan el uso de combustibles y refrigerantes. No utilice nunca una manguera, aunque su compatibilidad con el fluido sea aceptable, sin considerar previamente los efectos peligrosos que podrían derivarse de la permeación. En las mangueras, también se producirá permeación de humedad desde el exterior al interior, con independencia de la presión interna. Si esta permeación de humedad tuviese efectos perjudiciales (particularmente en sistemas de refrigeración y de aire acondicionado), el sistema deberá ser dotado de suficiente capacidad de secado o de cualquier otra protección que resulte adecuada.

- 2.7 Tamaño: la transmisión de potencia por medio de un fluido presurizado varía con la presión y la velocidad del flujo. El tamaño de los componentes debe ser adecuado con el fin de mantener al mínimo las pérdidas de presión y evitar daños debido a la generación de calor o una velocidad excesiva del fluido.
- 2.8 Trazado: debe prestarse atención al trazado óptimo con el fin de minimizar los problemas (doblado o restricción del flujo debido al colapso de la manguera, torcimiento de la manguera, así como proximidad a objetos calientes o fuentes de calor). Para obtener otras recomendaciones sobre el trazado, consulte SAE J1273 e ISO 17165-2. Los latiguillos tienen una vida finita; si es posible, se deberán instalar de tal forma que resulte fácil realizar inspecciones y su futura sustitución. La manguera de goma, debido a su vida útil relativamente corta, no debe utilizarse en edificios residenciales y comerciales a menos que este específicamente permitido en la literatura del producto. Revise siempre toda la documentación del producto para la instalación apropiada y las instrucciones de enrutamiento.
- 2.9 Ambiente: se ha de garantizar que la manguera y los terminales sean compatibles con las condiciones ambientales a las que estén expuestos o que estén protegidos de las mismas. Las condiciones ambientales incluyen, entre otras, la radiación ultravioleta, la luz solar, el calor, el ozono, la humedad, el agua, el agua salina, los productos químicos y las partículas contaminantes del aire que pueden ocasionar degradación y fallo prematuro.
- 2.10 Cargas mecánicas: las fuerzas externas pueden reducir significativamente la vida de la manguera o producir fallos. Entre las cargas mecánicas que deben tenerse en cuenta, cabe destacar una flexión excesiva, torcimiento, doblado, cargas de tracción o laterales, radio de curvatura y vibración. Podría ser necesario usar terminales o adaptadores de tipo giratorio para que la manguera no se tuerza. En aplicaciones poco usuales podría ser necesario realizar pruebas especiales antes de seleccionar la manguera.
- 2.11 Daños físicos: se ha de tener cuidado para proteger la manguera del desgaste, rozamiento, torcimiento, curvado menor que el radio de curvado mínimo y cortes, que podrían ocasionar fallos prematuros de la misma. Cualquier manguera que esté ensortijada o se haya doblado hasta un radio menor que el radio de curvatura mínimo, así como cualquier manguera que haya sido cortada, esté rajada o presente algún daño, se deberá desmontar y desechar.
- 2.12 Terminales correctos: vea los puntos 3.2 a 3.5. Estas recomendaciones se pueden confirmar realizando pruebas de acuerdo con normas industriales como SAE J517 para aplicaciones hidráulicas, o MIL-A-5070, AS1339, o AS3517 para mangueras de la División de Productos Stratoflex de Parker para aplicaciones aeroespaciales.
- 2.13 Longitud: al establecer la longitud adecuada de la manguera, se deberá tener en consideración la absorción de movimiento, los cambios en la longitud de la manguera debido a la presión, así como las tolerancias y el movimiento de la manguera y de la máquina. Consulte el fabricante de mangueras para sus recomendaciones mínimas de longitud de manguera libre. Los conjuntos de manguera deben instalarse de manera que se produzca cualquier movimiento o flexión dentro del mismo plano.
- 2.14 Especificaciones y normas: al seleccionar mangueras y terminales, se deberán revisar y seguir las especificaciones y recomendaciones emitidas por las autoridades, la industria y Parker.
- 2.15 Limpieza de la manguera: el nivel de limpieza de los componentes de la

Guía de seguridad Parker

Publicación Parker No. 4400-B.1, 28 de septiembre de 2015

Guía de seguridad Parker para seleccionar y usar mangueras, tubos, terminales y accesorios

- manguera puede variar. Se ha de garantizar que el latiguillo seleccionado tenga un nivel de limpieza adecuado para la aplicación.
- 2.16 Fluidos resistentes al fuego: para algunos fluidos resistentes al fuego que deban transportarse a través de manguera, deberá utilizarse el mismo tipo de manguera que para fluidos a base de petróleo. Algunos de estos fluidos requieren una manguera especial, mientras que para algunos pocos no servirá ninguna manguera. Vea los puntos 2.5 y 1.5. Una manguera incorrecta puede fallar después de un tiempo de servicio muy corto. Además, todos los líquidos, excepto el agua pura, pueden arder bajo ciertas condiciones, e incluso los escapes de agua pura pueden ser peligrosos.
- 2.17 Calor radiante: la manguera se puede calentar hasta quedar destruida, aunque no haga contacto con componentes cercanos tales como colectores calientes o metal fundido. La misma fuente de calor puede dar lugar a un incendio. Esto puede suceder a pesar de la presencia de aire frío alrededor de la manguera.
- 2.18 Soldadura o soldadura por capilaridad: cuando utilice un soplete o un equipo de soldar por arco cerca de líneas hidráulicas, éstas deberán ser desmontadas o protegidas con materiales resistentes al fuego. Las llamas o las salpicaduras de soldadura podrían quemar la manguera y posiblemente inflamar el fluido, produciéndose una avería catastrófica. Cuando las piezas zincadas, incluidos los terminales y adaptadores de manguera, se calientan por encima de 450°F (232°C), por ejemplo, durante el proceso de soldadura, pueden emitir gases mortíferos. Cualquier elastómero, junta o terminal tiene que quitarse antes de la soldadura y cualquier parte metálica debe protegerse. El material de relleno de soldadura será compatible con los tubos y accesorios que se unen.
- 2.19 Radiación atómica: la radiación atómica afecta a todos los materiales utilizados en los latiguillos. Dado que se podrían desconocer los efectos a largo plazo, no exponga los latiguillos a radiación atómica.
- 2.20 Aplicaciones aeroespaciales: las únicas mangueras y terminales que pueden utilizarse en aplicaciones de vuelo son las que se encuentran disponibles en la División de Productos Stratoflex de Parker. No use ninguna otra manguera o terminal para aplicaciones de vuelo. No use ninguna manguera o terminal de la División de Productos Stratoflex de Parker junto con cualquier otra manguera o terminal, a menos que su uso haya sido aprobado expresamente por escrito por el director técnico o el ingeniero jefe de la División de Productos Stratoflex y los componentes hayan sido verificados mediante pruebas específicas realizadas por el usuario según las normas de la industria aeroespacial.
- 2.21 Liberación de los acoplamientos: Los acoplamientos con bloqueo de bola u otros accesorios con capacidad de desconexión rápida pueden desconectarse involuntariamente si son arrastrados a través de obstáculos, o si la tapa, u otro elemento de desconexión, es golpeado o desplazado lo suficiente como para causar la desconexión. Se debe considerar el uso de conexiones roscadas cuando exista la posibilidad de una desconexión accidental.
- ### 3.0 MONTAJE DE LA MANGUERA Y TERMINAL E INSTRUCCIONES DE INSTALACIÓN
- 3.1 Inspección de los componentes: antes del montaje, se debe efectuar un cuidadoso examen de la manguera y los terminales. Se debe comprobar que los componentes tengan el estilo, tamaño, referencia de catálogo y longitud correctos. Se deberá comprobar que la manguera está limpia y no presenta obstrucciones, ampollas, pérdida de cubierta, deformación, grietas, cortes o cualquier otro defecto. Inspeccione el terminal y las superficies de estanqueidad para detectar posibles rebabas, muescas, corrosión u otras imperfecciones. NO utilice ningún componente que incumpla cualquier requisito.
- 3.2 Montaje de la manguera y del terminal: no monte un terminal Parker en una manguera Parker que no esté indicada específicamente por Parker para este terminal, salvo que el montaje haya sido autorizado por escrito por el director técnico o el ingeniero jefe de la correspondiente división Parker. No monte un terminal Parker en mangueras de otros fabricantes, ni una manguera Parker en terminales de otros fabricantes, salvo que (i) el director técnico o el ingeniero jefe de la correspondiente división Parker haya autorizado el montaje por escrito, o que la combinación está expresamente aprobada en la correspondiente documentación del producto Parker específico, y (ii) el usuario verifique el montaje y la aplicación mediante análisis y pruebas. Para la manguera Parker que no se especifiquen un terminal Parker, el usuario es el único responsable de seleccionar el terminal adecuado y los procedimientos de montaje del latiguillo. Vea el punto 1.4. Para evitar la posible aparición de problemas, como fugas en el terminal o contaminación del sistema, –es importante eliminar completamente todos los residuos de la operación de corte antes de instalar los terminales. Para montar los terminales en la manguera se deben seguir las instrucciones publicadas por Parker. Estas instrucciones figuran en el catálogo Parker del terminal específico, o puede obtenerlas llamando al 1 800 CPARKER, o visitando www.parker.com.
- 3.3 Accesorios afines: no preñe ni embuta ningún terminal o manguera Parker excepto con las correspondientes mordazas y máquinas de prensar y embutir Parker y de acuerdo con las instrucciones publicadas por Parker. No preñe ni embuta terminales de manguera de otros fabricantes con una mordaza de prensar o embutir Parker a menos que esta operación haya sido autorizada por escrito por el director técnico o el ingeniero jefe de la correspondiente división Parker.
- 3.4 Piezas: no use ninguna pieza de terminales de manguera Parker (campana, espiga, inserto, etc.) excepto con las correspondientes piezas a juego Parker, y de acuerdo con las instrucciones publicadas por Parker, salvo que haya sido autorizado por escrito por el director técnico o el ingeniero jefe de la correspondiente división Parker.
- 3.5 Terminal reutilizable/permanente: no vuelva a usar ningún terminal de manguera que haya salido despedido de la manguera o que se haya extraído a la fuerza. No vuelva a usar ningún terminal de manguera permanente de Parker (prensado o embutido) ni ninguna de sus piezas. Los latiguillos completos sólo se pueden reutilizar tras una correcta inspección de acuerdo con la sección 4.0. No monte terminales en una manguera hidráulica utilizada anteriormente en una aplicación de energía de fluidos.
- 3.6 Inspección antes de la instalación: antes de la instalación se debe efectuar un cuidadoso examen del latiguillo. Inspeccione el latiguillo para detectar cualquier daño o defecto. NO utilice ningún latiguillo que incumpla cualquier requisito.
- 3.7 Radio mínimo de curvatura: la instalación de una manguera con un radio de curvatura menor que el mínimo establecido puede reducir significativamente su vida útil. Se debe evitar una doblez excesiva en la unión de la manguera al terminal. Se debe evitar cualquier curvatura durante la instalación menor que el radio de curvatura mínimo. Cualquier manguera que haya sido retorcida durante la instalación, deberá desecharse.
- 3.8 Ángulo de giro y orientación: los latiguillos deben estar instalados de tal forma que el movimiento relativo de los componentes de la máquina no produzcan torceduras.
- 3.9 Seguridad: en muchas aplicaciones, puede ser necesario sujetar, proteger o guiar la manguera para evitar que se dañe debido a una flexión innecesaria, aumentos súbitos de presión y contacto con otros componentes mecánicos. Se ha de tener cuidado para evitar que estas medidas no introduzcan una tensión adicional o puntos de desgaste.
- 3.10 Conexión correcta de las lumbreras: para conseguir una instalación adecuada del latiguillo, es necesario que la conexión de las lumbreras sea correcta, para garantizar que no se transfiera a la manguera ninguna torsión o par al apretar los terminales o durante su uso.
- 3.11 Daños externos: la instalación no será correcta si no se han corregido o eliminado las cargas de tracción, las cargas laterales, el retorcimiento, el aplanamiento, la posible abrasión así como el daño en las roscas y en las superficies de sellado. Vea el punto 2.10.
- 3.12 Comprobación del sistema: para comprobar que todo funciona correctamente y que no existen escapes, se debe eliminar todo el aire atrapado y presurizar el sistema a su máxima presión (a la máxima presión de trabajo de la manguera o por debajo). Mientras se prueba y se utiliza, el personal debe permanecer fuera de las zonas de peligro.
- 3.13 Trazado: el trazado del latiguillo se debe realizar de tal modo que, si se produjese un fallo, el escape del fluido no pueda ocasionar lesiones personales o daños materiales. Además, si el fluido entra en contacto con superficies calientes, llamas o chispas, podría producirse fuego o explosión. Vea la sección 2.4.
- 3.14 Dispositivos de protección contra pérdida a tierra: ¡ADVERTENCIA! Riesgo de incendio y descarga eléctrica: para minimizar el riesgo de incendio si el cable calefactor de un conjunto multibobinado se daña o se

Guía de seguridad Parker

Publicación Parker No. 4400-B.1, 28 de septiembre de 2015

Guía de seguridad Parker para seleccionar y usar mangueras, tubos, terminales y accesorios

instala incorrectamente, use un dispositivo de protección contra pérdida a tierra. Las corrientes de pérdida pueden ser insuficientes para disparar un disyuntor convencional. Para la protección contra pérdida a tierra, la norma IEEE 515:1989 (www.ansi.org) sobre cables calefactores recomienda el uso de dispositivos de protección contra pérdida a tierra con un nivel de disparo nominal de 30 miliamperios para "sistemas de tubería en zonas clasificadas, zonas que precisen un alto nivel de mantenimiento o zonas que puedan estar expuestas a abuso físico o atmósferas corrosivas".

4.0 INSTRUCCIONES DE MONTAJE E INSTALACIÓN DE TUBOS Y ACCESORIOS

- 4.1 Inspección de los componentes: Antes del montaje, debe realizarse una inspección minuciosa del tubo y los accesorios. Todos los componentes deben ser revisados para comprobar que el modelo, el tamaño, el material, la unión y la longitud sean correctos. Inspeccione las superficies de montaje y sellado en busca de rebabas, mellas, corrosión, falta de juntas u otras imperfecciones. No utilice ningún componente que muestre signos de no conformidad.
- 4.2 Ensamblaje de tubos y acoplamientos: No ensamble un acoplamiento Parker con tubos que no estén específicamente listados por Parker para ese acoplamiento a menos que sea autorizado por escrito por el Gerente Técnico de la División correspondiente. El tubo debe cumplir los requisitos especificados para el ajuste. Las instrucciones publicadas por Parker deben ser seguidas cuando se instalan los accesorios en el tubo. Estas instrucciones se encuentran en el catálogo Parker del producto Parker correspondiente, o llamando al 1-800-CPARKER, o en www.parker.com.
- 4.3 Accesorios: No preajuste o sujete con abrazaderas los componentes de ajuste de Parker utilizando equipos o procedimientos de otro fabricante, a menos que lo autorice por escrito el Gerente Técnico de la división Parker correspondiente. Los tubos, los componentes de los accesorios y las herramientas deben ser revisados para comprobar que el modelo, el tamaño y el material sean los adecuados. El funcionamiento y el mantenimiento de los accesorios debe ser conforme al manual de instrucciones del accesorio designado.
- 4.4 Aseguramiento: En muchas aplicaciones puede ser necesario proteger o guiar el tubo para protegerlo de los daños causados por la flexión, los golpes de presión, la vibración y el contacto con otros componentes. Hay que tener cuidado de que estos dispositivos de protección no introduzcan puntos de debilidad o desgaste adicionales.
- 4.5 Conexión correcta: La instalación correcta de la tubería ensamblada debe asegurar que no se transfiera ningún par a la tubería cuando se aprieten los accesorios o durante el uso.
- 4.6 Daños externos: La instalación correcta no está completa sin asegurarse de que las cargas de tracción, las cargas laterales, el aplanamiento, la posible abrasión, los daños a los hilos o a las superficies de sellado se corrijan o eliminen. Véase la instrucción 2.10.
- 4.7 Comprobación del sistema: Cualquier atrapamiento de aire debe ser eliminado y el sistema debe ser presurizado a la máxima presión del sistema (a la presión máxima de trabajo de toda la tubería o por debajo de ella) para verificar el funcionamiento y la ausencia de fugas. El personal debe mantenerse alejado de las zonas peligrosas durante las pruebas y las operaciones.

Rutas: El montaje de los tubos debe realizarse de tal manera que, si se produce un fallo, los fluidos que se escapen no causen lesiones personales o daños a la propiedad. Además, si el fluido entra en contacto con superficies calientes, llamas o chispas, no puede producirse un incendio o una explosión. Véase la sección 2.4

5.0 INSTRUCCIONES DE MANTENIMIENTO Y SUSTITUCIÓN DE MANGUERAS Y TERMINALES

- 5.1 Aunque se haya realizado la selección e instalación correctas, la vida de la manguera puede reducirse significativamente si no se aplica un programa de mantenimiento continuo. La frecuencia de inspección y sustitución de los productos se determinará en función de la severidad de la aplicación, el riesgo potencial de rotura de la manguera así como la experiencia con cualquier fallo de manguera en la aplicación o en aplicaciones

similares, de forma que los productos se sustituyan antes de que suceda cualquier anomalía. El usuario deberá establecer y seguir un programa de mantenimiento que incluirá, como mínimo, los puntos 5.2 a 5.7.

- 5.2 Inspección ocular de la manguera/terminal: cuando se observe cualquiera de las situaciones que se citan a continuación, será necesario parar el sistema y sustituir el latiguillo:
 - Deslizamiento del terminal en la manguera;
 - Cubierta dañada, rajada, cortada o gastada (cualquier refuerzo expuesto);
 - Manguera dura, rígida, rajada por el calor o carbonizada;
 - Terminales rajados, dañados o corroídos;
 - Fugas por el terminal o por la manguera;
 - Manguera ensortijada, aplastada, aplanada o torcida; y
 - Cubierta con ampollas, blanda, degradada o floja.
- 5.3 Inspección ocular de todos los demás componentes: los siguientes componentes deben ser apretados, reparados, corregidos o sustituidos, según proceda en cada caso:
 - Escapes por las lumbreras;
 - Exceso de suciedad acumulada;
 - Abrazaderas o protecciones desgastadas; y
 - Nivel de fluido del sistema, tipo de fluido y aire atrapado.
- 5.4 Prueba de funcionamiento: haga funcionar el sistema a la máxima presión de trabajo y compruebe la existencia de posibles fallos y fugas. Mientras se prueba y se utiliza el sistema, debe evitarse la presencia de personas en las zonas de peligro. Vea la sección 2.2
- 5.5 Intervalos de sustitución: con el tiempo, los latiguillos y las juntas elastoméricas utilizadas en terminales de manguera y adaptadores se endurecen, desgastan y deterioran debido a los ciclos térmicos y la compresión. Los latiguillos y juntas elastoméricas se deben inspeccionar y sustituir a los intervalos de sustitución específicos, en función de la vida útil anterior, las recomendaciones de las autoridades o de la industria, o cuando las averías puedan ocasionar un tiempo de paralización inaceptable, daños o riesgos de lesión. Vea la sección 1.2. La manguera y los terminales pueden estar sometidos a desgaste mecánico o químico interno producido por el fluido transportado y pueden fallar sin previo aviso. En tales circunstancias, el usuario debe determinar la vida útil del producto mediante pruebas. Vea también la sección 2.5. Vea la sección 1.2.
- 5.6 Inspección y rotura de las mangueras: la potencia hidráulica se genera mediante fluidos que circulan a una elevada presión. Las mangueras, terminales y latiguillos contribuyen a ello transmitiendo los fluidos a una elevada presión. Los fluidos a presión pueden ser peligrosos y potencialmente mortales, por lo cual se ha de tener la máxima precaución al trabajar en estas circunstancias y al manejar mangueras que transporten fluidos. De vez en cuando, los latiguillos fallarán si no se sustituyen a los intervalos correctos. Normalmente, estos fallos son el resultado de alguna forma de mala utilización, abuso, desgaste o incumplimiento del mantenimiento adecuado. Cuando fallan las mangueras, los fluidos que circulan a alta presión en su interior escapan en un chorro que puede ser visible o no visible para el usuario. El usuario no debe intentar, bajo ningún concepto, localizar la fuga tocando con sus manos ni con ninguna otra parte de su cuerpo. Los fluidos a alta presión penetrarán por la piel y ocasionarán graves daños a los tejidos y posiblemente la pérdida de alguna extremidad. Incluso las lesiones producidas por inyección de fluido hidráulico que en apariencia no entrañen gravedad, deberán ser tratadas inmediatamente por un médico que conozca los daños que dicho fluido puede ocasionar a los tejidos. Si se produjese la rotura de una manguera, detenga inmediatamente el equipo y abandone la zona hasta que se haya liberado completamente la presión del latiguillo. El hecho de parar la bomba hidráulica no garantiza que se haya eliminado la presión en el latiguillo. En los sistemas suelen emplearse válvulas antirretorno etc., que pueden retener la presión en un latiguillo incluso cuando haya dejado de funcionar la bomba o el equipo. Los orificios minúsculos en la manguera, conocidos comúnmente como poros, pueden expulsar pequeños chorros de fluido hidráulico, muy potentes y peligrosos pero difíciles de ver. Se puede tardar varios minutos o incluso horas en liberar la presión para poder examinar el latiguillo sin ningún riesgo. Una vez que la presión se haya reducido a cero, se puede desmontar el latiguillo del equipo y proceder con su examen. Si se produce la rotura de un latiguillo, éste se deberá sustituir siempre. No intente nunca parchear o reparar un latiguillo

Guía de seguridad Parker

Publicación Parker No. 4400-B.1, 28 de septiembre de 2015

que haya fallado. Si desea información sobre cómo sustituir el latiguillo, consulte a su distribuidor Parker más cercano o a la correspondiente división Parker. Nunca toque ni examine un latiguillo que haya fallado salvo que resulte obvio que la manguera ya no contiene fluido a presión. El fluido a alta presión es extremadamente peligroso y puede ocasionar lesiones graves y potencialmente mortales.

- 5.7 Juntas elastoméricas: con el tiempo, las juntas elastoméricas se endurecen, desgastan y deterioran debido a los ciclos térmicos y la compresión. Las juntas elastoméricas se deben inspeccionar y sustituir.
- 5.8 Gases refrigerantes: se debe tener cuidado especial al trabajar con sistemas de refrigeración. El escape súbito de gases refrigerantes puede producir ceguera si hacen contacto con los ojos. De igual manera, pueden ocasionar congelación u otras lesiones graves si hacen contacto con cualquier otra parte del cuerpo.
- 5.9 Gas natural comprimido (GNC): los latiguillos Parker para GNC deben ser probados después de la instalación y antes de su utilización, así como al menos una vez al mes según ANSI/IAS NGV 4.2-1999; CSA 12.52-M99 Sección 4.2 "Inspección ocular de manguera/terminal". El procedimiento recomendado consiste en presurizar la manguera y comprobar si hay fugas, así como una inspección ocular para detectar posibles daños. Precaución: para inspeccionar la manguera no deben utilizarse cerillas, velas, llamas u otras fuentes de ignición. Los líquidos empleados para la comprobación de fugas deben limpiarse después de su uso.

6.0 ALMACENAMIENTO DE LAS MANGUERAS

- 6.1 Control de envejecimiento: Las mangueras y los latiguillos deben almacenarse de forma que facilite el control del tiempo y la aplicación del proceso logístico "primero en entrar, primero en salir" según su fecha de fabricación de los latiguillos y de las mangueras. Si no existe especificación por fabricante o por las leyes locales y regulaciones se seguirán:
 - 6.1.1 La vida útil de la manguera de goma en forma masiva o manguera hecha de dos o más materiales es de 28 trimestres (7 años) a partir de la fecha de fabricación, con una extensión de 12 trimestres (3 años), si se almacena de conformidad con ISO 2230;
 - 6.1.2 La caducidad de las mangueras y latiguillos termoplásticos y de politetrafluoroetileno se considera ilimitada;
 - 6.1.3 Los latiguillos que pasen la inspección visual y el test de prueba no pueden almacenarse por más de 2 años.
 - 6.1.4 Almacenamiento: las mangueras y latiguillos almacenados no han de estar sometidos a daños que puedan reducir su vida útil prevista y deben mantenerse en un lugar fresco, oscuro y seco con los extremos tapados. Las mangueras y latiguillos almacenados no deben estar expuestos a temperaturas extremas, ozono, aceites, líquidos o vapores corrosivos, disolventes, alta humedad, roedores, insectos, luz ultravioleta, campos electromagnéticos o materiales radiactivos.

Parker se reserva el derecho de hacer cualquier cambio en el diseño y la construcción de los productos y materiales presentados en este catálogo. Nuestras dimensiones y fotos se presentan sólo a título informativo. La información sobre las normas y reglamentos no es contractual, sólo son auténticos los certificados que se entregan a petición. Entre dos impresiones, sólo se actualiza la versión online del catálogo.



Parker

Tecnologías de movimiento y control de Parker

nos guía un in-
impulso de ayudar
clientes a ser más
y a conseguir
rentabilidad
el diseño de los
sistemas para sus
es. Esto conlleva
las aplicaciones del
para más puntos
para encontrar
formas de añadir
dependientemente de
an sus necesidades
as de movimiento
Parker dispone
experiencia, la gama
tos y la presencia
anal necesarias
er ofrecerle siempre
esta. Ninguna otra
sabe más sobre las
as de movimiento y
e Parker. Si desea
más información,
0800 27 27 5374



Aeroespacial **Sectores principales**

Servicios posventa
Transporte comercial
Motores
Aviación general y comercial
Helicópteros
Vehículos de lanzamiento
Aeronaves militares
Mísiles
Generación de potencia
Transportes regionales
Vehículos aéreos no tripulados

Productos principales

Sistemas de control y productos de accionamiento
Sistemas y componentes de motores
Sistemas y componentes de transporte de fluidos
Dispositivos de atomización, suministro y medición de fluidos
Sistemas y componentes de combustible
Sistemas de inertización de depósitos de combustible
Sistemas y componentes hidráulicos
Gestión térmica
Ruedas y frenos



Control de la climatización **Sectores principales**

Agricultura
Aire acondicionado
Maquinaria de construcción
Alimentos y bebidas
Maquinaria industrial
Ciencias biológicas y medicina
Petróleo y gas
Refrigeración de precisión
Proceso
Refrigeración
Transporte

Productos principales

Acumuladores
Accionadores avanzados
Controles de CO₂
Controladores electrónicos
Secadores de filtros
Válvulas de cierre manuales
Intercambiadores de calor
Mangueras y racores
Válvulas de regulación de presión
Distribuidores de refrigerante
Válvulas de descarga de seguridad
Bombas inteligentes
Válvulas de solenoide
Válvulas de expansión termostáticas



Componentes electromecánicos **Sectores principales**

Aeroespacial
Automatización para fábricas
Ciencias biológicas y medicina
Máquinas herramienta
Maquinaria de envasados
Maquinaria para la industria papelera
Maquinaria y conversión de plásticos
Metales primarios
Semiconductores y electrónica
Textil
Hilos y cables

Productos principales

Unidades y sistemas CA/CC
Accionadores eléctricos, robots y dispositivos deslizantes de plástico
Sistemas de accionamiento electrohidrostáticos
Sistemas de accionamiento electromecánicos
Interfaces hombre-máquina
Motores lineales
Motores de velocidad gradual, servomotores, unidades y controles
Extrusiones estructurales



Filtración **Sectores principales**

Aeroespacial
Alimentos y bebidas
Plantas y equipos industriales
Ciencias biológicas
Uso marítimo
Equipos móviles
Petróleo y gas
Generación de potencia y energías renovables
Proceso
Transporte
Purificación de aguas

Productos principales

Generadores de gas analíticos
Filtros y secadores de aire comprimido
Sistemas de filtrado de aire, refrigerante, combustible y aceite para motores
Sistemas de supervisión del estado de fluidos
Filtros hidráulicos y de lubricación
Generadores de hidrógeno, nitrógeno y aire cero
Filtros de instrumentación
Filtros de membranas y de fibra
Microfiltración
Filtración de aire estéril
Desalinización de agua, filtros y sistemas de purificación



Sistemas de fluidos y gas **Sectores principales**

Plataformas elevadoras
Agricultura
Energía alternativa
Maquinaria de construcción
Sector forestal
Maquinaria industrial
Máquinas herramienta
Uso marítimo
Tratamiento de materiales
Minería
Petróleo y gas
Generación de potencia
Vehículos de recogida de basura
Energía renovable
Sistemas hidráulicos para camiones
Equipos para césped

Productos principales

Acumuladores
Válvulas de cartucho
Accionadores electrohidráulicos
Interfaces hombre-máquina
Unidades de accionamiento híbridos
Cilindros hidráulicos
Motores y bombas hidráulicos
Sistemas hidráulicos
Válvulas y controles hidráulicos
Dirección hidrostática
Circuitos hidráulicos integrados
Tomas de fuerza
Centrales hidráulicas
Accionadores giratorios
Sensores

Sistemas hidráulicos **Sectores principales**

Plataformas elevadoras
Agricultura
Energía alternativa
Maquinaria de construcción
Sector forestal
Maquinaria industrial
Máquinas herramienta
Uso marítimo
Tratamiento de materiales
Minería
Petróleo y gas
Generación de potencia
Vehículos de recogida de basura
Energía renovable
Sistemas hidráulicos para camiones
Equipos para césped

Productos principales

Acumuladores
Válvulas de cartucho
Accionadores electrohidráulicos
Interfaces hombre-máquina
Unidades de accionamiento híbridos
Cilindros hidráulicos
Motores y bombas hidráulicos
Sistemas hidráulicos
Válvulas y controles hidráulicos
Dirección hidrostática
Circuitos hidráulicos integrados
Tomas de fuerza
Centrales hidráulicas
Accionadores giratorios
Sensores

Neumática **Sectores principales**

Sectores principales

Aeroespacial
Tratamiento de materiales y cintas transportadoras
Automatización para fábricas
Ciencias biológicas y medicina
Máquinas herramienta
Maquinaria de envasados
Transporte y automoción

Productos principales

Tratamiento de aire
Racores y válvulas de bronce
Colectores
Accesorios neumáticos
Accionadores y pinzas neumáticas
Válvulas y controles neumáticos
Desconexiones rápidas
Accionadores giratorios
Mangueras de goma y termoplásticas y terminales
Extrusiones estructurales
Tubos y racores termoplásticos
Generadores, copas y sensores de vacío

Control de procesos **Sectores principales**

Sectores principales

Combustibles alternativos
Biotecnológica
Química y refinación
Alimentos y bebidas
Marítima y construcción naval
Medicina y odontología
Microelectrónica
Energía nuclear
Exploración petrolera en alta mar
Petróleo y gas
Productos farmacéuticos
Generación de potencia
Papel
Acero
Agua/aguas residuales

Productos principales

Instrumentos analíticos
Productos y sistemas de acondicionamiento de muestras analíticas
Racores y válvulas de inyección de sustancias químicas
Racores, válvulas y bombas de suministro de fluoropolímeros
Racores, válvulas, reguladores y controladores digitales de flujo de suministro de gas de alta pureza
Medidores/controladores industriales de flujo de masa
Racores de tubo permanentes sin soldadura
Reguladores y controladores de flujo industriales de precisión
Purga y doble bloque para control de procesos
Racores, válvulas, reguladores y válvulas de colector para control de procesos

Sellado y protección **Sectores principales**

Sectores principales

Aeroespacial
Procesamiento químico
Consumo
Potencia de hidráulica
Industrial
Tecnología de la información
Ciencias biológicas
Microelectrónica
Militar
Petróleo y gas
Generación de potencia
Energía renovable
Telecomunicaciones
Transporte

Productos principales

Junta dinámicas
Juntas tóricas elastoméricas
Diseño y montaje de instrumental electromédico
Protección EMI
Juntas elastoméricas extrudidas y cortadas con precisión
Junta metálicas para altas temperaturas
Formas elastoméricas homogéneas insertadas
Fabricación y montaje de productos sanitarios
Juntas de estanqueidad compuestas con metal y plástico
Ventanas ópticas blindadas
Tubos y extrusiones de silicona
Gestión térmica
Amortiguación de vibraciones

Parker en el mundo

Europa, Oriente Medio y África

AE – Emiratos Árabes Unidos,
Dubai
Tel: +971 4 8127100
parker.me@parker.com

AT – Austria, St. Florian
Tel: +43 (0)7224 66201
parker.austria@parker.com

AZ – Azerbaiyán, Bakú
Tel: +994 50 2233 458
parker.azerbaijan@parker.com

BE/NL/LU – Benelux,
Hendrik Ido Ambacht
Tel: +31 (0)541 585 000
parker.nl@parker.com

BG – Bulgaria, Sofia
Tel: +359 2 980 1344
parker.bulgaria@parker.com

BY – Bielorrusia, Minsk
Tel: +48 (0)22 573 24 00
parker.poland@parker.com

CH – Suiza, Etoy
Tel: +41 (0)21 821 87 00
parker.switzerland@parker.com

CZ – República Checa, Klecany
Tel: +420 284 083 111
parker.czechrepublic@parker.com

DE – Alemania, Kaarst
Tel: +49 (0)2131 4016 0
parker.germany@parker.com

DK – Dinamarca, Ballerup
Tel: +45 43 56 04 00
parker.denmark@parker.com

ES – España, Madrid
Tel: +34 902 330 001
parker.spain@parker.com

FI – Finlandia, Vantaa
Tel: +358 (0)20 753 2500
parker.finland@parker.com

FR – Francia, Contamine s/Arve
Tel: +33 (0)4 50 25 80 25
parker.france@parker.com

GR – Grecia, Piraeus
Tel: +30 210 933 6450
parker.greece@parker.com

HU – Hungría, Budaörs
Tel: +36 23 885 470
parker.hungary@parker.com

IE – Irlanda, Dublín
Tel: +353 (0)1 466 6370
parker.ireland@parker.com

IL – Israel
Tel: +39 02 45 19 21
parker.israel@parker.com

IT – Italia, Corsico (MI)
Tel: +39 02 45 19 21
parker.italy@parker.com

KZ – Kazajstán, Almaty
Tel: +7 7273 561 000
parker.easteurope@parker.com

NO – Noruega, Asker
Tel: +47 66 75 34 00
parker.norway@parker.com

PL – Polonia, Varsovia
Tel: +48 (0)22 573 24 00
parker.poland@parker.com

PT – Portugal
Tel: +351 22 999 7360
parker.portugal@parker.com

RO – Rumania, Bucarest
Tel: +40 21 252 1382
parker.romania@parker.com

RU – Rusia, Moscú
Tel: +7 495 645-2156
parker.russia@parker.com

SE – Suecia, Borås
Tel: +46 (0)8 59 79 50 00
parker.sweden@parker.com

SK – Eslovaquia, Banská Bystrica
Tel: +421 484 162 252
parker.slovakia@parker.com

SL – Eslovenia, Novo Mesto
Tel: +386 7 337 6650
parker.slovenia@parker.com

TR – Turquía, Estambul
Tel: +90 216 4997081
parker.turkey@parker.com

UA – Ucrania, Kiev
Tel: +48 (0)22 573 24 00
parker.poland@parker.com

UK – Reino Unido, Warwick
Tel: +44 (0)1926 317 878
parker.uk@parker.com

ZA – República Sudafricana,
Kempton Park
Tel: +27 (0)11 961 0700
parker.southafrica@parker.com

América del Norte

CA – Canadá, Milton, Ontario
Tel: +1 905 693 3000

US – EE UU, Cleveland
Tel: +1 216 896 3000

Asia y el Pacífico

AU – Australia, Castle Hill
Tel: +61 (0)2-9634 7777

CN – China, Shanghai
Tel: +86 21 2899 5000

HK – Hong Kong
Tel: +852 2428 8008

IN – India, Mumbai
Tel: +91 22 6513 7081-85

MY – Malasia, Shah Alam
Tel: +60 3 7849 0800

JP – Japón, Tokyo
Tel: +81 (0)3 6408 3901

KR – Corea, Seúl
Tel: +82 2 559 0400

NZ – Nueva Zelanda, el Monte
Wellington
Tel: +64 9 574 1744

SG – Singapur
Tel: +65 6887 6300

TH – Tailandia, Bangkok
Tel: +662 186 7000

TW – Taiwán, Taipei
Tel: +886 2 2298 8987

América del Sur

AR – Argentina, Buenos Aires
Tel: +54 3327 44 4129

BR – Brasil, Sao Jose dos Campos
Tel: +55 800 727 5374

CL – Chile, Santiago
Tel: +56 2 623 1216

MX – México, Toluca
Tel: +52 72 2275 4200

Ed. 11-2020